



# Sign-in-China.com

Online Wholesale for AD & Signage Products

2014 - 2015

## BUYERS GUIDE TOTAL PRODUCT COLLECTION LIST

- P013 | INKJET PRINTING PRODUCTS
- P199 | ENGRAVING PRODUCTS
- P273 | POP & EXHIBIT DISPLAYS
- P313 | LED PRODUCTS
- P337 | PHOTO STUDIO
- P357 | ADVERTISING BOARDS
- P365 | ADVERTISING SIGN MAKING



APP for iOS



APP for Android



QUALITY



SECURE



FAST

**YOUR FIRST CHOICE WEBSITE FOR AD & SIGNAGE PRODUCTS!**

# Easy 4 Steps to Check Out Online

Only 4 steps to finish your online orders. Try Now!



- 1 Browse categories
- 2 Add items to your cart
- 3 Go to checkout
- 4 Wait for delivery

http://www.sign-in-china.com/



**Sign-in-China**  
Online Wholesale for AD & Signage Products

[Home](#) | [Select Language](#) | [Sign in or register](#) | [My Account](#) | [Info](#) | [Follow us:](#) [f](#) [t](#)

[Shop All Departments](#)

Cart 0 Item(s)

- AD and Sign Equipment >
- Printer Heads & Parts >
- Materials and Inks >
- POP and Exhibit Displays >
- LED Products >
- Photo Studio >
- Advertising Sign Making >
- Tools & Accessories >
- Promotions >

**FREE Shipping**

**Sample Products**  
Only \$0.1

**Highly Recommended**

**Container Order**

**For Resellers**

**100% Compatible With Original Ink**  
**Saving Your Cost!**

**Quick News & Promotions** [More>>](#)

- Flash Wholesale! Reduce Cost May 25
- Special Coupons and Gifts in May 25
- Gift \$30 Material Sample Book May 15
- \$0.99 Ink Cartridge 2 pcs Left! May 14
- Calca 100% Compatible With May 05

Save up to 60%

Closeout Deals

**Top Selling Products** [More>>](#)



Brand New Epson Stylus Photo

\$142.84 - 155.26/pc  
[Ships to China](#)



10ft Straight Fabric Display Wall (Graphics)

\$295.45 - 311.00/set  
[Ships to China](#)



A3 Size Portable Vinyl Cutter and Plotter with

\$238.01 - 264.46/set  
[Ships to China](#)













36" (0.914m\*30m) Printing Media Solvent

\$160.82 - 169.39/roll  
[Ships to China](#)



0.2w 3 SMD Waterproof LED Module, White

\$0.30 - 0.40/pc  
[Ships to China](#)

Limited Time Offers	Flash Wholesale	New Arrivals
 <p>Semi-automatic Grommet Machine</p> <p>\$348.00 - 396.00/set <a href="#">Ships to China</a></p>	 <p>Flex Banner Cutter</p> <p>\$13.82 - 15.70/pc <a href="#">Ships to China</a></p>	 <p>Stretching Canvas Pliers for Stretching Canvas</p> <p>\$6.95 - 9.26/pc <a href="#">Ships to China</a></p>
 <p>Stainless Steel Staples for Staple Gun</p> <p>\$2.51 - 3.14/parcel <a href="#">Ships to China</a></p>	 <p>Heavy-duty U Shape Stainless Steel Staple</p> <p>\$10.58 - 13.22/pc <a href="#">Ships to China</a></p>	
 <p>Calca Compatible 440ML Mimaki SS21 ECO Ink</p> <p>\$35.64 - 44.99/pc</p>	 <p>General Manual Adhesive Silicone Gun</p> <p>\$5.85 - 7.44/pc</p>	 <p>High Quality Manual Glass Glue Gun Caulk</p> <p>\$2.98 - 3.72/pc</p>
 <p>39.4" x 78.8" Outdoor Double Sides Adjustable</p> <p>\$55.25 - 85.00/set</p>	 <p>39.4"(1m*30m) Printable Media Plain Brown</p> <p>\$197.32 - 207.70/roll</p>	

**Recently Reviews**

- 

Roland XC-540 Big Damper with Big

\$1.93 - 2.84/pc  
★★★★★ (3 Reviews)
- 

Roland FJ-740 Printhead Small

\$2.05 - 3.01/pc  
★★★★★ (4 Reviews)
- 

Epson DX4 Head Small Damper with

\$2.05 - 3.04/pc  
★★★★★ (2 Reviews)
- 

Epson Stylus Pro 4880 Roll Ink

\$51.09 - 60.10/set  
★★★★★ (9 Reviews)
- 

Mimaki JV33/JV5 Cap Capping Top

\$13.13 - 17.99/pc  
★★★★★ (4 Reviews)
- 

Roland FJ-740 Small Damper with

\$2.05 - 3.01/pc  
★★★★★ (2 Reviews)
- 

Roland Scan Motor for

\$298.32 - 339.00/pc  
★★★★★ (3 Reviews)
- 

Epson Stylus Pro 4800/7800 Network

\$37.60 - 44.24/pc  
★★★★★ (3 Reviews)
- 

100 pcs Swab Cleaning for

\$12.80 - 17.53/parcel  
★★★★★ (4 Reviews)



Video Guide

# One Stop Solution for Your FOB Purchase

Factory 1  
Factory 2  
Factory 3  
Factory 4  
Factory 5 ...

Quality?  
Shipping?  
Service?

Safety?  
Price?...

It's just that  
**EASY** and **QUICK**  
to ship by sea  
NOW!

**Warranty**  
Quality production by famous OEM manufacturers.

**Diversification**  
Online one-stop solution shopping with diversified products & maximize container space.

**Pricing**  
Transparent & competitive prices of same quality products on market.

**Logistics**  
Quick logistics service with instant quoting for more than 360 ports worldwide.

**Team**  
Professional service for bulk purchase, quality control as well as packing.

- 1 Add items to your container.
- 2 Adjust your container and submit a pre-order.
- 3 Wait for your order confirmation and make the payment.

**Container Order**

\* Vehicle:  CE  20' General Purpose Container  40' Dry Freight Container  40' High Cube Dry Freight Container

\* Destination: United States (select a port) - Los Angeles - Gen: 02100

Payment: Bank Transfer (T/T)

Message: Special Instructions or Order Comments

Container preview: **20' General Purpose Container**

99% 25.97m<sup>3</sup>

Our sales representatives will contact you to confirm your order details and optimize it for your use. ATTENTION: Please don't preface payment before our confirmation.

Item Title	Min. Order	Quantity / Price	Amount
61000-0-1000'1000-10'14' Front End Stamp 3.57(1.96) 3542-200	30 rolls	145 roll <a href="#">Update</a> \$342/roll	\$49,690.00 Revenue
921 50L Solvent Ink 4739009	22 bottles (5L / bottle)	64 bottle <a href="#">Update</a> \$51.75/bottle	\$3,312.00 Revenue
A3+ LED UV Flatbed Printer 16049100	1 set	1 set <a href="#">Update</a> \$8,978.00	\$8,978.00 Revenue

Subtotal (3 items) \$62,980.00  
Shipping charge \$2100  
Volume: 25.97 m<sup>3</sup>  
Shipping Weight: 19,688 Kg

**Total: \$64,981**

[Continue shopping](#) [Submit Order](#)



Instant quoting for more than 360 ports worldwide.

# We are Inviting Partners From All Over the World to Join Us Now!



**We will offer direct discounts and more supports for our reseller clients:**

- Up to 15% discount on the basis of competitive wholesale price for all your orders.
- Free marketing analysis and data support.
- Professional supports to all your questions.

**How can I become a reseller?**

Please submit your application form via the following URL: <http://www.sign-in-china.com/reseller/>



## Why Choose Us?

### 1. High Quality Product Collection

- Product Expert Team with 18 Years of Experience
- Customer Commenting Mechanism
- Two-Year Warranty for All the Equipment
- Supported by Famous OEM Manufactures

### 2. Convenient & Fast Online Shopping Experience

- One Stop Solutions for All Catageries
- Easy-to-Use Online Ordering System
- Real-time Online Order Tacking
- Multiple Payment Methods

### 3. Let You Decide the Prices

- Stepped Prices for Different Quantities
- You Decide the Prices for Bulk Orders
- Enjoy Membership Points, Coupons and Limited Time Offers

### 4. Safe Cross Border Transactions

- Free Shipping Insurance for Every Order
- Transparent Return & Exchange Policy
- Offer Local Pick-up Service for Some Areas



# More Discounts:



# My Account:

**Sign-in-China**  
Online Wholesale for AD & Signage Products

Home | Selected Language | My Points: 1740 | Hello, David | My Account | Sign out | Site | Follow us: | Live Chat

Shop All Departments | Search by keyword or Item Code# | Search | Cart 1 Item(s)

Home > My Account

**My Account**

**My Information**

In Box (0)

**Order Center**

My Orders  
Questions  
My Inquiries  
Bulk order  
Wish List  
Discount Notice

**Account Center**

Account Settings  
My Level  
Membership Points  
Coupon  
Shipping Address Book

**Customer Service**

Complaints And Suggestions

**My Account**

**\$30 Coupon for Calca Ink**  
Code: SICCALCA

Wang (wangdm@chinainsigns.cn)

Basic Member. You have totally spent USD \$0. If spend USD \$3,000 more, you will upgrade to Silver Member.

Order Reminder: Pending Orders(7)  
My Interest: Discount Notice(0) | Promotions | New Arrivals  
Site Alert: Questions(0) | My Inquiries(0)

Account Balance: USD \$ 17.4  
My Points: 1,740

**You May Like Following Products**

Seiko SP1602E35PL Printhead	Calca Compatible 40ML Roland ECO Sol	Manual Grommet Tool Eyelet Puncher 3 Free	7mm x 15mm Waterproof LED	45 Degree Roland Vinyl Plotter Cutter
\$1,736.00/pc	\$44.99/pc			

**Video Guide**

## Buyer Protection

- ✓ Shipping Safety (Receive your items 100% in good condition)
- ✓ Full Money Back Guarantee (if no goods received)



### Shipping Safety (Receive your items 100% in good condition)

We guarantee your products that ordered to arrive in good condition. Sign-in-China.com will make shipping insurance for any shipment. We will resend you new items or give a full refund if you fail to get your order.



### Full Money Back Guarantee (If your delivery is late)

We will give you a FULL REFUND if your order does not arrive within the stated delivery time.



# CONTENTS

## 01 / INKJET PRINTING PRODUCTS

### **P014 | Large Format Printer**

### **P025 | 3D Printer & Accessories & Supplies**

### **P027 | Heat Transfer Machine**

P027 | Large format heat transfer machine

P028 | 3D vacuum heat press machine

P030 | Combo heat press machine

P032 | T - shirt heat transfer machine

P043 | Mug & plate heat transfer machine

P048 | Badge making machine

P050 | Heat press starter kit

P052 | Heat press accessories & badge mold

### **P053 | Flatbed Printer & Supplies**

### **P059 | Flag Making Machine**

### **P061 | Laminator & Finishing Equipments**

P061 | Wide format roll laminator

P074 | Liquid laminator

P076 | Vinyl banner slitter & welder

P082 | Slot puncher and paper trimmer

P085 | Grommet machine

### **P089 | Flower & Nail Art Printer**

### **P092 | Inkjet Printhead**

### **P097 | Printer Spare Parts**

P097 | Epson printer spare parts

P107 | Roland printer spare parts

P112 | Mimaki printer spare parts

P115 | Mutoh printer spare parts

P118 | Encad printer spare parts

P121 | Hp printer spare parts

P122 | Canon printer spare parts

P124 | Seiko / Liyu / GongZheng printer spare parts

P126 | Infiniti printer spare parts

P129 | Myjet / Galaxy printer spare parts

P130 | Wit - color printer spare parts

P131 | Flora printer spare parts

### **P133 | Accessional Device for Printer**

### **P137 | Materials and Inks**

P137 | Indoor inkjet media

P137 | PVC inkjet media

P139 | glossy RC water - proof media

P142 | ECO wall paper

P143 | inkjet media in pigment ink

P145 | indoor inkjet printing media

P148 | PET inkjet film

P149 | matte water - proof media

P151 | inkjet canvas

### **P153 | Outdoor inkjet media**

P153 | self adhesive vinyl film (vehicle wraps)

P156 | PVC flex banner

P161 | coated mesh fabric

P162 | one way vision

P164 | PVC tarpaulin

### **P166 | ECO inkjet media**

### **P169 | Magnetic printing material**

### **P171 | Laminating film**

P171 | cold laminating film

P176 | hot laminating film

### **P177 | Reflective sheeting**

### **P180 | Grommet & vinyl banner glue**

### **P184 | Inkjet ink**

P184 | water - based ink & cartridge (dye & pigment)

P186 | solvent - based ink

P187 | ECO ink & cartridge

### **P188 | Sublimation**

P188 | sublimation fabric

P189 | sublimation paper

P190 | heat transfer vinyl

P194 | sublimation blanks

P197 | badge & buttons

P198 | sublimation ink

## 02 / ENGRAVING PRODUCTS

### **P200 | Engraving & Cutting Machine**

P200 | Laser engraver

P213 | Laser cutter

P222 | Laser marker

P224 | CNC engraver & router

P239 | CNC cutter

### **P244 | Vinyl Cutter**

### **P249 | Engraving Auxiliary Products**

### **P257 | Channel Letter Making Machine and Material**

### **P261 | Acrylic Finishing Machine**

### **P265 | Engraving Supplies**

P265 | Engraving bits

P267 | Cutting self - adhesive vinyl & squeegees

P268 | Glue & advertising nail

# CONTENTS

- P269 | Cutting mat & craft knives
- P271 | Advertising protectional ruler
- P272 | Engraving Board & Sheet

## 03 / POP & EXHIBIT DISPLAYS

- P274 | Portable Banner Display**
  - P274 | ECO bamboo banner display
  - P275 | Display booth stand system
  - P277 | Roll up banner stand
  - P280 | Pop up display
  - P283 | X and L banner stand
  - P285 | Flag banner stand
  - P287 | Backpack banner
- P288 | Fabric Tension Display**
- P291 | Poster Display Stand**
- P292 | Brochure Stand**
- P293 | Portable Trade Show Counters**
- P296 | Sign Holder**
- P298 | Store Display Rack**
- P299 | Display Light Box**
  - P299 | Slim LED light box
  - P303 | Acrylic crystal light box
  - P305 | Magic light box
  - P307 | Rotating & scrolling light box
- P311 | LCD Advertising Player**

## 04 / LED PRODUCTS

- P314 | LED Innovative Products**
- P319 | LED Full Color Screen**
- P323 | LED Scrolling Sign**
- P326 | LED Modules**
- P329 | Decorative Light**
  - P329 | Decorative light
  - P333 | Rope light string
  - P335 | LED strip

## 05 / PHOTO STUDIO

- P338 | Book Binding Machine**
  - P338 | Photo book station
  - P339 | Perfect binding machine
  - P341 | Book hard cover maker

- P343 | Electric guillotine paper cutter
- P344 | Book Binding Auxiliary Device**
  - P344 | Book pressing machine
  - P345 | Joint pressing machine
  - P346 | Paper creasing machine
- P348 | Photo & Card Cutter**
- P352 | Laminator**
- P354 | Photo Studio Supplies**
  - P354 | Photo paper
  - P355 | Photo laminating film

## 06 / ADVERTISING BOARDS

- P358 | ABS Double Color Sheet**
- P359 | Acrylic Board & Sheet**
- P363 | PVC Foam Board**

## 07 / ADVERTISING SIGN MAKING

- P366 | Vinyl Banner Custom Printing**
- P367 | Custom - made Digital Sublimation Printing**
- P369 | Custom - made Electroluminescent Display**
- P371 | Custom - made POP / POS**
- P374 | Custom - made Sign Letters**
- P377 | Custom - made Inflatable Model**

## Quick Index

- P001 | Shopping Online**
- P004 | Contents**
- P006 | Oration of CEO**
- P007 | About This Brochure**
- P008 | Buyers Said**
- P378 | Questions & Answers**
- P396 | Purchase Order**
- P397 | Brief Introduction of Inkjet Printing Industries Association of PEIAC**
- P398 | Registration and Free Subscription of This Brochure for Customers**



## Oration of CEO

**Dear friends,**

Welcome to [www.Sign-in-China.com](http://www.Sign-in-China.com)

The advertising production and signage industry is a new and rapid developing industry, which brings us many opportunities and has set a prosperous future for the friends in this circle. I sincerely expect Sign-in-China.com to create more development opportunities for you.

As nowadays we are living in the era of internet, [www.Sign-in-China.com](http://www.Sign-in-China.com) is professionally devoted to contribute more conveniences, safety, improved experiences, and competitive prices through the internet. We are honored that Sign-in-China.com is one of the leading players in the e - commerce of signage industry. At present, with about 6 years of website efforts, our products have been sold to more than 180 countries and areas, even including the remote country Bhutan, in the southeast of Himalayas, and some island nations in the ocean.

We have over 10,000 kinds of products covering the entire industry of advertising and signage. Besides of those made in China, there are also some good quality products sourced from Japan, South Korea, Italy, etc. and every kind of product is strictly approved for you by our senior product managers.

At the same time, Sign-in-China.com has strategically set up oversea offices, respectively, in the USA, Russia, Brazil, France, Mexico, Thailand as well as Vietnam. Additionally, we have also established stock warehouse in each of these countries in order to provide more prompt and considerate services to the local customers. Our staff around the world shall be 7 x 24 hours available to serve you.

Our existing achievement is attributed to our core team who has more than 15 years experience in advertising & signage manufacturing and international selling. It is also ascribed to our rigorous management and quality control on more than 1000 suppliers.

In vista of the signage future, with the prosperous internet support and Chinese quality signage products, it will build up a bright prospect to the international market. As for you, you should seize this chance!

We faithfully expect Sign-in-China.com to be your first option of buying Chinese advertising and signage products.

If you wish to become our local market agent or distributor, you are always welcome to contact us and formulate our cooperation details together.

With our sincere thanks to you all!

A handwritten signature in black ink, appearing to be '刘亚航' (Liu Yahang), the name of the CEO.

**Yanhang Liu, CEO**

Email: [lyh@ChinaSigns.cn](mailto:lyh@ChinaSigns.cn)



# About This Brochure

It's a great honor that the Buyers Guide - Total Product Collection List, 2013 - 2014 published by Sign-in-China.com (Beijing ChinaSigns Information Co., Ltd) has become your considerate assistant in procurement. This brochure, edited and published by Sign-in-China.com and **Inkjet Printing Association of China, Inkjet Printing Sub - association of PEIAC** (Printing & Printing Equipment Industries Association of China), has been widely distributed on expos of signage and advertising exhibitions both in China and other countries.

## Classification

**When you get a Buyers Guide in hand, you will find it is a well - categorized book.**

Wherein you can find seven categories of products which are Inkjet Printing Products, Engraving Products, POP & Exhibit Display, LED Products, Photo Studio Products, Plastic Board & Sheet, Advertising Sign Marking as well as consumables of each category.

For reading convenience of this brochure, we arranged seven full - colored pages, each respectively, indicating the total subclass of a complete product category.

## Price

All the prices in this brochure are FOB stepped price which meet different purchase requirements that the more quantity you buy, the lower price you enjoy.

In addition to the prices, we also entitle certain discounts or favorable promotions to the members who registered on [www.Sign-in-China.com](http://www.Sign-in-China.com) or filled up the membership application form on back of this brochure.

The price in the Buyers Guide may float subject to foreign exchange, promotion activities, product upgrading and so on.

Hence, all the information in this brochure shall be construed by [www.Sign-in-China.com](http://www.Sign-in-China.com) and confirmed by our sale staff or upon the final commercial invoice.

## Copyright

Any part of the information, any copy or reprint of this Buyers Guide, while without authorization, is forbidden to quote, duplicate or re - issue.

The product photos in this Buyers Guide are for reference of sample use, should there be any similarity appeared, it is purely coincidental. For any doubt or confusion, please contact us.

## Product Symbols



**High quality products:** Product with high quality.



**Recommended products:** High cost performance and hot products in this brochure and on our website.



**Economical products:** Practical products with more favorable price and cost reduced.



**New products:** Newly released products or the enhanced or upgraded products.



**Certification:** The products with CE.

Subject to your requirement, we can either provide you a paper brochure or E - catalogue, hence please request us.

In reason of time limit from composing, we feel sorry for any mistake herein and we highly appreciate your valuable correction and suggestion so that, subsequently in newer version, we will definitely make further efforts in improvement and perfection.

**You may contact us by any of the following ways when you intend to purchase any of our products:**

- Fill up the Purchase Order at the end of this brochure and fax it to + 86 - 10 - 51118313.
- Call us on + 86 - 10 - 63705868 - 607
- Visit [www.Sign-in-China.com](http://www.Sign-in-China.com) and select your interested products then order directly online.
- Send us email to: [info@Sign-in-China.com](mailto:info@Sign-in-China.com)
- **Skype:** SigninChina02
- **Facebook:** <http://www.facebook.com/pages/sign-in-china/120161784747890>
- **Twitter:** <http://twitter.com/signsglobal>

# Buyers Said .....

Thank you for your order!

Agradecemos-lhe pelo pedido!

Gracias por la compra!

Спасибо за Ваш заказ!

ご購入いただきありがとうございます！



ขอขอบคุณที่สั่งของ

مكبلط يلع اركش!

Merci d'avoir commander!

## Juriy from Russia

**Product: Flower Printer**

I am an owner of flower chain store in Russia and I need flower printer to start new business. I try to contact Sign-in-China.com online and they are so fast and kind to help us choose suitable printer. We are very satisfied of their service. I will do more business with you guys.



## Mikulas Bocz from Slovakia

**Product: 3D Smart Mug Heat Transfer Machine**

I own sign - making business and resell good products in Italy and Slovakia. Here from sign-in-china, I see the possibility of getting multiple machines and materials with favorable shipment from China. I will do more business with you guys.

## Muhammed from the USA

**Product: Spare Parts**

We meet at the Guangzhou show, and they supplied great service, not only helped me with the business, but also some other issues. I am considering being the reseller of their company; their products and service are so good. Hope we can meet some more cooperation.



## Pedro Villaseñor from Mexico

**Product: Roll - to - Roll Large Format heat transfer machine 1700 (oil - warming machine)**

I walked around the factory and saw how the machine works. The printing effect is impressive and roll to roll can expedite process. I purchased the Roll - to - Roll Large Format Heat Transfer Machine. It's amazing!

## Mohammed from Sri Lanka

**Product: Printing Machines**

I'm Mohammed from Sri Lanka. This is the third time I attend the Sign Expo in Shanghai, I know almost all large format print factories in China, and I also know the quality of them. Sign-in-China is a very good and professional company. They can offer you the good quality product with a very good price. Make me to earn a lot of profits.

Most of all, they have very good service, saves me a lot of troubles during the after - sales part. I will definitely buy more!



## Tim Sheng from USA

**Product: Printing Machines**

I'm Tim from New York, I've attended a lot of Sign Expo all over the world every year. I met sign-in-china at SGIA for 2 times in United States. This is the third time I come across with them again, at the Shanghai EXPO in July, 2013.

I've been purchasing from them 2 years ago since LA SIGN show. They have very good products, and very good services. What's more, they have been in this field for more than 10 years. A group of very professional guys.

Love you. I am very satisfied.

Hope we can keep this good business relationship and enlarge both of our market.

## Mr. Cornelius Tan from Singapore

**Product: 10ft S - shape Fabric Tension Display Wall with Double - side Printing**

We received display wall. Everything is in order. I like the way you handled the situation last week and your great service. You can be sure that I am happy to introduce your company if anyone asks where we get our display banner.



## Sereme Seydou from Burkina Faso

**Product: Compatible Roland EAGLE eco solvent ink (No ICC Profile Needed / 3 - Year Outdoor Durability)**

My name is Sereme Seydou from Burkina Faso, I own one big printing company in Ouagadougou. I used to bought eco solvent inks from France, the price was real expensive, but last month a friend of mine recommended me to buy it from sign-in-china.com, they offered me \$48 for 150 liters, which is real cheaper now, and the quality is real good also, they guarantee me 36 months outdoor durability which is perfect for me. I visited the headquarter of sign-in-china.com in Beijing, those guys there were very nice to me, they helped me a lot, I can buy all kinds of ADS products online now.

## Sytha from Cambodia

**Product: Mug heat transfer machine**

Yeah! I am so glad with the heat transfer machine, and now I can make mugs all by myself. Look at the mug in my hand! Sign-in-China helped me know a lot about international shipping, how to run a mug sublimation business and even how to find a supplier of mugs. Thank you so much!



# Buyers Said .....



## Ricardo Alfaro from Panama

**Product: Vehicle Wrap**

My name is Ricardo Alfaro from Panama, I am one of the top quality printing companies in Panama. I have faced the troubles of high price of the 3M vehicle wrap. But Sign-in-china.com solved the problem. They can provide the same quality of 3M vinyl without 3M label which was produced by the 3M appointed factory. I have visited the headquarter of Sign-in-China.com, nice office and nice work! We can get any advertising products from [www.Sign-in-China.com](http://www.Sign-in-China.com)!



## Mr. Mirfat Bogucanin from Bosnia and Herzegovina

**Products: Inkjet printer's ink**

The poster with brilliant colors on the building behind me was printed by your solvent ink. I am very satisfied with your ink and services. I am confident that my company will establish mutual and solid business relationship with Sign-in-China.com and develop more opportunities in future.

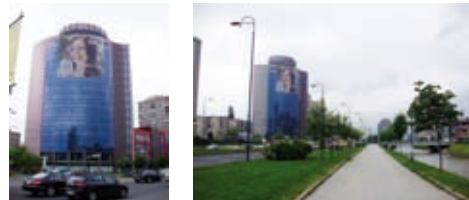

## I Paresh T. Bhana from CEO CTR Graphics

**Products: ABS double color sheets**

I would like to express our sincere thanks and appreciation for all the work, Flora (a sales staff of Sign-in-China.com) has been of had put in our source for products. Flora has been of outstanding assistance and always very helpful. She has even gone out of her way. Included below is a photo of the samples she sent to us of ABS sheets for laser Engraving.



## Joseph from Malta

**Products: Laser engraver / cnc router**

We operate in Malta with more than 50 years experience in signage. Around October 2008 I managed to make contact with Sign-in-China.com and from then onwards we built a good relation.

I managed to obtained equipment and material relating to signage. Sign-in-China.com offers good quality equipment and material. They also offer five stars after sales service. They get back to you within minutes after you launch a query or you may get in contact with them via Live Messenger (MSN). I highly recommend this company a worth visiting [www.Sign-in-China.com](http://www.Sign-in-China.com).



## Brazil

**Products: Vinyl cutter CPM-RS-1360C**

The vinyl cutter is working well, and I am happy with it. It is helpful when cut vinyl labels; it can cut the printed ones. Super!



## Mr. Khalid from France

**Products: Sign Letters**

I had purchased LED lighting letters sample of our company Logo from Sign-in-China.com before. And our clients are very interested in these products. I am sure your product will bring us more business chance further!

## Petar from Bosnia-Herzegovina

**Products: A3 flatbed printer**

Hi Robin (Customer service manager), my dear friend thanks for your birthday present. Since we had purchased first flatbed printer from Sign-in-China.com 2 years ago, we had kept purchased 6pcs flatbed printers and I do trust this printer will bringing us more business chance further.



## From Uzbekistan

**Products: Printer spare parts**

This is a group photo of Sign-in-China.com with me in Uzbekistan. I bought about a total 5000 total printer spare parts from them in September, 2011. Really professional team and excellent service. What's more, all their parts are quality confirmed; you never need to worry the quality. This is really important both to me and my customer. Will buy more, more and more...

## John Hanmer from the USA

**Products: Display banners**

The teardrop banners look great, we put them up and the county government told us to take them down until we buy a permit. Whether the government is here or there they don't make life easy for small business. I will recommend you to all my friends in business. It is really a good experience to have business with you.



## Loannis Arvantis from Greece

**Products: Xaar / Spectra printhead**

We met Sign-in-China.com at the Shanghai exhibition. It's a good memory to do business with them. We bought some print heads there; Sign-in-China.com told us we could check the heads one by one. After checking we are sure that everyone is original and new. That's very important for us and the price is good, too. We believe we'll cooperate with Sign-in-China.com for a long time.

## Mr. Sachin Shroff from India

**Products: PVC foam sheets**

We have cooperated with Sign-in-China.com since 2009. They do not only supply very high quality PVC foam board to us, but also supply very professional and patient service. Every time when I come to China for visiting Sign-in-China.com, they show me the highest quality products. They will calculate the best price after I am satisfied for the PVC foam sheets. I am really very happy between our cooperation. We are sure we will continue our business cooperation with Sign-in-China.com in the future.



# Buyers Said .....

## Sam from Zimbabwe

**Product: Eco solvent ink**

I'm Sam from Zimbabwe.

I've been cooperating with Sign-in-China.com since the beginning of 2012.

I must say Sign-in-China.com is a really good and professional company; they always support me with good quality inks. Also, they have other qualified spare parts & machines.

If you ever have any problem, you can contact them freely, and they always do the best service. Do not worry about parts problem, change with them freely.



## Dave from the USA

**Products: Roll up display**

Hey, look at this roll up. I haven't imaged this price can get such a wonderful roll up stand with printing.

It is printed on a durable material and the carry bag is cool. It is a good experience and I am glad to pay more attention on [www.Sign-in-China.com](http://www.Sign-in-China.com) and find more opportunity to have one by one good cooperation. I am sure of it.

## Mr. Saeed Safai from America

**Products: Acrylic polishing machines**

I received your gift for the New Year yesterday, thank you very much. It was really nice of you I wish you joy. The acrylic polishing machines I purchased from you on 16th June are one of our companies best sellers now. All my customers are very satisfied with them. I will order more in the coming 2012.



## Jain from India

**Products: Laser marking machine**



I am from India, I bought a laser marking machine from Sign-in-China.com in September 2008, this machine works well on my hologram, when I went to China in Oct. 2008, they gave me very nice free training, their engineer is very patient and well qualified. Whenever I meet problem in operation of the machine, they always help me at first time. I really appreciate their kindness.

## Mr. Tommy from Denmark

**Products: Acrylic logo**

The acrylic logo I purchased for my shop is perfect and I like it very much. Thank you, Sign-in-China.com. I will introduce this company to friends, and I hope to have more cooperation with you in the near future.



# 01 INKJET PRINTING PRODUCTS

All the Equipments Have a **2 Year** Warranty



## P014 | Large Format Printer

## P025 | 3D Printer & Accessories & Supplies

## P027 | Heat Transfer Machine

- P027 | Large format heat transfer machine
- P028 | 3D vacuum heat press machine
- P030 | Combo heat press machine
- P032 | T - shirt heat transfer machine
- P043 | Mug & plate heat transfer machine
- P048 | Badge making machine
- P050 | Heat press starter kit
- P052 | Heat press accessories & badge mold

## P053 | Flatbed Printer & Supplies

## P059 | Flag Making Machine

## P061 | Laminator & Finishing Equipments

- P061 | Wide format roll laminator
- P074 | Liquid laminator
- P076 | Vinyl banner slitter & welder
- P082 | Slot puncher and paper trimmer
- P085 | Grommet machine

## P089 | Flower & Nail Art Printer

## P092 | Inkjet Printhead

## P097 | Printer Spare Parts

- P097 | Epson printer spare parts
- P107 | Roland printer spare parts
- P112 | Mimaki printer spare parts
- P115 | Mutoh printer spare parts
- P118 | Encad printer spare parts
- P121 | Hp printer spare parts
- P122 | Canon printer spare parts
- P124 | Seiko / Liyu / GongZheng printer spare parts
- P126 | Infiniti printer spare parts
- P129 | Myjet / Galaxy printer spare parts
- P130 | Wit - color printer spare parts
- P131 | Flora printer spare parts

## P133 | Accessional Device for Printer

## P137 | Materials and Inks

- P137 | Indoor inkjet media
  - P137 | PVC inkjet media
  - P139 | glossy RC water - proof media
  - P142 | ECO wall paper
  - P143 | inkjet media in pigment ink
  - P145 | indoor inkjet printing media
  - P148 | PET inkjet film
  - P149 | matte water - proof media
  - P151 | inkjet canvas
- P153 | Outdoor inkjet media
  - P153 | self adhesive vinyl film (vehicle wraps)
  - P156 | PVC flex banner
  - P161 | coated mesh fabric
  - P162 | one way vision
  - P164 | PVC tarpaulin
- P166 | ECO inkjet media
- P169 | Magnetic printing material
- P171 | Laminating film
  - P171 | cold laminating film
  - P176 | hot laminating film
- P177 | Reflective sheeting
- P180 | Grommet & vinyl banner glue
- P184 | Inkjet ink
  - P184 | water - based ink & cartridge (dye & pigment)
  - P186 | solvent - based ink
  - P187 | ECO ink & cartridge
- P188 | Sublimation
  - P188 | sublimation fabric
  - P189 | sublimation paper
  - P190 | heat transfer vinyl
  - P194 | sublimation blanks
  - P197 | badge & buttons
  - P198 | sublimation ink

## > Large Format Printer

### FBP-UV Series Flatbed Printer (Konica 512 - 14PL)

● **Design:** The true flatbed design uses a unique strong sectional vacuum system in six different zones, or a set of built - in wheels that can be lifted up and down to fix media to the table, while printing, to provide accurate registration. The heavy - duty chassis ensures durability, and enables to hold heavy materials up to 100mm thick.

● The bed is equipped with media locating pins, for accurate media replacement, to obtain the most accurate results when printing the same image repeatedly.

● **Ink:** A negative pressure ink supply system controls traditional colors, white ink and varnish separately. Correct purging is achieved with state - of the - art printhead technology that uses a built - in temperature sensor and a heater. This guarantees fluid and continuous prints with no auto cleaning while printing, so you save a lot of UV ink each year.

● **Ink Colors:** Basic 4 colors, 6 colors, white and varnish options are available. For white color applications you can choose from: overlay white, underlay white, fill white, spot white and under color white. Clear top coating varnish as a separate application is used to increase outdoor durable life, avoid scratch and add or reduce gloss.

● Unique bi - directional printing option makes it easy to switch from white underlay to white overlay option, saving time while the x - beam returns.

● **Printheads:** This printer uses Konica Minolta KM512 - 14pl printheads and can achieve a maximum resolution of 1440 dpi.

● An integrated printhead capping device system, while the printer is in stand - by mode, protects the nozzles from light and dust automatically, to extend printhead durability and reduce ink usage.

● **RIP Software:** Caldera, Photoprint, or Manager V9.22 are the RIP software options for this printer, you can achieve vivid and sharp printed images by using the "feather" option of these RIP software.



FBP-2512-4C-UV



FBP-3020-8C-UV

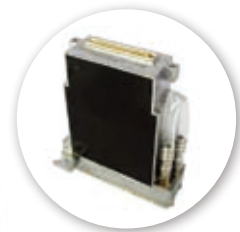

Konica Minolta  
printhead KM512

### ▼ Samples



Glass



Ipad shell



Cabinet



Wooden door



Wooden floor



Wooden floor





## > Large Format Printer

### ▼ Specifications



Model (Table Type / Size)	FBP-2512-UV		FBP-3020-UV	
P. H. Qty. / Color	1p. h. / c	2p. h. / c	3p.h. / c	4p.h. / c
Speed	Precision	8m <sup>2</sup> / h	14m <sup>2</sup> / h	22m <sup>2</sup> / h
	Production	11m <sup>2</sup> / h	18m <sup>2</sup> / h	27m <sup>2</sup> / h
	Draft	16m <sup>2</sup> / h	25m <sup>2</sup> / h	33m <sup>2</sup> / h
Print Area	2500mm x 1250mm (98" x 49")		3050mm x 2050mm (120" x 81")	
Media Thickness	100mm (3.9")		100mm (3.9")	
P. H. Type	KM-512-MH			
P. H. Qty.	4, 5, 6, 7, 8, 10, 12			
Color Mode	C, M, Y, K, LC, LM, White + Varnish			
Rip Software	Photoprint 6.0 Or Caldera			
Environment Requirements	Dust free room. Temperature range from 20°C - 28°C. Humidity: 40% - 60%			
Power Supply	Single Phase AC220V, 50Hz / 60Hz, 3KW			
Machine Dimension	4430mm x 2000mm x 1230mm (174" x 79" x 48")		4220mm x 4230mm x 1550mm (166" x 166" x 61")	
Machine Weight	3968.3lb / 1800kg		4850.2lb / 2200kg	

### ▼ Price List

Model	Printing width	Printhead No.	Color Model	Price
FBP-2512-4C-UV	47" (1200mm)	4	C, M, Y, K	≤ \$43,549
FBP-2512-5C-UV	47" (1200mm)	5	C, M, Y, K, W	≤ \$46,704
FBP-2512-6C-UV	47" (1200mm)	6	C, M, Y, K, W, V	≤ \$49,860
FBP-2512-8C-UV	47" (1200mm)	8	C, M, Y, K, LC, LM, W, V	≤ \$54,909
FBP-3020-8C-UV	79" (2000mm)	16	2 x (C, M, Y, K, LC, LM, W, V)	≤ \$85,300
FBP-3020-5C-UV	79" (2000mm)	15	3 x (C, M, Y, K, W)	≤ \$85,300
FBP-3020-4C-UV	79" (2000mm)	16	4 x (C, M, Y, K)	≤ \$89,000

## 3.3M (130") SD Series Synchro Double Sided Solvent Printer (Konica512 - 42PL)

- This series printer is especially suitable for professional light box makers. As productive facilities of light box media operators and banners manufacturers, it greatly enhances the release quality of its terminal projects and corporate brand visibility.
- Synchro double sided printing, multi - function.
- Integrated media loading device, efficient IR dryer, automatic print heads cleaning units capping device, media take - up and feeding devices with clutch and air pressure rollers can ensure reliable printing output.
- There is no special requirement on the quality and length of the media.



### ▼ Main Configuration Information

**Maximum Printing Width:** 126" (3200mm)

**Maximum Media Width:** 130" (3300mm)

**Printhead:** Konica512 - 42pl (8 - 24printheads)

**Ink Type:** Solvent ink

**Media Type:** Paper, advertising banner, PVC, mesh fabrics, vinyl and carpet, etc.

**Colors:** C, M, Y, K or C, M, Y, K, LC, LM

**RIP Software:** Photoprint, Ultraprint, Caldera

**Maximum Resolution:** 720dpi

**Interface:** USB 2.0 / Hi USB

### ▼ Specifications



Model	LFIP-SD-3308	LFIP-SD-3316
	LFIP-SD-3312	LFIP-SD-3324
Printhead	KM-512-42PL	
No. of Printhead	8pcs, 12pcs, 16pcs, 24pcs	
Single-sided Print	23m <sup>2</sup> / h	46m <sup>2</sup> / h
Double-sided Print	22m <sup>2</sup> / h	36m <sup>2</sup> / h
Price	8 printheads: ≤ \$63,550	16 printheads: ≤ \$79,550
	12 printheads: ≤ \$72,550	24 printheads: ≤ \$93,550

> Large Format Printer

### FBP-UV Series Flatbed and Roll Printer

▼ Main Configuration Information

**Maximum Printing Width:** 98.4" (2500mm)

**Maximum Media Width:** 98.4" (2500mm)

**Printhead:** Konica 512 - 14pl (4 - 12 printheads)

**Ink Type:** UV ink

**Media Type:** Rigid medias such as glass, ceramic tile, aluminum sheet, wooden board, billboard, acryl sheet, KT board, plexiglass, foamboard and corrugated paper, flexible materials like wall paper, glistening film, canvas, carpet, leather, paper, PVC, ect.

**Colors:** C, M, Y, K, LC, LM + White + Varnish

**RIP Software:** Caldera or Photoprint

**Max. Resolution:** 1440DPI

**Interface:** USB 2.0 / Hi USB



Konica print head KM512MH

- Unique Y axis two ways printing, which can print both to forward or backward. Saving the time of X beam return to initial point during underlay and overlay of white ink and varnish.
- 8-levels UV energy are adjustable for different materials to avoid thermal deformation.
- Separately negative pressure ink supply system for color and white ink. Printheads having temperature sensor and heater which can help fluent and continuous printing without head cleaning to save inks.
- Basic 4 colors, 6 colors, white and varnish configurations are optional. White options of underlay white, overlay white, fill white, spot white and under color white can achieve full white applications.
- Location pins mounted on table to load regular or irregular materials in right place, which ensures same print starting point in X and Y direction for batch jobs.

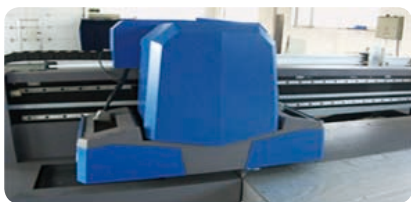

The new design of the cover cap



THK linear guide



Panasonic servo motor

▼ Price List

Model	Printhead No.	Color	Price
FBP-2505R-5C	5	CMYK W	≤ \$60,145
FBP-2506R-6C	6	CMYK W V	≤ \$63,623
FBP-2508R-8C	8	CMYK LC LM W V	≤ \$68,579
FBP-2512R-6C	12	2 (CMYK W V)	≤ \$82,491

▼ Samples



Glass deco



Wooden floor

▼ Specifications

Model	FBP-UV Series Flatbed and Roll Printer				
Head Type	KM-512-MH				
Maximum Resolution	1440DPI				
Media Fixing Method	Flatbed		Roll to Roll		
Heads No.	4, 5, 6, 7	8, 12	4, 6	8, 12	
Speed	Draft	16m <sup>2</sup> / h	25m <sup>2</sup> / h	15m <sup>2</sup> / h	23m <sup>2</sup> / h
	Production	11m <sup>2</sup> / h	18m <sup>2</sup> / h	10m <sup>2</sup> / h	16m <sup>2</sup> / h
	Hi-Precision	8m <sup>2</sup> / h	14m <sup>2</sup> / h	7m <sup>2</sup> / h	12m <sup>2</sup> / h
Maximum Media Thickness	100mm (3.9")				
Maximum Printing Width	2500mm (98.4")		2030mm (80")		
Machine Dimension	4650mm x 2150mm x 1550mm (183" x 84.6" x 61")				
Machine Weight	3300lb / 1500kg				



## &gt; Large Format Printer

**3.2M Xaar128 Series Economical Solvent Large Format Printer****▼ Main Configuration Information****Maximum Printing Width:** 126" (3200mm)**Maximum Media Width:** 130" (3300mm)**Printhead:** Xaar128 / 40W printhead, 8 / 12 / 16 heads inside**Ink Type:** Solvent ink**Media Type:** Banner, Adhesive Vinyl, PVC flex banner, Backlit Film, Flex media within 5mm (0.2") thickness.**Colors:** C, M, Y, K**RIP Software:** Photoprint, Ultraprint**Maximum Resolution:** 740dpi**Interface:** High speed USB boards

HIWIN guide rail



Xaar 128 printhead



Economic

- This style is very economical.
- Use the Hiwin straight line guide rail.
- Removable leg, decreasing the freight for the clients.
- Use the leadshine digital motor driver.
- Automatic flash print printhead automatic flash works while interval printing.

**▼ Price List**

Model	LFIP-MJT-LA3212XR12		
Printhead Type	Xaar128 / 40W printhead		
Maximum Printing Width	126" (3200mm)		
	8pcs	12pcs	16pcs
Speed	180 x 370dpi, 42m <sup>2</sup> / h	180 x 370dpi, 63m <sup>2</sup> / h	180 x 370dpi, 84m <sup>2</sup> / h
	240 x 555dpi, 31m <sup>2</sup> / h	240 x 555dpi, 47m <sup>2</sup> / h	240 x 555dpi, 63m <sup>2</sup> / h
	240 x 740dpi, 21m <sup>2</sup> / h	240 x 740dpi, 31m <sup>2</sup> / h	240 x 740dpi, 41m <sup>2</sup> / h
Power Requirement	AC220V, 50Hz / 60Hz		
Operation Environment	Temperature: 20°C - 25°C; Humidity: 40% - 70% RH		
Machine Dimension / Weight	180" x 31" x 51" (4580mm x 780mm x 1300mm) / 1433.0lb (650kg)		
<b>Price</b>	<b>≤ \$8,400</b>	<b>≤ \$9,980</b>	<b>≤ \$12,360</b>



Leadshine digital servo driver



Ultra width printing platform

**3.2M (126") WD Series Solvent Printer (Xaar600 - 60PL)**

- Use Xaar 600 particle Printhead, increase the print speed up to 60%.
- Famous brand linear guide rails with double - slider
- High - power and double AC servo system
- Pall capsule - type filter from USA



Print platform lighting



Capsule - type filter



Ink temperature system

**▼ Main Configuration Information****Maximum Printing Width:** 126" (3200mm)**Maximum Media Width:** 130" (3300mm)**Printhead:** Xaar 600 Particle Printhead**Ink Type:** Solvent inks**Media Type:** Banner, Adhesive Vinyl, PVC Self - Adhesive, Backlit Film, Flex media within 5mm (0.2") thickness.**Colors:** C, M, Y, K**RIP Software:** Photoprint, Ultraprint**Max. Resolution:** 720DPI**Interface:** High speed USB board**▼ Price List**

Model	LFIP-MJT-WD3216XR60	
Printhead Type	Xaar600 particle printhead	
Maximum Printing Width	126" (3200mm)	
Printing Mode	4 Colors with 16 printheads	
Speed	High speed	240 x 360dpi, 120m <sup>2</sup> / h, 2 pass
	Middle speed	240 x 540dpi, 90m <sup>2</sup> / h, 3 pass
	Low speed	360 x 720dpi, 50m <sup>2</sup> / h, 4 pass
Power Requirement	AC220V, 50Hz / 60Hz	
Operation Environment	Temperature: 20°C - 25°C; Humidity: 40% - 70% RH	
Machine Dimension / Weight	187" x 37" x 53" (4760mm x 950mm x 1350mm) / 2094.4lb (950kg)	
<b>Price</b>	<b>≤ \$27,986</b>	

> Large Format Printer

**CALCA1800 ECO - Solvent Printer**



- Improved print head cleaning and maintenance system
- Independently controlled pre, platen & post heaters
- Hi - USB 2.0 printing interface
- Windows 7 32 / 64bit system
- Shipped with Standard Feeding system & Photo PRINT RIP software

▼ Main Configuration Information

**Maximum Printing Width:** 1800mm (70.8")

**Maximum Media Width:** 1880mm (74")

**Printhead:** EPSON DX7 Printhead

**Ink Type:** ECO - solvent ink

**Media Type:** Self - adhesive vinyl, vehicle body sticker, cold laminating film, banner, paper, film, etc.

**Colors:** C, M, Y, K

**RIP Software:** Photoprint

**Max. Resolution:** 1440dpi

**Interface:** HI - USB2.0



THK linear mute rail



High power servo motor



Aluminium alloy feeding sheet



Piezo electric inkjet print head



Pressure roller

▼ Price List

Model		LFIP-RNS-1800	
Printhead		EPSON DX7 Printhead	
No. of Printheads		One	TWO
Maximum Printing Width		1800mm (70.8")	
Maximum Media Width		1880mm (74")	
Print speed	4 Pass	18m <sup>2</sup> / hr	29m <sup>2</sup> / hr
	6 Pass	14m <sup>2</sup> / hr	23m <sup>2</sup> / hr
	8Pass	10m <sup>2</sup> / hr	18m <sup>2</sup> / hr
	16 Pass	8m <sup>2</sup> / hr	13m <sup>2</sup> / hr
Ink Type	Color	4 Colors (CMYK) / ECO - Solvent ink	
Printhead Height		2 - 3mm adjustable	
Heating System		Pre, Platen & Post heaters	
Auto Printhead Cleaning		Automatic flush. Anti - clogged Flash Function & moisturizing system	
Data transmission connector		HI - USB2.0	
Power		AC 220 - 240 V 10%, 3.9 A, 50 / 60Hz	
Machine Dimension / Weight		2715mm x 650mm x 1245mm (107" x 26" x 49") / 361.5lb (164kg)	
<b>Price</b>		≤ \$7,105	≤ \$8,190



▼ Samples



Light box



Vinyl



One - way vision



Pop - up display

## &gt; Large Format Printer

**3.2M (126") Konica Economic High Precision Printer (KM512 - 14PL head)****▼ Main Configuration Information****Maximum Printing Width:** 3200mm (126")**Maximum Media Width:** 3300mm (130")**Printhead:** KM512 - 14PL**Ink Type:** ECO - Solvent inks**Media Type:** Banner, Adhesive Vinyl, PVC Self - Adhesive, Backlit Film, Flex media within 5mm thickness.**Colors:** C, M, Y, K**RIP Software:** Photoprint**Max. Resolution:** 720dpi**Interface:** High speed USB2.0

- Powerful functions units, ensure machine output stably and effectively all the time
- Konica Minolta certified and strongly recommended control system, developed printhead's best core performance while the boards are rarely fault.
- Multiple created and improved motor gears and fixing devices ensure for precise printing and long stable working.

**▼ Price List**

Model	LFIP-TMS-P5KM14	
Printhead	KM512 - 14PL Printhead	
No. of Printheads	4pcs	8pcs
Maximum Printing Width	3200mm (126")	
Maximum Media Width	3300mm (130")	
Print speed	360 x 360dpi 2pass	26m <sup>2</sup> / hr
	360 x 1080dpi 3pass	17m <sup>2</sup> / hr
	720 x 1440dpi 4pass	11.3m <sup>2</sup> / hr
	720 x 1080dpi 6pass	7.7m <sup>2</sup> / hr
Ink Type	Color 4 Colors (CMYK) / ECO - Solvent ink	
Auto Media Feeding System	Equipped (Maximum Media Weight 120kg)	
Pre - heating & Drying System	Equipped (Drying System Optional)	
Auto Cleaning System	Positive Pressure Cleaning Anti - clogged Flash Function & Capping System	
Print Interface	HI - USB2.0	
Power	AC 220 - 240 V 10%, 3.9 A, 50 / 60Hz	
Machine Dimension / Weight	4360mm x 790mm x 1170mm (172 " x 31" x 46 ") / 925.9 lb (420kg)	
<b>Price</b>	≤ \$12,456	≤ \$17,460

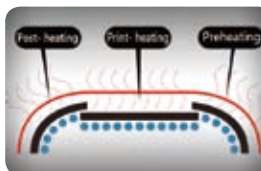
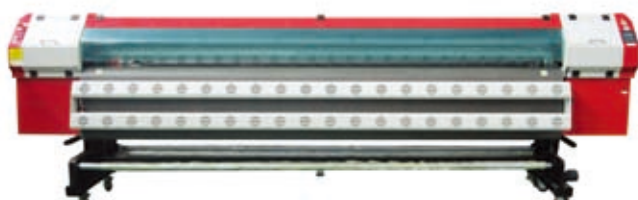
**▼ Samples****3.2M (126") LB Series Solvent Printer (Konica512 - 42PL)**

- Japan Konica 512 42PL Printhead.
- Printhead heating, can enable the printer to print in low temperature.
- Two rows dry-fans, can make the printed picture dry up quickly.
- Large print platform design.
- Ink temperature system.

**▼ Price List**

Model	LFIP-MJT-LB3208KM42	
Printhead Type	KM 512/42PL head (8 printheads)	
Printing Media Width	126" (3200mm)	
Speed	High speed	180 x 720dpi: 70m <sup>2</sup> / h 2pass
	Mid speed	240 x 540dpi: 58m <sup>2</sup> / h 3pass
	Low speed	360 x 1440dpi: 45m <sup>2</sup> / h 4pass
Heating System	Front heater + Bed heater + Rear heater + Printhead heater	
Power Requirement	AC220V	
Operation Environment	Temperature: 20°C - 25°C. Humidity: 40% - 70%RH	
Machine Dimension / Weight	4760mm x 950mm x 1570mm (187" x 37" x 62") / 1433lb (650kg)	
<b>Price</b>	≤ \$18,545	

**▼ Main Configuration Information****Max. Printing Width:** 126" (3200mm)**Max. Feeding Width:** 130" (3300mm)**Printhead:** KM512 / 42PL head**Ink Type:** Solvent ink**Media Type:** Banner, Adhesive Vinyl, PVC flex banner, Backlit Film, Flex media within 5mm thickness.**Colors:** C, M, Y, K, 4 Colors with 8 printheads**RIP Software:** Photoprint, Maintop, Ultraprint**Maximum Resolution:** 720dpi**Interface:** High speed USB board

> Large Format Printer

**36" / 50" ECO - Solvent Printer & Cutter Digital Wide Format Inkjet Machine**



▼ Main Configuration Information

**Maximum Printing Width:** 890mm (35") / 1200mm (47.2")

**Maximum Media Width:** 914mm (36") / 1270mm (50")

**Printhead:** EPSON DX5 Printhead

**Ink Type:** ECO - solvent ink

**Media Type:** Self - adhesive vinyl, vehicle body sticker, cold laminating film, banner, paper, film, heat transfer paper, etc.

**Colors:** C, M, Y, K

**RIP Software:** FlexiSIGN - PRO, SAI

**Maximum Resolution:** 1440dpi

**Interface:** HI - USB2.0



THK linear mute rail



Piezo electric inkjet print head

- Adopt two directions high power servo motors, ensure high precision of printing and cutting, very stable.
- Adopt well - know brand THK linear mute rail, less noise.
- High quality prints with a maximum resolution of up to 1440 dpi.
- Combined with inkjet printing, cutting, digital die - cutting functions, one machine three usages.
- Equipped ECO - solvent ink printing application solutions.
- Equipped with independent heating system.



Aluminium alloy feeding sheet



Pressure roller



Color LED control panel buttons



High cutting force



High power servo motor



▼ Price List

Model	LFIP-RNS-CP36	LFIP-RNS-CP50
Printhead	EPSON DX5 Printhead	
No. of Printheads	One	One
Maximum Printing Width	890mm (35")	1200mm (47.2")
Maximum Media Width	914mm (36")	1270mm (50")
Print speed	High Speed	8m <sup>2</sup> / hr
	Middle Speed	6m <sup>2</sup> / hr
	Standard Speed	4m <sup>2</sup> / hr
Ink Type	4 Colors (CMYK) / ECO - Solvent ink	
	Color	
Cutting speed	10 to 300 mm / s	
Cutting force	30 to 800 GF	
Repeat accuracy / Alignment accuracy	± 0.1mm or less / ± 0.5mm or less	
Power	AC 220 - 240V 10%, 3.9 A, 50 / 60Hz	
Machine Dimension / Weight	1830mm x 660mm x 1230mm	2130mm x 660mm x 1230mm
	(72" x 26" x 48 ") / 330.6 lb (150kg)	(84" x 26" x 48 ") / 418.8lb (190kg)
<b>Price</b>	<b>≤ \$8,473</b>	<b>≤ \$9,086</b>

▼ Samples



> Large Format Printer

## CALCA3208 Spectra Polaris Printhead Wide Format Printer

### ▼ Main Configuration Information

**Maximum Printing Width:** 3200mm (126")  
**Maximum Media Width:** 3300mm (130")  
**Printhead:** Spectra Polaris 512 - 35pl  
**Ink Type:** Solvent inks  
**Media Type:** Banner, Adhesive Vinyl, PVC Self - Adhesive, Backlit Film, Flex media within 5mm thickness.  
**Colors:** C, M, Y, K  
**RIP Software:** Photoprint  
**Max. Resolution:** 1200dpi  
**Interface:** High speed USB boards



- High Intension Integrated Steel Frame Structure
- Industrial Automatic Cloth Feeding and Collecting System
- Negative Pressure System
- Large Capacity Optical Fiber System
- Air Absorbing System on the Platform
- Printhead Moisturizing Device
- Automatic Micro Jetting Function
- Cloth Lifting Device



Spectra polars PQ-512 printhead



High precision linear guide rail



Negative pressure system



Ink supply and nozzle cleaning system



Industrial automatic cloth feeding and collecting system



Ultra width printing platform

### ▼ Price List



Model	LFIP-CACS-3208PQ	
Print Technique	Spectra PQ 512/35pl Piezo electric Print head	
Resolution	1200dpi	
Maximum Media Width	3300mm (130")	
Maximum Printing Width	3200mm (126")	
Output	Draft	185sqm / hr
	Stand	125sqm / hr
	High	92sqm / hr
Ink Type/Color	Solvent or ECO - solvent base: C, M, Y, K	
Ink Inspection	Auto / Manual ink supply, low ink detector	
Power	AC 220V, 50Hz / 60Hz	
Working Environment	Temperature: 20°C - 28°C Humidity: 40% - 70%	
Machine Dimension / Weight	4830mm x 960mm x 1380mm (190" x 37" x 54") / 1322.7lb (600kg)	
Price	≤ \$30,578	

### ▼ Samples

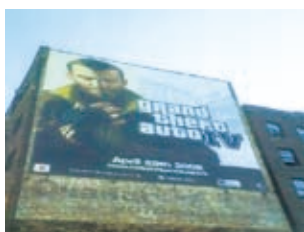

> Large Format Printer

**CALCA3200 Supper Format ECO - Solvent Printer**



▼ Main Configuration Information

**Maximum Printing Width:** 3200mm (126")

**Maximum Media Width:** 3300mm (130")

**Printhead:** EPSON DX7 Printhead

**Ink Type:** ECO - Solvent inks

**Media Type:** Vinyl, Flex, Polyester, Back - lit Film, Window Film, etc.

**Colors:** C, M, Y, K

**RIP Software:** Photoprint

**Maximum Resolution:** 1440dpi

**Interface:** High speed USB board



Pinch roller & vacuum panel



Double drying fans



Dual media feeding system



Ink cartridge

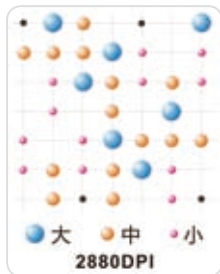

- Adopt the classic control system from Professional system integrate company, practiced for many years to ensure the stable performance in line with the military standard.
- Stable AC servo motor - provide the high precision, stability, smoothness of movement to ensure you with a high precision of printing and cloth feeding.
- Adopt the famous brand of high speed and quite guide rail to ensure the high precision, low noise, abrasive resistance as well as the stability of the carrier.
- Imported raster with the performance of high precision to ensure the position of each ink drop.
- Adopt the 1.25G bi - directional optic transmission to eliminate the interference of telecommunication, as well as to ensure a high capacity and high speed data transmission.
- Adopts high precision steel structure, the horizontal accuracy is  $\pm 0.05\text{mm}$  to ensure the printing quality and stability even in high speed.
- Adopt the high strength aluminum magnesium alloy crossbeam, with higher strength higher precision and smaller weight.

▼ Specifications



Model	LFIP-RNS-3200
Print Technique	2pcs EPSON DX7 Printheads
Resolution	1440dpi
Maximum Media Width	3300mm (130")
Maximum Printing Width	3200mm (126")
Output	3 pass
	4 pass
	6 pass
Ink Type / Color	ECO - solvent Ink: C, M, Y, K
Heating System	Adjustable 2 pre - heating heaters, adjustable post - heating and cooling fan
Power	AC 220V, 50Hz / 60Hz
Working Environment	Temperature: 20°C - 28°C. Humidity: 40% - 70%
Machine Dimension / Weight	4456mm x 958mm x 1280mm (175" x 38" x 50") / 771.6lb (350kg)
<b>Price</b>	<b>≤ \$12,575</b>

▼ Samples



Light box



Vinyl

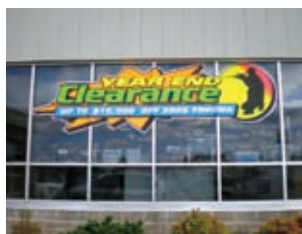

One - way vision



Pop - up display



## &gt; Large Format Printer

**3.2m CJ4000II Series Economical Solvent Large Format Printer (Seiko510 - 35pl)****▼ Main Configuration Information****Maximum Printing Width:** 3200mm (126")**Maximum Media Width:** 3220mm (126.8")**Printhead:** Seiko SPT510 / 35PL Printhead**Ink Type:** Solvent ink**Media Type:** Banner, Adhesive Vinyl, PVC Self-Adhesive, Backlit Film, Flex media within 5mm thickness.**Colors:** C, M, Y, K**RIP Software:** Photoprint, Maintop**Maximum Resolution:** 720dpi**Interface:** High speed USB boards

- DC24V low voltage heating function ensures smooth printing in low temperature.
- 400W high - power AC servo control system means long life, fast response, and high accuracy and ensures equipment's work stability.
- Cleaning includes withdrawing cleaning and monochromatic pressure cleaning. A key refilling function makes printhead's maintenance easy and convenient.
- With super wide printing platform, the machine can load more heads and easy upgraded.
- Independent moisturizing ink panel is used for avoiding the string of ink. moisturizing handle limit switch is good for avoiding wrong operation which may damage printhead
- Detecting printhead's temperature and adjusting voltage automatically improves the printhead's stability.
- Three stops constant temperature heating system, flash drying, and better ink absorption, higher precision and powerful working efficiency.



Printhead

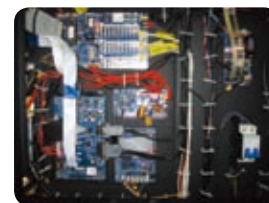

Electrical control system



Capping system



Ink system

**▼ Specifications**

Model	CJ4306II	CJ4308II	CJ4304II	
Printhead	SPT510 / 35PL			
No. of Printheads	6	8	4	
Printhead Sequency	1 x 6	2 x 4	1 x 4	
Maximum Printing Width	126" (3200mm)			
Maximum Media Width	126.8" (3220mm)			
Print speed	High Speed	240 x 540, 3pass, 56m <sup>2</sup> / hr	240 x 720, 2pass, 82m <sup>2</sup> / hr	180 x 540, 3pass, 50m <sup>2</sup> / hr
	Middle Speed	240 x 720, 4pass, 41m <sup>2</sup> / hr	180 x 1080, 3pass, 68m <sup>2</sup> / hr	240 x 540, 3pass, 36m <sup>2</sup> / hr
	Standard Speed	360 x 540, 3pass, 37m <sup>2</sup> / hr	180 x 1440, 4pass, 50m <sup>2</sup> / hr	180 x 720, 4pass, 32m <sup>2</sup> / hr
Ink Type	Color	K, C, M, Y, LC, LM	K, C, M, Y	K, C, M, Y
Cleaning Method	Single color positive flush (with pressure protection), auto flushing & head moistening			
Printer info	Voltage	AC220V, 50Hz / 60Hz (AC110V, 50Hz / 60Hz is optional)		
	Power	Printing: 500W Platform heating: Front heating 1000W / Middle heating 1000WW / Back heating 1000W		
	Working Environment	Normal temperature: 22 ~ 28°C Humidity: 40% ~ 70% RH		
	Machine Dimension / Weight	4840mm x 1000mm x 1340mm (191" x 39" x 53") / 20.5 ± 0.6lb (520 ± 15kg)		
<b>Price</b>	<b>≤ \$16,462</b>	<b>≤ \$18,895</b>	<b>≤ \$13,800</b>	

> Large Format Printer

**3.2m (126") CJ7308 Industrial Large Format Printer (Seiko1020 / 35pl)**

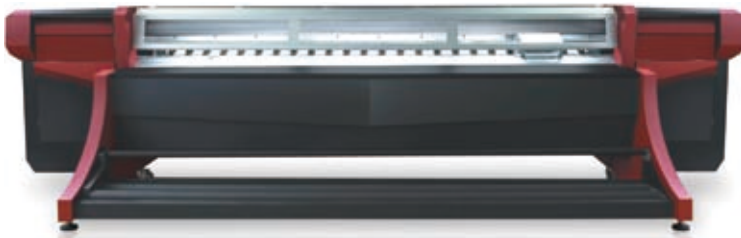

▼ Specifications

Model		LFIP-JH-CJ7308
Printhead Type		SPT1020 / 35PL
Number of Printheads		8
Printhead Combination		2 x 4
Print Width		127" (3220mm)
Media Width		129" (3280mm)
Print Speed	Print Mode	Speed
	High Speed Mode	180 x 720, 2pass, 220m <sup>2</sup> / hr
	Standard Mode	240 x 720, 2pass, 180m <sup>2</sup> / hr
	High Quality Mode	240 x 1080, 3pass, 121m <sup>2</sup> / hr
Ink Type		Color K, C, M, Y
Auto Feeding System		Infrared - detecting, feed & take - up system with memory function
Heating System		three stage heating system (Preheating, Print - heating, post - heating)
Print Head Heating		Low - voltage consistent - temperature head-heating (DC24V)
Carriage Height		2 ~ 5mm Distance to platform, adjustable
Printing Assistant System		One key positive pressure ink injecting, adjustable media absorbing force, anti - warp media press, subtank heating, lighting for print form and cleaning, drying fan, spitting ink clean collecting , emergency stop. integrated heating and take - up system (optional)
Printer Info	Voltage	AC 220V, 50 / 60Hz
	Power	Print system: 500W; Heating system (Post-, 1000W, print-, 1500W, pre-, 1000W)
	Working Environment	Temperature: 22°C ~ 28°C; Humidity: 40% ~ 70%RH
	Machine Dimension and Weight	5150mm x 850mm x 1400mm (203" x 33" x 55.1") / 1433lb (650kg)
<b>Price</b>		<b>≤ \$27,031</b>

▼ Main Configuration Information

**Maximum Printing Width:** 3200mm (126")

**Maximum Media Width:** 3280mm (129.13")

**Printhead:** Seiko SPT1020 / 35PL Printhead

**Ink Type:** Solvent inks

**Media Type:** Banner, Adhesive Vinyl, PVC Self - Adhesive, Backlit Film, Flex media within 5mm (0.2") thickness.

**Colors:** C, M, Y, K

**RIP Software:** Photoprint, Maintop

**Max. Resolution:** 720dpi

**Interface:** High speed USB boards



Waste ink recovery system

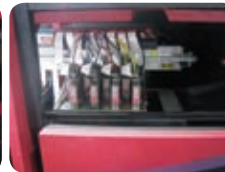

8pcs seiko spt1020-35pl printhead



Double servo drive system



New paper pinch roller



Fiber board system

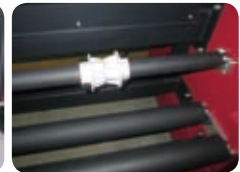

Feeding media system

- High speed printing**  
This printer adopts 8pcs SEIKO SPT1020 - 35PL heads, multiunit 2pass with print speed 220m<sup>2</sup> / h.
- Dual servo system**  
Horizontal and vertical parts are using servo drivers and motors, paper feeding more accurate and fast printing. The other equipment adapts stepper driver and motor.
- Industrial drying cloth retractable system**  
Enhanced drying system can quickly dry the screen, three linkage of the cloth loose system make and material difficult to wrinkle. The heavy retractable cloth system can receive and wind heavier material.
- The new board design, fiber optic data transmission**  
CJ7308 uses new board; the data bus adopts optical fiber to transmit. Strong anti - jamming capability can guarantee the stability of the data transmit, and avoid crashes, messy code or other abnormalities.
- Low cost for printhead upgrade**  
SPT1020 printhead costs lower than that of Spectra PQ512 / 35PL, which will help the users save cost for upgrading or replacing the printhead.

▼ Samples

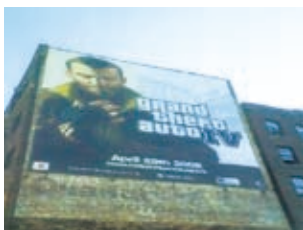

## > 3D Printer & Accessories & Supplies

### Economical ABS & PLA Dual - extruder Desktop 3D Printer

This Desktop 3D Printer is simple, easy to operate. You can follow our user manual to DIY. We are professional supplier, and professional Technical Support is also supplied.

#### ▼ Specifications

Model	3DP-JH3D-B
Print Technology	Fused Filament Fabrication
Extruder Model	Dual - extruder
Printing Precision	0.1mm - 0.2mm
Nozzle Caliber	0.4mm
Nozzle Flow Velocity	24cc / t
Theoretical Positioning Precision	Z axis 0.0025mm, XY axis 0.011mm
Build Size	225mm x 145mm x 150mm
Layer Thickness	0.1 - 0.5mm (Adjustable)
Motion Shaft Speed	40mm / s
Printing Material	ABS & PLA 1.75mm
Material Diameter	1.75mm - 1.8mm
Material Colors	White, Yellow, Red, Black, Blue, Green
Max Control Temp	260 °C
Recommend Nozzle Temp	230 °C
Heating Plate Temp	120 °C
Print Format	STL
Link	SD Card / Computer
Operation Interface	Chinese / English
Workstation Compatibility	Windows XP, Vista, Win 7 & Mac OX
Power Requirements	AC 110 - 230V, 300W
Machine Dimension / Weight	320mm x 467mm x 381mm (12.5" x 18" x 15") / 28.6lb (13kg)
<b>Price</b>	<b>≤ \$1,107</b>

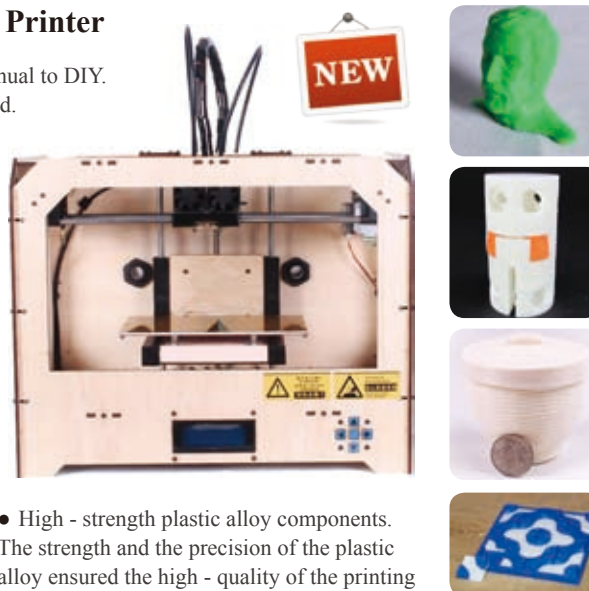

- High - strength plastic alloy components. The strength and the precision of the plastic alloy ensured the high - quality of the printing product.
- The new upgrades printhead with better feeding filament structure. The printhead is the most important part of a 3D printer and it works more stable and smoother when printing.
- New Upgraded Circuit Board, the new self-designed power circuit board. It works more stably and can effectively avoid being overheated.
- Dual - printhead, 2 - color printing, it could be used to print multi - colored puzzles.

### Economical ABS & PLA Single - extruder Desktop 3D Printer

This Desktop 3D Printer is simple, easy to operate. You can follow our user manual to DIY. We are professional supplier, and professional Technical Support is also supplied.



#### ▼ Specifications

Model	3DP-JH3D-A
Print Technology	Fused Filament Fabrication
Extruder Model	Single - extruder
Printing Precision	0.1 - 0.2mm
Nozzle Caliber	0.4mm
Nozzle Flow Velocity	24cc / t
Theoretical Positioning Precision	Z axis 0.0025mm, XY axis 0.011mm
Build Size	225mm x 145mm x 150mm
Layer Thickness	0.1 - 0.5mm (Adjustable)
Motion Shaft Speed	40mm / s
Printing Material	ABS & PLA 1.75mm
Material Diameter	1.75 - 1.8mm
Material Colors	White, Yellow, Red, Black, Blue, Green
Max Control Temp	260 °C
Recommend Nozzle Temp	230 °C
Heating Plate Temp	120 °C
Print Format	STL
Link	SD Card / Computer
Operation Interface	Chinese / English
Workstation Compatibility	Windows XP, Vista, Win 7 & Mac OX
Power Requirements	AC 110 - 230V, 300W
Machine Dimension / Weight	320mm x 467mm x 381mm (12.5" x 18.3" x 15") / 28.6lb (13kg)
<b>Price</b>	<b>≤ \$958</b>

- High - strength plastic alloy components. The strength and the precision of the plastic alloy ensured the high - quality of the printing product.
- The new upgrades printhead with better feeding filament structure. The printhead is the most important part of a 3D printer and it works more stable and smoother when printing.
- New Upgraded Circuit Board, the new self - designed power circuit board. It works more stably and can effectively avoid being overheated.
- Exclusive filament feed system, work automatically without people.

## &gt; 3D Printer &amp; Accessories &amp; Supplies

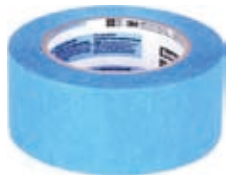
**3DP-JHPJ-001: 3M BLUE Tape for Desktop 3D Printer**

**Model:** 50mm x 50m  
**Color:** Blue  
 Used for all Nozzle Diameter 0.4mm Desktop 3D printer  
**Price:** ≤ \$24.5 / set

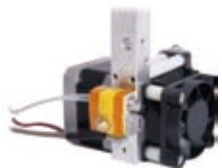
**3DP-JHPJ-002: Single - extruder for Desktop 3D Printer**

**Printing Precision:** 0.1 - 0.2mm  
**Nozzle Caliber:** 0.4mm  
**Recommend Nozzle Temp:** 230°C  
 Used for Our ABS & PLA Single - extruder Desktop 3D printer  
**Price:** ≤ \$156.83 / set

**3DP-JHPJ-003: Dual - extruder for Desktop 3D Printer**

**Printing Precision:** 0.1 - 0.2mm  
**Nozzle Caliber:** 0.4mm  
**Recommend Nozzle Temp:** 230°C  
 Used for Our ABS & PLA Dual - extruder Desktop 3D printer  
**Price:** ≤ \$303 / set

**3DP-JHPJ-004: XY Axis Motor for Desktop 3D Printer**

**Voltage:** DC 4.83V  
**Current:** 0.84A  
**Moment:** 0.28N.m Min.  
 Used for Our ABS & PLA Single / Dual - extruder Desktop 3D printer  
**Price:** ≤ \$34.31 / set

**3DP-JHPJ-005: Z Axis Motor for Desktop 3D Printer**

**Voltage:** DC 12V  
**Current:** 0.4A  
**Moment:** 0.24N.m Min.  
 Used for our ABS & PLA Single / Dual - extruder Desktop 3D printer  
**Price:** ≤ \$83.31 / set

**3DP-JHPJ-006: 0.4mm Nozzle for Desktop 3D Printer**

**Color:** Golden  
**Nozzle Caliber:** 0.4mm  
 Used for Our ABS & PLA Single / Dual - extruder Desktop 3D printer  
**Price:** ≤ \$13.72 / pc

**3DP-PLA Series PLA Filament for Desktop 3D Printer**

**Color:** Blue, Black, Green, Yellow  
**Diameter:** 1.75mm  
**Material:** PLA  
**Filament Spool Diameter:** 162mm  
 Used for all Nozzle Diameter 0.4mm Desktop 3D printer  
**Price:** ≤ \$24.5 / roll

**3DP-PLA-003: Transparent PLA Filament for Desktop 3D Printer**

**Color:** Transparent  
**Diameter:** 1.75mm  
**Material:** PLA  
**Filament Spool Diameter:** 162mm  
 Used for all Nozzle Diameter 0.4mm Desktop 3D printer  
**Price:** ≤ \$27.44 / roll

**3DP-ABS Series ABS Filament for Desktop 3D Printer**

**Color:** Red, Blue, Black, Green, Yellow, White  
**Diameter:** 1.75mm  
**Material:** ABS  
**Filament Spool Diameter:** 162mm  
 Used for all Nozzle Diameter 0.4mm Desktop 3D printer  
**Price:** ≤ \$24.5 / roll

**3DP-ABS-005: Transparent ABS Filament for Desktop 3D Printer**

**Color:** Transparent  
**Diameter:** 1.75mm  
**Material:** ABS  
**Filament Spool Diameter:** 162mm  
 Used for all Nozzle Diameter 0.4mm Desktop 3D printer  
**Price:** ≤ \$35.29 / roll



## > Heat Transfer Machine > Large format heat transfer machine

### Large Format Flatbed Heat Transfer Press Machine

The heat press machine has a hydraulic large format system, suitable for sportswear, cloths, snowboard, textile fabrics, metal plate, seat pad and foot pad etc. This machine has a large working table that can transfer large images to a variety of materials. Strong color penetration on fabrics without print gaps.



- Digital temperature control to obtain a uniform temperature.
- High accuracy electronic time control.
- Upper electronic heat plate make heat evenly.
- Strong color penetration on fabrics without print gaps, vivid and uniform colors, this machine can transfer to flexible fabrics such as swimsuits and more.

#### ▼ Specifications

Model	Working Size	Temperature	Voltage	Power	Packing Size	Machine Weight	Price
CS-HTM-PDD-1012	1200mm x 1000mm (47" x 39")	0 - 399°C	380V, 50Hz	14.4KW	1800mm x 1400mm x 1850mm (71" x 55" x 73")	950kg	≤ \$12,189
CS-HTM-PDD-1015	1500mm x 1000mm (59" x 39")	0 - 399°C	380V, 50Hz	18KW	2100mm x 1400mm x 1850mm (83" x 55" x 73")	1100kg	≤ \$13,778
CS-HTM-PDD-1217	1700mm x 1200mm (67" x 47")	0 - 399°C	380V, 50Hz	20KW	2350mm x 1700mm x 1950mm (92" x 67" x 77")	1800kg	≤ \$19,417

#### ▼ Samples



### Large Format Oil - heating Roll - to - Roll Heat Transfer Machine



The machine is a new type of heat transfer equipment, it fully represents the advantage of the speed and good effect in transfer printing. It adopts the oil heating mode to control the temperature, achieving speed in warming and good effect in the heat preservation, as well as improving the productivity.

It is suitable for printing on whole roll of fabric and can be separated with the barrel.

The latest separation style of digital thermal transfer printing machine (With oil - warming blanket) is a major breakthrough of the digital thermal transfer printing machine.



- Roll to Roll transfer, full - auto machine (Automatic take - up roll for both printed images and back paper by one person).
- Low noise and stable speed.
- Peripheral temperature rising is fast, heating is more even and good effect in the heat preservation.
- No cooling machine is needed and the blanket can be separated with the barrel.
- The tension of the blanket can be adjusted more easily. Automatic blanket off, automatic lifting off backing paper and Automatic rolling picture.
- Convenient operation with power - failure protection function.
- Applicable for printing on whole roll of fabric, seat pad, foot pad, back pad, sleeping bag, handicraft fan, umbrella and hanging painting, and all kinds of fabric can be also ironed, pressed and folded.

#### ▼ Specifications

Model	Working Size	Temperature	Voltage	Power	Machine Dimension	Machine Weight	Price
CS-HTM-FLRTR-1700	1700mm (67")	0 - 240°C	380V, 50Hz	20KW	2480mm x 780mm x 1440mm (98" x 31" x 57")	1150kg	≤ \$9,790

> Heat Transfer Machine > 3D vacuum heat press machine

### HTM-AHP-3D: Multifunction All in One 3D Vacuum Heat Press Machine

The 3D vacuum heat transfer machine is multifunctional for both flat items and curved items, such as T - shirt, pillowcase, tile, mouse pad, glass, crystal, plate, mug, iPhone cover, iPad cover, etc.

- 3D vacuum press is based on the newest sublimation technology.
- High efficient, it can imprint 12 mugs at one time.
- Safety, dual temperature control on software and hardware separately and it'll power off within 15 minutes without any operation.
- High intelligent, you can only close the cover and no need to press any button when working.
- It's made of special aluminum and iron material that is high flame - retardant and thermal-insulated.
- It uses hot rollers with vacuum sucking moulding to transfer items of three-dimensional surface one time with perfect imprint effect.
- It is designed with asperities dots on the surface of working table to enlarge the heating area, and the more dots, the more wonderful transferring image it transfers.



▼ Including:

- One set of 3D vacuum heat transfer machine
- One piece vacuum film
- Two pieces 11OZ mug clamber
- One piece 15OZ mug clamber
- One set mold of Iphone4 / Iphone4S
- One pieces 3in1 11OZ mug clamber (for free)
- One bag Sublimation Paper (for free)

▼ Specifications

Model	HTM-AHP-3D
Transferring Area	300mm x 420mm x 110mm (11.8" x 16.5" x 4.3")
Inspiratory Time	18S
Vacuum Pressure	negative 0.1KPA
Voltage	AC 110V, 60HZ / AC 220V, 50HZ
Power	2800W
Time Range	0 - 999S
Temperature Range	0 - 250°C
Dimesion	470mm x 590mm x 290mm (18.5" x 23.2" x 11.4")
<b>Price</b>	<b>≤ \$585</b>



<p><b>Ipadmin / Iphone 4 4S cover</b></p>			<p><b>Mouse Pad</b></p>		
<p><b>Metal plate</b></p>	<p><b>Plastic item</b></p>	<p><b>Table Cloth</b></p>	<p><b>Wooden Item</b></p>	<p><b>Pillowcase</b></p>	<p><b>Slippers</b></p>

## HTM-AHP-3D-S: 3D Vacuum Sublimation Heat Press Machine for Mugs

### Including Free Gift Package Valued \$40

The 3D vacuum heat transfer machine is multifunctional for both flat items and curved items, such as T - shirt, pillowcase, tile, mouse pad, glass, crystal, plate, mug, etc.



- 3D vacuum press is based on the newest sublimation technology.
- High efficient, it can imprint 12 mugs at one time.
- Safety, dual temperature control on software and hardware separately and it'll power off within 15 minutes without any operation.
- High intelligent, you can only close the cover and no need to press any button when working.
- It's made of special aluminum and iron material that is high flame - retardant and thermal-insulated.
- It uses hot rollers with vacuum sucking moulding to transfer items of three-dimensional surface one time with perfect imprint effect.
- It is designed with asperities dots on the surface of working table to enlarge the heating area, and the more dots, the more wonderful transferring image it transfers.

Many mugs transferring



### ▼ Specifications

Model	HTM-AHP-3D-S
Transferring Area	300mm x 420mm x 110mm (11.8" x 16.5" x 4.3")
Inspiratory Time	18S
Vacuum Pressure	negative 0.1KPA
Voltage	AC 110V, 60HZ / AC 220V, 50HZ
Power	2800W
Time Range	0 - 999S
Temperature Range	0 - 250°C
Dimesion	470mm x 590mm x 290mm (18.5" x 23.2" x 11.4")
<b>Price</b>	<b>≤ \$566</b>

### ▼ Including:

- One set of 3D vacuum heat transfer machine
- One piece vacuum film
- Two pieces 11OZ mug clamper
- One gift package for transferring (for free)

#### Sublimation Rock Slate



#### T-shirt



#### Tiles



#### Ceramic plate



#### Crystal



#### Mugs



## &gt; Heat Transfer Machine &gt; Combo heat press machine

**HTM-MLF-5in1: 5 in 1 Combo Heat Press Machine**

It can transfer any image as you like to T - shirt, mug, cap, plate, metal sheet, etc. Just one machine can be used as four machines.



- Combo type, it could transfer images to T - shirt, mug, plate, cap and so on
- Digital controlling ensures the high precision and sensitivity
- The changing among spare parts is available when necessary
- Heating coil and heating panel are integrated, safe and durable
- Adopting advanced technology and good material for better effect
- Swing - away design and more even pressure guarantees you perfect printing

**▼ Specifications**

Model	HTM-MLF-5in1	
Size (T-shirt Panel)	5.9" x 7.8" (15cm x 20cm)	11" x 15" (28cm x 38cm)
Size (Mug)	2.9" - 3.3" (7.5cm - 8.5cm)	2.9" - 3.3" (7.5cm - 8.5cm)
Size (Cap)	3.2" x 5.9" (8cm x 15cm)	3.2" x 5.9" (8cm x 15cm)
Size (Plate)	4.7" / 5.9" (12cm / 15cm)	4.7" / 5.9" (12cm / 15cm)
Voltage	AC 110V, 60HZ / AC 220V, 50HZ	AC 110V, 60HZ / AC 220V, 50HZ
Power	450W - 1000W	450W - 1200W
Time Range	0 - 999S	0 - 999S
Temperature Range	0 - 399°C	0 - 399°C
<b>Price</b>	<b>≤ \$302</b>	<b>≤ \$358</b>

**HTM-MLF-8in1: 8 in 1 Combo Heat Press Machine**

It can transfer any image as you like to T - shirt, mug, cap, plate, metal sheet, etc. Just one machine can be used as four machines.

- Combo type, it could transfer images to T - shirt, mug, plate, cap and so on
- Widely used, add two conical mug heating mat for cone mugs
- Digital control ensures the high precision and sensitivity
- The changing among the spare parts is available when necessary
- High precise automatic digital temperature indicator

**▼ Specifications**

Model	HTM-MLF-8in1		
Size (T - shirt Panel)	5.9" x 7.8" (15cm x 20cm)	11" x 15" (28cm x 38cm)	15" x 15" (38cm x 38cm)
Size (Mug)	12oz / 17oz (for conical mug) 2.2" - 2.8" / 2.9" - 3.3" (5.5cm - 7.0cm / 7.5cm - 8.5cm) (for cylindrical mug)		
Size (Cap)	3.2" x 5.9" (8cm x 15cm)		
Size (Plate)	4.7" / 5.9" (12cm / 15cm)		
Voltage	AC 110V, 60HZ / AC 220V, 50HZ		
Power	450W - 1200W		
Time Range	0 - 999S		
Temperature Range	0 - 399°C		
<b>Price</b>	<b>≤ \$342</b>	<b>≤ \$488</b>	<b>≤ \$507</b>

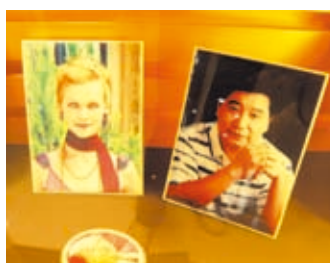
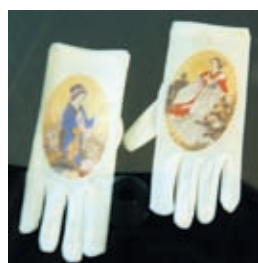
**▼ Samples**



## > Heat Transfer Machine > Combo heat press machine

### HTM-300DTH: 6 in 1 Combo Digital Heat Press Machine

6 in 1 Heat press machine is multifunctional type that is transferring images to T - shirts, caps, mugs, plates, etc.

- Manual type, fine workmanship.
- Multifunctional, you can use it widely.
- Digital control by the SCM program ensures the high precision and sensitivity.
- Count automatically and it will alarm when the temperature goes higher than the one you set.
- The changing among the spare parts is available when necessary.
- Adopting advanced technology and good material for better effect.

#### ▼ Specifications

Model	HTM-300DTH
Size (T - shirt Panel)	12.0" x 15.0" (30cm x 38cm)
Size (Mug)	2.87" - 3.15" (7.3cm - 8.0cm)
Size (Cap)	5.8" x 3.1" (14.8cm x 8cm)
Size (Plate)	4.5" / 5.9" (11.5cm / 15cm)
Voltage	AC 110V, 60HZ / AC 220V, 50HZ
Power	1200W
Time Range	0 - 999S
Temperature Range	0 - 399°C
<b>Price</b>	<b>≤ \$509</b>



### HTM-CP3815: 2 in 1 Combo Heat Press Machine

This 2 in 1 Heat press machine is multifunctional type that is used to transfer images to T - shirts, caps, other small flat item, etc.

- Combo type, for transferring images on caps, tiles, metal sheets, etc.
- Swing-away design, easy for prepare work.
- Adjustable knob to ensure the suitable pressure.
- Integrated time and temperature controller, and it'll warn when time is up.

#### ▼ Specifications

Model	HTM-CP3815
Size (T - shirt Panel)	4.7" x 4.7" (12cm x 12cm)
Size (Cap)	3.1" x 5.5" (8cm x 14cm)
Voltage	AC 110V, 60HZ / AC 220V, 50HZ
Power	550W
Time Range	0 - 999S
Temperature Range	0 - 380°C
<b>Price</b>	<b>≤ \$207</b>



#### ▼ Samples

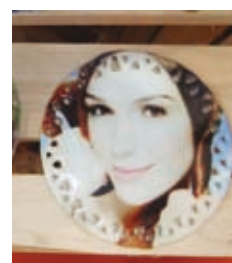

> Heat Transfer Machine > T - shirt heat transfer machine

### HTM-3804D: Auto Open Heat Press Machine with Slide Out Style

Widely used for transferring T - shirt, bag, pant and others made of textile, knitting, non - woven, chemical fiber or cotton materials, and also for metal sheet, decorate flat surface, etc.

- Magnetic Auto Open Feature
- Over - center pressure adjustment
- Digital time and temperature controller
- Teflon coated upper heat platen
- Slide Out Press Table for Convenient Preparation



▼ Specifications

Model	HTM-HP3804D	
Working Size	15" x 15" (38cm x 38cm)	16" x 20" (40cm x 50cm)
Voltage	AC 110V, 60Hz / AC 220V, 50Hz	AC 110V, 60Hz / AC 220V, 50Hz
Power	1400W	1800W
Time Range	0 - 999S	0 - 999S
Temperature Range	0 - 399°C	0 - 399°C
<b>Price</b>	<b>≤ \$299</b>	<b>≤ \$309</b>

### HTM-3804C: Auto Open Heat Press Machine

Widely used for transferring T - shirt, bag, pillowcase and others made of textile, knitting, non - woven, chemical fiber or cotton materials, and also for metal sheet, adornment with flat surface, etc.

- Magnetic Auto Open Feature
- Over - center pressure adjustment
- Digital time and temperature controller
- Teflon coated upper heat platen



Magnet



Pressure adjustment button



Handle



Time & temperature controller

▼ Specifications

Model	HTM-3804C	
Working Size	15" x 15" (38cm x 38cm)	16" x 20" (40cm x 50cm)
Voltage	AC 110V, 60Hz / AC 220V, 50Hz	AC 110V, 60Hz / AC 220V, 50Hz
Power	1400W	1800W
Time Range	0 - 999S	0 - 999S
Temperature Range	0 - 399°C	0 - 399°C
<b>Price</b>	<b>≤ \$370</b>	<b>≤ \$423</b>

▼ Samples



## &gt; Heat Transfer Machine &gt; T - shirt heat transfer machine

**HTM-HP3804: 15" x 15" Manual Heat Press Machine with Four Spring Legs**

This heat press machine is widely used for transferring T - shirt, bag, pillowcase and others which are made of textile, knitting, non - woven, chemical fiber or cotton materials, and metal sheet, adornment, etc.



- 15" x 15" Teflon coated heat platen
- Spring system added for even pressure
- Real - time display of temperature condition with automatic alarm
- Over - center pressure adjustment for easily to adjust the pressure

**▼ Specifications**

Model	HTM-HP3804
Working Size	15" x 15" (38cm x 38cm)
Voltage	AC 110V, 60Hz / AC 220V, 50Hz
Power	1400W
Time Range	0 - 999S
Temperature Range	0 - 399°C
<b>Price</b>	<b>≤ \$226</b>

**HTM-HP3804B: Upgraded European Manual Heat Press Machine**

Widely used for transferring T - shirt, bag, pillowcase and others made of textile, knitting, non - woven, chemical fiber or cotton materials, and also for metal sheet, adornment with plane surface, etc.

- High density of heating board
- Digital control panel
- Spring - Added device and a thicker heating board guarantee a perfect print
- Real - time display of temperature condition with an automatic alarm
- Easy to operate and adjust pressure
- Improved structure provides even pressure when pressing on materials

**▼ Specifications**

Model	HTM-HP3804B	
Working Size	15" x 15" (38cm x 38cm)	16" x 20" (40cm x 50cm)
Voltage	AC 110V, 60Hz / AC 220V, 50Hz	AC 110V, 60Hz / AC 220V, 50Hz
Power	1400W	1800W
Time Range	0 - 999S	0 - 999S
Temperature Range	0 - 399°C	0 - 399°C
<b>Price</b>	<b>≤ \$275</b>	<b>≤ \$330</b>

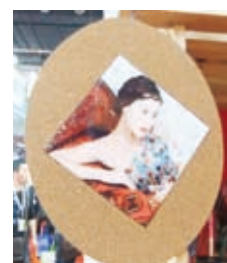
**▼ Samples**

## &gt; Heat Transfer Machine &gt; T - shirt heat transfer machine

**HTM-3805: Swing - away Manual Heat Press Machine with High Pressure Style**

You can transfer any image to T - shirt, pillowcase, table cloth, metal sheet, etc.



- Swing - away type
- Digital time and temperature controller
- Evenly heating board for better transferring effect
- Teflon coated upper heat platen
- High - grade model, suitable for exportation

## ▼ Specifications

Model	HTM-HP3805	
Working Size	15" x 15" (38cm x 38cm)	15" x 24" (38cm x 58cm)
Voltage	AC 110V, 60Hz / AC 220V, 50Hz	AC 110V, 60Hz / AC 220V, 50Hz
Power	1400W	1800W
Time Range	0 - 999S	0 - 999S
Temperature Range	0 - 399°C	0 - 399°C
<b>Price</b>	≤ \$380	≤ \$476

**HTM-HP3808: Swing - away Manual Heat Press Machine with Slide Out Table**

This heat press is widely used for T - shirt, table cloth, metal sheet, tile, etc.

- Swing - away design, convenient for preparation work
- Slide out style, the working table could be drew out for easy operation
- High pressure heat press to ensure the even pressure for perfect transferring effect
- The bottom of working table is hollow for inserting T - shirt to avoid any bad effect on imprinting side of T - shirt



## ▼ Specifications

Model	HTM-HP3808	
Working Size	15" x 15" (38cm x 38cm)	16" x 20" (40cm x 50cm)
Voltage	AC 110V, 60Hz / AC 220V, 50Hz	AC 110V, 60Hz / AC 220V, 50Hz
Power	1400W	1800W
Time Range	0 - 999S	0 - 999S
Temperature Range	0 - 399°C	0 - 399°C
<b>Price</b>	≤ \$454	≤ \$550



## ▼ Samples

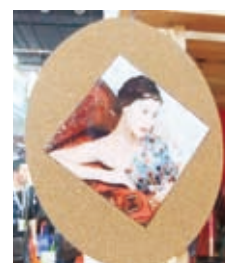

## > Heat Transfer Machine > T - shirt heat transfer machine

### HTM-HP3802: 15" x 15" High Pressure Manual Heat Press Machine

You can transfer any image to T - shirt, pillowcase, table cloth, metal sheet, etc.



- 15" x 15" Teflon coated heat platen
- High Pressure Heat Press style
- Real - time display of temperature equipped with automatic alarm
- Over - center pressure adjustment for easy pressure control

#### ▼ Specifications

Model	HTM-HP3802
Working Size	15" x 15" (38cm x 38cm)
Voltage	AC 110V, 60Hz / AC 220V, 50Hz
Power	1400W
Time Range	0 - 999S
Temperature Range	0 - 399°C
<b>Price</b>	<b>≤ \$216</b>



### HTM-HP3803: European Manual Heat Press Machine

You can transfer any image to T - shirt, pillowcase, table cloth, metal sheet, etc.

- Thicker heating panel
- Teflon coated upper heat platen
- Durable and easy to operate
- Delicate design and reasonable structure

#### ▼ Specifications

Model	HTM-HP3803	
Working Size	15" x 15" (38cm x 38cm)	16" x 20" (40cm x 50cm)
Voltage	AC 110V, 60Hz / AC 220V, 50Hz	AC 110V, 60Hz / AC 220V, 50Hz
Power	1400W	1800W
Time Range	0 - 999S	0 - 999S
Temperature Range	0 - 399°C	0 - 399°C
<b>Price</b>	<b>≤ \$275</b>	<b>≤ \$312</b>



#### ▼ Samples

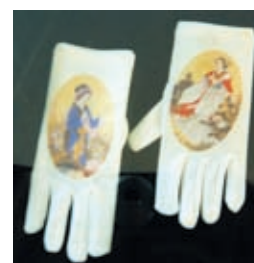
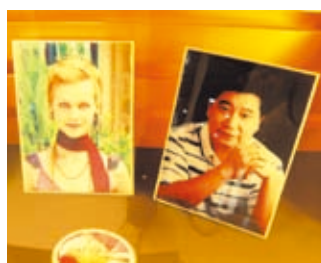

## &gt; Heat Transfer Machine &gt; T - shirt heat transfer machine

**HTM-HP450: 16" x 20" High - pressure Manual Heat Press Machine**

You can transfer any image to T - shirt, pant, table cloth, metal sheet, etc.



- High pressure style
- Leverage pressure design
- LED integrated display dashboard
- Adopting electromagnetic induction technique to countdown
- High quality digital controller makes it working more accurate
- Thicker heating board and more even pressure and heating guarantee top grade job
- Surface of heating panel is coated with anti - cohesion layer and no need insulation cloth

**▼ Specifications**

Model	HTM-HP450
Working Size	16" x 20" (40cm x 50cm)
Voltage	AC 110V, 60Hz / AC 220V, 50Hz
Power	1800W
Time Range	0 - 999S
Temperature Range	0 - 399°C
<b>Price</b>	<b>≤ \$300</b>

**HTM-CP3815: 2 in 1 Combo Heat Press Machine**

It's a special clamp heat press to transfer caps and flat items, just like T - shirt, tile, metal sheets, pillowcases, etc.

- Combo type, for transferring images on caps, tiles, metal sheets, etc
- Swing - away design, easy for preparation work
- Adjustable knob to ensure suitable pressure
- Integrated time and temperature controller, and it'll warn when time is up

**▼ Specifications**

Model	HTM-CP3815
Working Size	Flat panel: 4.7" x 4.7" (12cm x 12cm) Cap panel: 3.1" x 5.5" (8cm x 14cm)
Voltage	AC 110V, 60Hz / AC 220V, 50Hz
Power	550W
Time Range	0 - 999S
Temperature Range	0 - 380°C
<b>Price</b>	<b>≤ \$300</b>

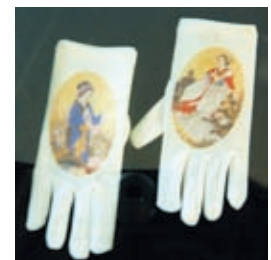
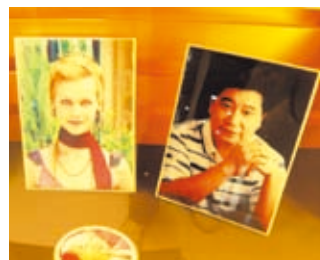
**▼ Samples**

## > Heat Transfer Machine > T - shirt heat transfer machine

### HTM-HP230A: 9" x 12" Smart Manual Heat Press Machine

This machine is widely used for transferring images on T - shirt, ceramic sheet, metal sheet, etc. It's especially for transferring logo on cloth.

- Fashionable design, high - grade modeling
- Adopt intelligent digital thermostat showing temperature precisely
- Integrated time & temperature controller, and it'll warn when time is up
- Teflon coated heater is easy to clean and anti - stick for good transferring effect
- Adopting air spring for convenient and easy operation
- The heating panel is good because of even heating distribution to ensure perfect transferring



#### ▼ Specifications

Model	HTM-HP230A
Working Size	9" x 12" (23cm x 30cm)
Voltage	AC 110V, 60Hz / AC 220V, 50Hz
Power	600W
Time Range	0 - 999S
Temperature Range	0 - 300°C
<b>Price</b>	<b>≤ \$216</b>

### HTM-HP230B: 9" x 12" Swing - away Manual Heat Press Machine

It is widely used for transferring small T - shirt, bag, pillowcase and others which are made of textile, knitting, non - woven, chemical fiber or cotton materials, and metal sheet, etc.



- Swing - away design makes it more safe and convenient for working
- Smart, light and easy to take
- Full LED digital display
- Touched controller is easier to operate
- Adopting the latest technology, the heating pipes and heating panel are molded together

#### ▼ Specifications

Model	HTM-HP230B
Working Size	9" x 12" (23cm x 30cm)
Voltage	AC 110V, 60Hz / AC 220V, 50Hz
Power	600W
Time Range	0 - 999S
Temperature Range	0 - 399°C
<b>Price</b>	<b>≤ \$173</b>

#### ▼ Samples

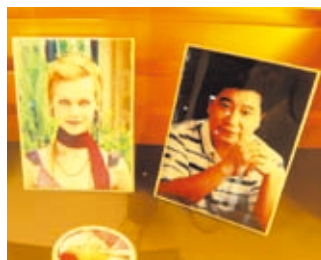

## &gt; Heat Transfer Machine &gt; T - shirt heat transfer machine

**HTM-ATM-LCB1: Pneumatic Swing - away Heat Press Machine**

You can transfer any image to T - shirt, pillowcase, table cloth, metal sheet, etc.



- Temperature and time with electronic control
- With manual and automatic device
- Return to normal situation when work finished
- Adjust pressure accurately to ensure the perfect printing effect
- Swing away style with air automatic handle
- Emergency - Stop button, more convenient and safe to use

**▼ Specifications**

Model	HTM-ATM-LCB1	
Working Size	15" x 15" (38cm x 38cm)	16" x 20" (40cm x 50cm)
Voltage	AC 110V, 60Hz / AC 220V, 50Hz	AC 110V, 60Hz / AC 220V, 50Hz
Power	1400W	1800W
Time Range	0 - 60S	0 - 60S
Temperature Range	0 - 380°C	0 - 380°C
<b>Price</b>	<b>≤ \$550</b>	<b>≤ \$723</b>

**HTM-LCB2: Economic Pneumatic Double Working Table Heat Press Machine**

It is widely used for transferring images to T - shirt, fabric bag, pillowcase and others which are made of textile, knitting, non - woven, chemical fiber or cotton materials, and metal sheet, adornment, etc.

- Adopting auto - moving technology
- Pneumatic double working tables for high speed printing
- Counterpoint of heating panel and working table is accurate
- Surface of heating panel is specially processed to be heat - resisting, smooth, and easy to clean
- It's convenient and easy to operate

**▼ Specifications**

Model	HTM-ATM-LCB2	
Working Size	15" x 15" (38cm x 38cm)	16" x 20" (40cm x 50cm)
Voltage	AC 110V, 60Hz / AC 220V, 50Hz	AC 110V, 60Hz / AC 220V, 50Hz
Power	1400W	1800W
Time Range	0 - 60S	0 - 60S
Temperature Range	0 - 380°C	0 - 380°C
<b>Price</b>	<b>≤ \$878</b>	<b>≤ \$945</b>

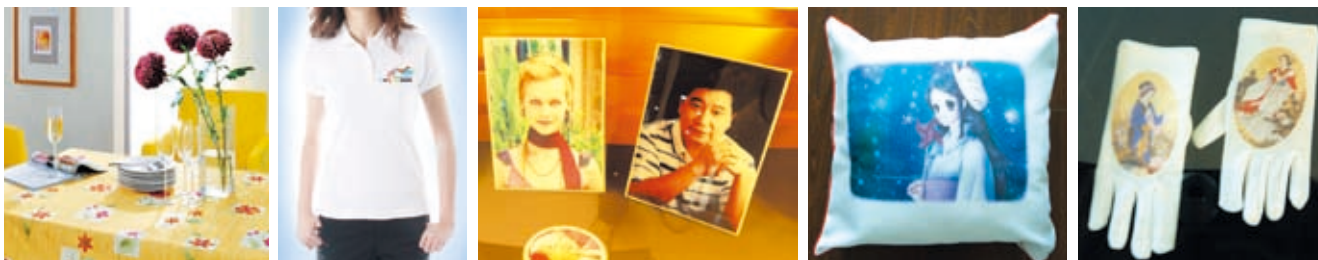
**▼ Samples**



## &gt; Heat Transfer Machine &gt; T - shirt heat transfer machine

**HTM-LCB4: Larger Format Pneumatic Double - working Table Heat Press Machine for Pull - out Style**

It is widely used for T - shirt, fabric bag, pillowcase and others which are made of textile, knitting, non - woven, chemical fiber or cotton materials, and metal sheet, adornments, etc.

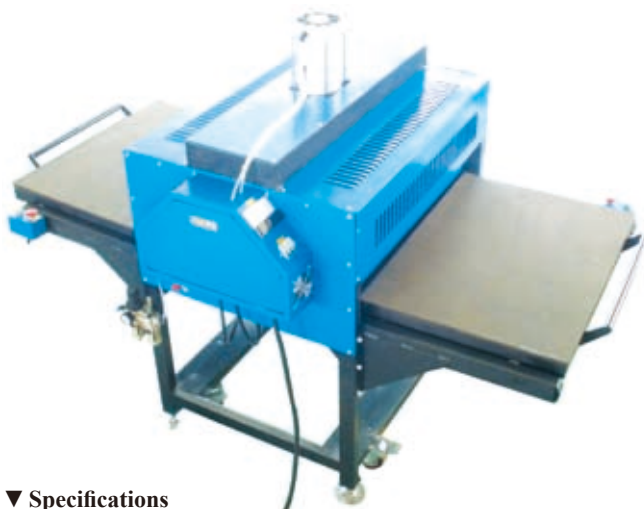

- Pneumatic Pattern, double working tables & Pull - out Style
- High temperature processing makes the heat panel pretty, glossy, and easy to clean
- Large format working table, suitable for large size transferring work
- It could be used for sublimation and heat transfer work
- For advertising industry and printing industry use
- High efficient because of its large format working table



Voltmeter



Display controller



Barometer



Inside structure



Emergency button



Universal pulleys

## ▼ Specifications

Model	HTM-ATM-LCB4		
Working Size	24" x 32" (60cm x 80cm)	31" x 39" (80cm x 100cm)	39" x 48" (100cm x 120cm)
Voltage (Three Phase)	AC 220V, 60HZ / AC 380V, 50HZ	AC 220V, 60HZ / AC 380V, 50HZ	AC 220V, 60HZ / AC 380V, 50HZ
Power	13.5KW	13.5KW	13.5KW
Time Range	0 - 60S	0 - 60S	0 - 60S
Temperature Range	0 - 380°C	0 - 380°C	0 - 380°C
Price	≤ \$1,983	≤ \$2,399	≤ \$2,984

**HTM-LCB5N: Pneumatic Heat Press Machine with Four Stations**

- Pneumatic Heat press machine works automatically
- Four working tables for high efficient works
- Air pressure coordinates with motor could make the working table be changed automatically



Intelligent control center



Motor

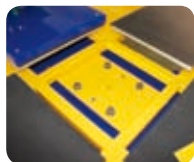

Working table



Motor drive gear



## ▼ Specifications

Model	HTM - LCB5N		
Working Size	15" x 15" (38cm x 38cm)	16" x 20" (40cm x 50cm)	16" x 24" (40cm x 60cm)
Voltage	AC 110V, 60Hz / AC 220V, 50Hz	AC 110V, 60Hz / AC 220V, 50Hz	AC 110V, 60Hz / AC 220V, 50Hz
Power	3400W	3700W	4000W
Time Range	0 - 999S	0 - 999S	0 - 999S
Temperature Range	0 - 380°C	0 - 380°C	0 - 380°C
Price	≤ \$2,500	≤ \$2,809	≤ \$3,064



Packing

## &gt; Heat Transfer Machine &gt; T - shirt heat transfer machine

**HTM-500THA: 20" x 39" Digital Manual Heat Press Machine**

It is professional for transferring images to expansive media, such as table cloth, T - shirt, table cloth and others which are with flat surface made of textile, chemical fiber or cotton materials, and metal sheet, adornment, etc.

- Large format, it's suitable for expansive media
- Accurate time and temperature display
- Enough output power for convenient using
- Great work is well done because of heating evenly distributed
- Delicate workmanship is accepted by most customers

**▼ Specifications**

Model	HTM - 500THA
Working Size	20" x 39" (50cm x 100cm)
Voltage (Three Phase)	AC 220V, 60Hz / AC 380V, 50Hz
Power	6000W
Time Range	0 - 999S
Temperature Range	0 - 260°C
<b>Price</b>	<b>≤ \$1,816</b>

**HTM-406THA: 16" x 20" High Quality Swing - away Manual Heat Press Machine**

It is suitable for transferring image to table cloth, T-shirts, bags, pillowcase and metal sheet, adornment, etc.



- Swing - away style, energy and manpower saving
- Two separate digital controllers for an easier view
- Accurate time and temperature display
- With a convenient head - shaking performance, there is enough room to place the T - shirts
- Heating is evenly distributed to guarantee a good work
- Most customers appreciate the delicate workmanship

**▼ Specifications**

Model	HTM-406THA
Working Size	16" x 20" (40.6cm x 50.8cm)
Voltage	AC 110V, 60Hz / AC 220V, 50Hz
Power	2500W
Time Range	0 - 999S
Temperature Range	0 - 399°C
<b>Price</b>	<b>≤ \$837</b>

**▼ Samples**

## > Heat Transfer Machine > T - shirt heat transfer machine

### HTM-380-2QTH: High Quality Pneumatic Heat Press Machine with Double Working Tables

It is suitable for transferring image to table cloth, T - shirt, bag, pillowcase and metal sheet, adornment, etc.

- Pneumatic pattern, automatic type
- Two working table for high efficient
- Digital control by the SCM program ensures the high precision and sensitivity
- Count automatically and it will alarm when the temperature goes higher than the one you set
- The changing among the spare parts is available when necessary
- Adopting advanced technology and good material for better effect

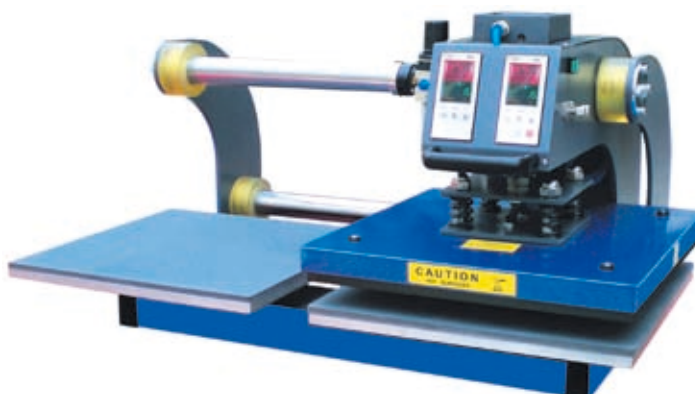

#### ▼ Specifications

Model	HTM-380-2QTH	
Working Size	15" x 15" (38cm x 38cm)	15" x 20" (38cm x 50cm)
Voltage	AC 110V, 60Hz / AC 220V, 50Hz	AC 110V, 60Hz / AC 220V, 50Hz
Power	2200W	2500W
Time Range	0 - 999S	0 - 999S
Temperature Range	0 - 399°C	0 - 399°C
<b>Price</b>	<b>≤ \$1,013</b>	<b>≤ \$1,105</b>

### HTM-380: 15" x 15" Manual Digital Heat Press Machine

It is suitable for transferring image to table cloth, T - shirt, bag, pant and metal sheet, adornment, etc.

- LCD displays show the temperature value and the time
- Integrated electric control system for simple adjustment and maintenance
- The temperature is even and stable
- Surface of heating panel is coated with anti - cohesion layer
- Easy to operate and maintain
- Digital control by the SCM program PID operation PWM way of output, all of which extend the life - span and save power



#### ▼ Specifications

Model	HTM-380
Working Size	15" x 15" (38cm x 38cm)
Voltage	AC 110V, 60Hz / AC 220V, 50Hz
Power	2200W
Time Range	0 - 999S
Temperature Range	0 - 399°C
<b>Price</b>	<b>≤ \$519</b>

#### ▼ Samples



## &gt; Heat Transfer Machine &gt; T - shirt heat transfer machine

**HTM-100TH: 4" x 6" Mini Manual Digital Heat Press Machine**

It is suitable for transferring image to table cloth, T - shirt, bag, pillowcase and metal sheet, adornment, etc.



- Manual type
- Reasonable design, smart
- Delicate and durable, fine workmanship
- Widely used, you can transfer images to flat materials, such as T - shirt, cloth, metal sheet, etc

**▼ Specifications**

Model	HTM-100TH
Working Size	4" x 6" (10cm x 15cm)
Voltage	AC 110V, 60Hz / AC 220V, 50Hz
Power	400W
Time Range	0 - 999S
Temperature Range	0 - 399°C
<b>Price</b>	<b>≤ \$444</b>

**HTM-DS-2TH: Manual Digital Heat Press Machine with Double Working Tables**

It is suitable for transferring image to table cloth, T - shirt, bag, pillowcase and metal sheet, adornment, etc.

- Manual type, fine workmanship
- High efficient working, double working table
- Digital control by the SCM program ensures the high precision and sensitivity
- Count automatically and it will alarm when the temperature goes higher than the one you set
- The change between Centigrade and Fahrenheit is available

**▼ Specifications**

Model	HTM-DS-2TH		
Working Size	6" x 8" (10cm x 15cm)	8" x 12" (20cm x 30cm)	12" x 15" (30cm x 38cm)
Voltage	AC 110V, 60Hz / AC 220V, 50Hz	AC 110V, 60Hz / AC 220V, 50Hz	AC 110V, 60Hz / AC 220V, 50Hz
Power	500W	800W	1200W
Time Range	0 - 999S	0 - 999S	0 - 999S
Temperature Range	0 - 399°C	0 - 399°C	0 - 399°C
<b>Price</b>	<b>≤ \$465</b>	<b>≤ \$508</b>	<b>≤ \$580</b>

**▼ Samples**

## > Heat Transfer Machine > Mug & plate heat transfer machine

### HTM-MP2105: Mug Heat Press Machine with Separate Display Controllers

It's used for transferring images as you like to mugs.



- Vertical type, easy operation
- Facilitate for adjustment of pressure
- Time and temperature displays design individually
- The heating panel employs the special precision spool technology, which can effectively ensure the evenness and stability of temperature.

#### ▼ Specifications

Model	HTM-MP2105
Working Size	φ 2.95" - φ 3.35" (φ 7.5cm - φ 8.5cm)
Voltage	AC 110V, 60Hz / AC 220V, 50Hz
Power	450W
Time Range	0 - 999S
Temperature Range	0 - 399°C
<b>Price</b>	<b>≤ \$135</b>



### HTM-MP105: Economical Smart Mug Heat Press Machine

It's used for transferring images as you like to mugs.

- Vertical type, easy operation
- Smart and portable machine, easy to carry
- Time and temperature displays design individually
- The heating panel employs the special precision spool technology, which can effectively ensure the evenness and stability of temperature.

#### ▼ Specifications

Model	HTM-MP105
Working Size	φ 2.95" - φ 3.35" (φ 7.5cm - φ 8.5cm)
Voltage	AC 110V, 60Hz / AC 220V, 50Hz
Power	450W
Time Range	0 - 999S
Temperature Range	0 - 399°C
<b>Price</b>	<b>≤ \$97</b>



#### ▼ Samples



## &gt; Heat Transfer Machine &gt; Mug &amp; plate heat transfer machine

**HTM-MP4105: Durable Vertical Mug Heat Press Machine**

It's used for transferring images as you like to mugs.

- Vertical type, easy operation
- Delicate outer appearance and accurate display
- Time and temperature displays design integrated
- The heating panel employs the special precision spool technology, which can effectively ensure the evenness and stability of temperature

**▼ Specifications**

Model	HTM-MP4105
Working Size	φ 2.95" - φ 3.35" (φ 7.5cm - φ 8.5cm)
Voltage	AC 110V, 60Hz / AC 220V, 50Hz
Power	450W
Time Range	0 - 999S
Temperature Range	0 - 399°C
<b>Price</b>	<b>≤ \$135</b>

**HTM-MP160: Mug Heat Press Machine for Cone & Cylinder Mugs**

It's used for transferring images as you like to mugs. The machine is not only for transferring cone mugs but also for cylinder mugs.

- Unique cone coaster, available to cone mugs
- Bigger digital display dashboard for easy observation
- Easy pressure adjustment and nice out appearance
- Digital control makes it easy to operate
- Two tablemats make it convenient to change and available for cone mugs and round - shape mugs. Bigger digital display dashboard for easy observation

**▼ Specifications**

Model	HTM-MP160
Working Size	Cylinder Mug φ 2.95" - φ 3.35" (φ 7.5cm - φ 8.5cm); Upper: φ 2.16" - φ 2.56" (φ 5.5cm - φ 6.5cm) Cone Mug Bottom: φ 3.54" - 3.94" (9cm - 10cm) Height: 3.54" (9cm)
Voltage	AC 110V, 60Hz / AC 220V, 50Hz
Power	450W
Time Range	0 - 999S
Temperature Range	0 - 399°C
<b>Price</b>	<b>≤ \$168</b>

**▼ Samples**

## &gt; Heat Transfer Machine &gt; Mug &amp; plate heat transfer machine

**HTM-MP150 x 5: 5 in 1 High Efficient Mug Heat Press Machine**

It's used for transferring images as you like to mugs efficiently.



- Five heating mats for highly efficient working
- Fully digital temperature control
- Automatic digital timer
- Easy pressure adjustment
- Solid steel welded framework
- Digital control makes it easy to adjust pressure

**▼ Specifications**

Model	HTM-MP150 x 5
Working Size	φ 2.95" - φ 3.35" (φ 7.5cm - φ 8.5cm)
Voltage	AC 110V, 60Hz / AC 220V, 50Hz
Power	1500W
Time Range	0 - 999S
Temperature Range	0 - 399°C
<b>Price</b>	<b>≤ \$306</b>

**HTM-80TBA: High - quality Mug Heat Press Machine with Horizontal Type**

You can transfer any beautiful images as you like to mugs made of ceramic, glass, or metal by this mug heat press machine.

- Digital control by the SCM program
- Silica gel plate for heating to help deliver perfect effect
- Automatically controlled constant temperature
- It will alarm when the temperature is higher than that you set

**▼ Specifications**

Model	HTM-80TBA
Working Size	φ 2.95" - φ 3.35" (φ 7.5cm - φ 8.5cm)
Voltage	AC 110V, 60Hz / AC 220V, 50Hz
Power	280W
Time Range	0 - 999S
Temperature Range	0 - 399°C
<b>Price</b>	<b>≤ \$444</b>

**▼ Samples**

> Heat Transfer Machine > Mug & plate heat transfer machine

### HTM-CP815B: Swing - away Cap Heat Press Machine

It's used for transferring images as you like to the caps.

- Electronic, digital temperature and time display separately
- Vertical personalized design makes it easier and quicker to operate
- Microcomputer installed in separate box ensures the constancy of temperature thus easy to maintain
- Spiral pressure design allows random adjustment for working pressure
- Special fixing device, ensures the accuracy during printing



▼ Specifications

Model	HTM-CP815B
Working Size	3.15" x 5.90" (8cm x 15cm)
Voltage	AC 110V, 60Hz / AC 220V, 50Hz
Power	450W
Time Range	0 - 999S
Temperature Range	0 - 399°C
<b>Price</b>	<b>≤ \$171</b>



### HTM-CP815: Automatic Cap Heat Press Machine

It is widely used for the transferring of all kinds of images onto the caps.

- Air automatic with high efficiency.
- It is suitable for large production printing
- Save your time and money
- Teflon cloth between the cap heating mats can avoid the damage to image and make the image being transferred more clearly

▼ Specifications

Model	HTM-CP815
Working Size	4.72" x 7.08" (12cm x 18cm)
Voltage	AC 110V, 60Hz / AC 220V, 50Hz
Power	450W
Time Range	0 - 999S
Temperature Range	0 - 399°C
<b>Price</b>	<b>≤ \$465</b>





## > Heat Transfer Machine > Mug & plate heat transfer machine

### HTM-PT110: Plate Heat Transfer Machine

It's used for transferring images as you like to plates.



- Time and temperature integrated completely in one controller
- Fully digital temperature controller
- You can change the place in any size freely
- Adjusted voltage is available and smart

#### ▼ Specifications

Model	HTM-PT110
Working Size	φ 4.72" / φ 5.90" (φ 12cm / φ 15cm)
Voltage	AC 110V, 60Hz / AC 220V, 50Hz
Power	450W
Time Range	0 - 999S
Temperature Range	0 - 399°C
<b>Price</b>	<b>≤ \$171</b>



### HTM-PT110-2: Swing - away Plate Heat Press Machine

It's used for transferring images as you like to plates.

- Swing - away design, easy for prepare work
- Adjustable knob to ensure the suitable pressure
- Integrated time & temperature controller, and it'll warn when time is up

#### ▼ Specifications

Model	HTM-PT110-2
Working Size	φ 4.72" / φ 5.90" (φ 12cm / φ 15cm)
Voltage	AC 110V, 60Hz / AC 220V, 50Hz
Power	450W
Time Range	0 - 999S
Temperature Range	0 - 399°C
<b>Price</b>	<b>≤ \$182</b>



#### ▼ Samples



> Heat Transfer Machine > Badge making machine

### HTM-MA-001: Round Badge Making Machine

It's used for making kinds of badges.

- Fast slide track operation.
- It's available to change mould.
- Lowerest investment and biggest profit.
- Used to make DIY pin buttons, opener badges, rosette button, etc.



▼ Specifications

Model	HTM-MA-001								
Working Size	25mm (0.98")	32mm (1.25")	37mm (1.45")	44mm (1.73")	50mm (1.96")	56mm (2.20")	58mm (2.28")	75mm (2.95")	
Price	≤ \$92	≤ \$103	≤ \$103	≤ \$107	≤ \$129	≤ \$129	≤ \$130	≤ \$149	

### HTM-MA-002: New Round Badge Making Machine

It's used for pin button, opener button, mirror button with key - chain, rosette button, etc.

- Split mould is easy to use.
- Fast slide track operation.
- It's available to change mould.
- Lowerest investment and biggest profit.
- Used to make DIY pin buttons, opener badges, rosette button, etc.



▼ Specifications

Model	HTM-MA-002								
Working Size	25mm (0.98")	32mm (1.25")	37mm (1.45")	44mm (1.73")	50mm (1.96")	56mm (2.20")	58mm (2.28")	75mm (2.95")	
Price	≤ \$142	≤ \$145	≤ \$149	≤ \$151	≤ \$156	≤ \$156	≤ \$157	≤ \$178	

### HTM-MA-003: Aluminum Badge Making Machine

It's used for pin button, opener button, and mirror button with key - chain, rosette button, etc

- Aluminum alloy cast iron, no rust.
- Triangle support stand made of solid metal is for balans stress.
- Handle with double color is beautiful and comfortable.
- Threaded fittings is easy for dismounting.
- Adopt the bearing mechanics for easily press.
- Acrylic bottom plate, and thickness is up to 11mm.
- Used to make DIY pin buttons, opener badges, rosette button, etc.



▼ Specifications

Model	HTM-MA-003									
Working Size	25mm (0.98")	32mm (1.25")	37mm (1.45")	44mm (1.73")	50mm (1.96")	56mm (2.20")	58mm (2.28")	75mm (2.95")	100mm (3.93")	
Price	≤ \$115	≤ \$116	≤ \$148	≤ \$150	≤ \$155	≤ \$155	≤ \$155	≤ \$173	≤ \$264	

▼ Samples



## &gt; Heat Transfer Machine &gt; Badge making machine

**HTM-MA-CF68: Rectangle Badge Making Machine for 68mm x 24mm (2.68" x 0.94") Badges**

It's used for rectangle pin button, opener button, mirror button, etc.

- Full aluminum body.
- Swing away working plate.
- Fast slide track operation.
- It's available to change mould.
- Lowerest investment and biggest profit.
- Used to make DIY pin buttons, opener badges, rosette button, etc.

## ▼ Specifications

<b>Model</b>	<b>HTM-MA-CF68</b>
Working Size	68mm x 24mm (2.68" x 0.94")
<b>Price</b>	≤ \$351

**HTM-MA-006: Large Round Badge Making Machine for 158mm (6.22") Badges**

It's used for pin button, clock, mirror, money - saving box, photo stander etc.

- Split mould is easy to use.
- Fast slide track operation.
- It's available to change mould.
- Lowerest investment and biggest profit.
- For making big size buttons, such as clock, mirror, photo stander, etc.

## ▼ Specifications

<b>Model</b>	<b>HTM-MA-006</b>
Working Size	158mm (6.22")
<b>Price</b>	≤ \$554

**HTM-AUTO-001: Automatic Round Badge Making Machine**

It's used for pin button, opener button, mirror button with key - chain, rosette button, etc.

- Automatic type and high efficient.
- Split mould is easy to use.
- Fast slide track operation.
- It's available to change mould.
- Lowerest investment and biggest profit.
- Used to make DIY pin buttons, opener badges, rosette button, etc.



## ▼ Specifications

<b>Model</b>	<b>HTM-AUTO-001</b>								
Working Size	25mm (0.98")	32mm (1.25")	37mm (1.45")	44mm (1.73")	50mm (1.96")	56mm (2.20")	58mm (2.28")	75mm (2.95")	
<b>Price</b>	≤ \$1,560	≤ \$1,567	≤ \$1,575	≤ \$1,582	≤ \$1,597	≤ \$1,597	≤ \$1,597	≤ \$1,657	

## ▼ Samples



## &gt; Heat Transfer Machine &gt; Heat press starter kit

**CS-HTS-001: T - Shirt Heat Press Kit**

This solution is widely used for transferring image to T - shirt, pillowcase, table cloth, metal sheet, etc. It is including machines and transfer consumables for convenient transferring.

- **Firstly**, using a piezoelectric printer (For example: EPSON R230 printer) to print the picture onto the sublimation paper.
- **Secondly**, put the paper on the surface of the T-shirt and check the position of the picture.
- **Thirdly**, use adhesive sticker to fix the paper and put the T - shirt on the heat transfer machine, and then through pressing and heating, transfer the picture onto the T-shirt and make the color stable.

**▼ Including**

- One set of heat transfer machine
- One EPSON Printer (Epson R230 with voltage of 220V)
- One set of continuous ink supply including heat transfer ink 100ml in every color
- One parcel sublimation paper (A4 size, 100pcs / parcel)
- One parcel of T - shirt (10pcs / parcel, non - cotton)

**Price:** ≤ \$933

**CS-HTS-002: Cap Heat Press Kit**

This solution is for transferring image to caps. It is including machines and transfer consumables for convenient transferring.

- **Firstly**, use a piezoelectric printer (For example: EPSON R230 printer) to print the picture onto the sublimation paper.
- **Secondly**, put the paper on the surface of the cap and check the position of the picture.
- **Thirdly**, use adhesive sticker to fix the paper and put the cap on the heat transfer machine, and then through pressing and heating, transfer the picture onto the cap and make the color stable.

**▼ Including**

- One set of the cap heat transfer machine
- One EPSON Printer (Epson R230 with voltage of 220V)
- One set of the continuous-ink-supply system including heat transfer ink 100ml in six-color
- One parcel of heat transfer paper (100pcs / parcel)

**Price:** ≤ \$621

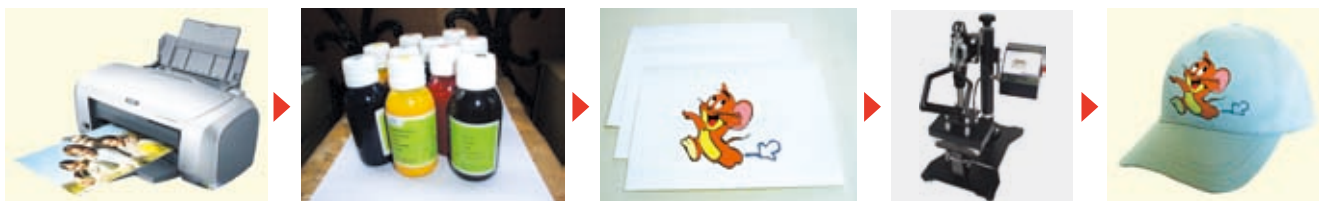

## &gt; Heat Transfer Machine &gt; Heat press starter kit

**CS-HTS-003: Mug Heat Press Kit**

This solution is for transferring image to mugs. It is including machines and transfer consumables for convenient transferring.



- **Firstly**, use a piezoelectric printer (For example: EPSON R230 printer) to print the picture onto the sublimation paper.
- **Secondly**, put the paper on the surface of the mug and check the position of the picture.
- **Thirdly**, use adhesive sticker to fix the paper and put the mug on the heat transfer machine, and then through pressing and heating, transfer the picture onto the mug and make the color stable.

**▼ Including**

- One set of mug heat transfer machine
- One EPSON Printer (Epson R230 with voltage of 220V)
- One set of continuous - ink - supply device (6 colors, with heat transfer ink 100ml each color)
- One parcel of heat transfer paper (100pcs / parcel)
- One box of white mugs with the diameter of 8.2cm (36pcs / box)

**Price:** ≤ \$635

**CS-HTS-004: Plate Heat Press Kit**

This solution is for transferring image to plates. It is including machines and transfer consumables for convenient transferring.

- **Firstly**, use a piezoelectric printer (For example: EPSON R230 printer) to print the picture onto the sublimation paper.
- **Secondly**, put the paper on the surface of the plate and check the position of the picture.
- **Thirdly**, use adhesive sticker to fix the paper and put the plate on the heat transfer machine, and then through pressing and heating, transfer the picture onto the plate and make the color stable.

**▼ Including**

- One set of plate heat transfer machine
- One EPSON Printer (Epson R230 with voltage of 220V)
- One set of continuous - ink - supply device (6 colors, with heat transfer ink 100ml each color)
- One parcel of heat transfer paper (100pcs / parcel)

**Price:** ≤ \$673



> Heat Transfer Machine > Heat press accessories & badge mold

**CS-3D11M: 11OZ Mug Clamper**

Size: 11OZ  
 Material: Heat - resistant silicon and metal  
 Price: ≤ \$7.44



**CS-3D12M: 12OZ Conical Mug Clamper**

Size: 12OZ  
 Material: Heat - resistant silicon and metal  
 Price: ≤ \$7.44



**CS-3D15M: 15OZ Mug Clamper**

Size: 15OZ  
 Material: Heat - resistant silicon and metal  
 Price: ≤ \$7.44



**CS-3DGJ: Cappie Clamper**

Size: 1.5OZ  
 Material: Heat - resistant silicon and aluminum board  
 Weight: silicon: 145g, aluminum board: 540g  
 Qty/time: 7pcs  
 Price: ≤ \$19.83



**CS-PH-3D4M: Iphone4 / 4S Mold**

Material: Aluminum Alloy  
 Application: For transferring Iphone covers  
 Price: ≤ \$14.88



**CS-PH-3D5M: Iphone5 Mold**

Material: Aluminum Alloy  
 Application: For transferring Iphone covers  
 Price: ≤ \$14.88



**CS-PH-3DS3M: Samsung S3 9300 Mold**

Material: Aluminum Alloy  
 Application: For transferring samsung phone covers  
 Price: ≤ \$14.88



**CS-PH-3DN2M: Samsung Note2 7100 Mold**

Material: Aluminum Alloy  
 Application: For transferring samsung phone covers  
 Price: ≤ \$17.52



**CS-PH-3DH1XM: HTC one X Mold**

Material: Aluminum Alloy  
 Application: For transferring HTC phone covers  
 Price: ≤ \$38.02



**CS-PAD-3DMNM: Ipad Mini Mold**

Material: Aluminum Alloy  
 Application: For transferring Ipad Mini covers  
 Price: ≤ \$38.02



**CS-PAD-3DM: Ipad 2& 3 Mold**

Material: Aluminum Alloy  
 Application: For transferring Ipad 2 or Ipad 3 covers  
 Price: ≤ \$42.15



**CS-3DVF: A3 Size Vacuum Film**

Material: heat - resistant silicon film  
 Size: 300mm x 420mm (11.8" x 16.5")  
 Weight: 175g  
 Color: white  
 Price: ≤ \$8.26



**CS-DC Series One Piece Mould For Round Badge**

Material: Mold: Aluminum alloy and iron  
 Slide Track: Plastic  
 Type: One - piece mould  
 Application: It's used for making round badge  
 Applicable machine model: HTM-MA-001 series, HTM-MA-003



▼ Specifications

Model	CS-DC Series							
Working Size	25mm (0.98")	32mm (1.25")	37mm (1.45")	44mm (1.73")	50mm (1.96")	56mm (2.20")	58mm (2.28")	75mm (2.95")
Price	≤ \$49.26	≤ \$52.40	≤ \$54.21	≤ \$61.49	≤ \$65.79	≤ \$65.79	≤ \$65.79	≤ \$84.63

**CS-DCL Series One Piece Durable Metal Mould For Round Badge**

Material: Mold: Aluminum alloy and iron  
 Slide Track: Aluminum  
 Type: One - piece mould  
 Application: It's used for making round badge  
 Applicable machine model: HTM-MA-001 series



▼ Specifications

Model	CS-DCL Series							
Working Size	25mm (0.98")	32mm (1.25")	37mm (1.45")	44mm (1.73")	50mm (1.96")	56mm (2.20")	58mm (2.28")	75mm (2.95")
Price	≤ \$66.12	≤ \$68.60	≤ \$73.22	≤ \$78.02	≤ \$82.64	≤ \$82.64	≤ \$84.30	≤ \$107.27



**CS-DCW Series Split Mould For Round Badge**

Material: Mold: Aluminum alloy and iron  
 Slide Track: Aluminum  
 Type: Split mould  
 Application: It's used for making round badge  
 Applicable machine model: HTM-MA-002 series, HTM-MA-008 series

▼ Specifications

Model	CS-DCW Series							
Working Size	25mm (0.98")	32mm (1.25")	37mm (1.45")	44mm (1.73")	50mm (1.96")	56mm (2.20")	58mm (2.28")	75mm (2.95")
Price	≤ \$66.12	≤ \$68.60	≤ \$73.22	≤ \$78.02	≤ \$82.64	≤ \$82.64	≤ \$84.30	≤ \$107.27

> Flatbed Printer & Supplies

### SIC-SZSLJ-A3C: A3+ Size 6 - Color Flatbed Printer

#### ▼ Applicable Printing Materials

**Organic materials:** Acrylic, plastics (ABS, PVC, PP, PE, PU), leather, wooden articles, textile fabric, silica gel, etc.

**Inorganic material:** Ceramics, glass, stone, crystal, etc.

**Metallic materials:** Gold, silver, copper, iron, stainless steel, aluminum alloy, etc.

- **Easy operation:** No need to plate making and repeating color registering processes.
- **Printing on the substance with flat or slight curved surfaces:** A maximum concave - convex discrepancy of 7mm is allowed, with a perfect printing effect.
- **High printing speed and resolution:** A4 printing: 2 minutes - 1440DPI, 5 minutes - 2880DPI.
- **Professional software output:** The best printing effect with 100% color rendition.
- **Actuating device:** With a combination of the step motor and synchronous belt to guarantee more precise printing resolution.
- **Printhead protector:** Auto induction to protect the printheads by adjusting the height.
- **Allayed working table:** Lighter, higher stability and resolution.



Control panel



Electrical system



High resolution gearing

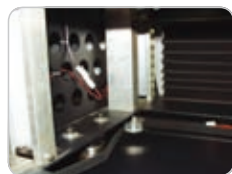

Firm structure



Ink supply tank



Waste ink tank



#### ▼ Specifications

<b>Printing Mode</b>	6 - color Ink Jet (Y, M, C, K, Lc, Lm)	<b>Maximum Printing Width</b>	329mm x 480mm (13" x 23.6")
<b>Resolution</b>	5760 x 1440dpi	<b>Maximum Thickness of Material</b>	200mm (7.9")
<b>Nozzle Configuration</b>	540Nozzles (90 nozzles x 6colors)	<b>Minimum Ink Droplet</b>	1.5 Pico-liters
<b>Printing Speed</b>	A3, 3mins photo quality mode.	<b>Power Supply</b>	AC220 - 240V / AC110 - 120V, 50Hz ~ 60Hz
<b>Transmission Type</b>	USB2.0	<b>Working Environment</b>	Temperature: 5 ~ 35°C; Humidity: 20 ~ 80%
<b>Machine Weight</b>	176.4lb (80kg)	<b>Driver</b>	Microsoft Windows 98 / 2000 / Me / XP
<b>Machine Dimension</b>	890mm x 750mm x 565mm (35" x 29" x 22")	<b>Jet Cleaning Type</b>	Automatic
<b>Price</b>	≤ \$3,728 / set	<b>Ink Feed Type</b>	150ml / Color (6 Colors)

#### ▼ Samples



## &gt; Flatbed Printer &amp; Supplies

**SIC-QDYN-TMN09: A3 Size T - shirt Printer**

This machine is popular with our clients once it was launched into the market. Customers can save their own photos, design and more, into the software and then print them directly on the t - shirt.

- Color durability on t - shirt.
- Print directly on the t - shirt, there is no need of coating.
- Fast speed print.
- With one click you can get clean the ink head, easier to use.

## ▼ Specifications

Model	SIC-QDYN-TMN09
Printing Speed	A4, full-format, full-color, 60 sec
Maximum Printing Width	297mm x 420mm (11.6" x 16.5")
Printer Resolution	5760 x 1440dpi
Power Supply	220V, 50Hz / 110V, 60Hz
Machine Dimension	500mm x 1060mm x 350mm (20" x 42" x 14")
Machine Weight	88.2lb (40kg)
<b>Price</b>	<b>≤ \$4,178 / set</b>



## ▼ Samples

**SIC-CD-CZH-08FZ: T - Shirt Printer**

**Applications:** T-shirt printing, textile printing, leather printing.

- Break stereotypes, innovative appearance.
- Perfect and fast mode of production is unmatched the traditional craft methods.
- It can support black T - shirt printing.
- 8-Color ink tanks, easy - to - install.
- Industrialized print machine.
- Auto online, save power mode, low cost printing.

## ▼ Samples

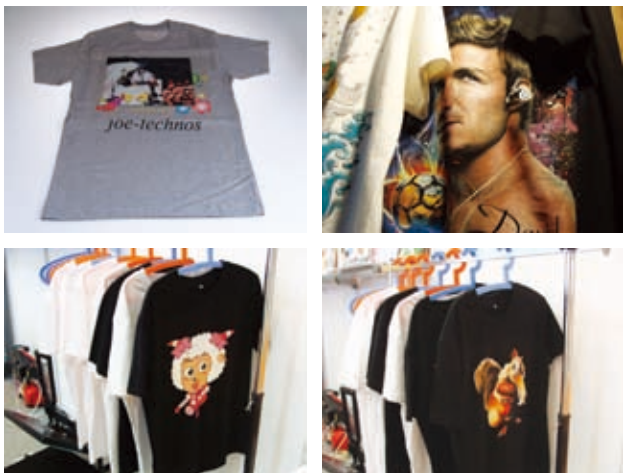

## ▼ Specifications

Model	SIC-CD-CZH-08FZ
Printing Mode	8 - color Ink Jet
Maximum Printing Width	380mm x 480mm (15" x 19")
Maximum Thickness of Material	20mm (0.8")
Resolution	1440dpi x 2880dpi
Printing Speed	A4, full - format, full - color, 100 sec.
Transmission Type	Universal Serial Bus (USB)
Power Supply	AC220 / 110 ± 10, 50Hz ~ 60Hz Power ≤ 450W
Driver	Microsoft Windows 98 / 2000 / Me / XP MacOS9.1 or higher
Ink Feed Type	1760ml (220ml / color)
Machine Dimension	850mm x 810mm x 390mm (33" x 32" x 15")
Machine Weight	198lb (90kg)
<b>Price</b>	<b>≤ \$6,710 / set</b>





## > Flatbed Printer & Supplies

### SIC-GZJH-A1UV: A1 LED UV Flatbed Printer

LED UV flatbed printer has opaque white ink performance for higher - quality printing on dark materials. Printing ink dry instantly, emboss output images with 3D effect, increase your products added value and give higher competitive ability in the market, while other printing technology can't.

#### ▼ Specifications

Model	SIC-GZJH-A1UV
Printing Mode	C, M, Y, K, +4W
Maximum Printing Width	600mm x 1500mm (23.6" x 59")
Maximum Thickness of Material	120mm (4.72")
Resolution	1440dpi x 2880dpi
Printing Speed	A1 (1440dpi) / 10min
Transmission Type	Universal Serial Bus (USB)
Power Supply	AC 220V / 110V ± 10, 50Hz ~ 60Hz
Driver	Windows XP, WIN7 32bit
Ink Feed Type	220ml / color
Machine Dimension / Weight	2740mm x 1320mm x 1130mm (102" x 52" x 44") / 881lb (400kg)
<b>Price</b>	<b>≤ \$14,958</b>



- LED UV curing technology
- High - density opaque white ink
- Photo quality printing
- Supper printing width and high printing speed
- Direct printing onto materials



EPSON original board



Water cooling system for UV lamp



Configuration of dual LED UV lamp



Auto cleaning system

### SIC-GZJH-A3UV: A3+ LED UV Flatbed Printer

The UV flatbed printer is widely used and convenient for operation. It is attributed to a high yield machine in commercial return and the best choice for business beginners.

- LED UV offers decisive energy savings, longer diode lifetime and a close to no VOC\* emitting printing environment.
- White UV ink creates a very opaque image, allowing you to print vibrant colors onto virtually any colored or transparent substrate with 3D textured result.
- Automated ink circulation system that prevents the pigment in white ink from settling. This system automatically reduces waste of white ink, lowers running costs, produces exceptional image quality, and ensures consistent white density throughout the longest production runs.
- Because the integrated LED-UV lamp instantly cure ink during printing, The LED UV Flatbed can print directly onto materials such as PET, ABS, PVC, polycarbonate, PS and other plastics, as well as papers and card stocks.



150ml big ink tank



Auto cleaning system



Print area 320mm x 590mm



Epson original main board



Four colors & four white



Automated white ink circulation system

#### ▼ Samples



#### ▼ Specifications

Model	SIC-GZJH-A3UV
Printing Mode	C,M,Y,K,+4W
Maximum Printing Width	280mm x 590mm (11" x 23.2")
Maximum Thickness of Material	170mm (6.6")
Resolution	1440dpi x 5760dpi
Printing Speed	A3 (1440dpi) / 83s
Transmission Type	Universal Serial Bus (USB)
Power Supply	AC 220V / 110V ± 10, 50Hz ~ 60Hz
Driver	Windows XP, WIN7 32bit
Ink Feed Type	220ml / color
Machine Dimension	900mm x 750mm x 600mm (35" x 30" x 24") / 198.4lb (90kg)
<b>Price</b>	<b>≤ \$8,409</b>



## > Flatbed Printer & Supplies

### SIC-CALCA-DFP1800UV: CALCA DFP1800UV A3 Size LED UV Flatbed Printer

CALCA DFP1800UV flatbed printer is a new small size UV flatbed printer. With LED UV printing technology, it does not need any coating but print on materials directly; Supporting white ink, thus it has no limit of material colors, which creates more value to users. One machine costs is not much and users can quickly recover the costs.

- **LED UV environmental technology.**

LED UV printing technology is energy saving; UV ink is more environmentally friendly than other inks and it does not produce volatile gases.

- **Support white ink.**

CALCA A3 LED UV printer can print with white ink on transparent or dark color materials.

- **Smart design for easy transport.**

The machine is small and exquisite, easy for shipment by air or sea.

- **Wide application of personalized print.**

Suitable for printing on gifts, badges, signs, glasses, hair grip, cards, leather, PVC cards, crystal, U disk, mobile phone cases, IPAD cases and other materials.



100W water - cooling  
UV system



Auto cleaning system



Continuous big ink supply  
system



EPSON DX5 printhead  
(Original)



Digital stepper driver  
system

#### ▼ Specifications

Model	SIC-CALCA-DFP1800UV
Printing Mode	C, M, Y, K, +4W
Maximum Printing Width	270mm x 550mm (10.6" x 21.6")
Maximum Thickness of Material	90mm (3.5")
Resolution	1440dpi x 5760dpi
Printing Speed	Iphone Case 12pcs one time, BI - directional Print 6 mins
Transmission Type	Universal Serial Bus (USB)
Power Supply	AC 220V / 110V ± 10, 50Hz ~ 60Hz
Driver	Windows XP, WIN7 32bit
Machine Dimension	1000mm x 750mm x 520mm (39" x 30" x 20") / 154.31b (70kg)
<b>Price</b>	<b>≤ \$6,528</b>



Emergency stop device



Epson original main board



Four colors & four white



LED UV lamp

#### ▼ Samples

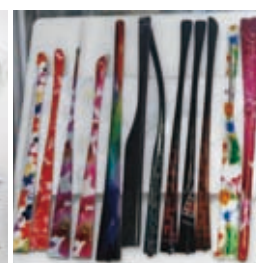

## SIC-CALCA-DFP1800: CALCA DFP1800 No Coating High Speed Eco-solvent Flatbed Printer



Calca DFP1800 is an small size no coating flatbed printer, printing high speed, low price, cost recovery block, suitable for low budgets and entry - level customers to buy.

- Original EPSON dx5 printhead
- No need coating to save cost drastically
- Directly print on the surface
- Printable object height can be up to 90mm
- Smart design for easy transport easy

### ▼ Applications

**Individualized printing:** Boutique, mobile phone decoration store, and gift shop, etc.

**Crystal selection:** On - site fabrication at scenic spots or down streets.

**Proofing:** Manufacture of various traditional printing proof plates.

**Photo studio:** Digital image production.

**Garment industry:** Proofing or color printing of pictures.

**Leather ware:** Color printing of top - grade leather goods.

**Electronic products:** Color printing of cassette - type disks, laptops cases, MP3 and MP4.

**Gift package:** Print color package.

**Signage production:** Different types of signage.

**Decoration industry:** Color print of ceramic tiles and ceilings.

**Toy industry:** Print cartoon work, comics and animations.



Auto cleaning system



Continuous big ink supply system



Digital stepper driver system



Emergency stop device system



EPSON DX5 printhead (Original)



Epson original main board

### ▼ Specifications



Model	SIC-CALCA-DFP1800
Printing Mode	Dual C, M, Y, K
Maximum Printing Width	320mm x 550mm (12.5" x 21.6")
Maximum Thickness of Material	90mm (3.5")
Resolution	1440dpi x 5760dpi
Printing Speed	Iphone Case 12pcs one time, BI - directional Print 6 mins
Transmission Type	USB
Power Supply	AC 220V / 110V ± 10, 50Hz ~ 60Hz
Driver	Windows XP, WIN7 32bit
Machine Dimension	1000mm x 750mm x 520mm (39.3" x 29.5" x 20.4")
Machine Weight	154.3Ib (70kg)
<b>Price</b>	<b>≤ \$4,677</b>

### ▼ Samples



## &gt; Flatbed Printer &amp; Supplies

**FPS-JHUV-001 Series LED UV Ink (1000ml / bottle)**

**Available Colors:** Cyan, Magenta, Yellow, Black

LED UV ink is not required pre - treatment (pre - coat chemical) & can be printed on all print materials directly.

**Used for** DFP1800UV, A3+, A1 Size LED UV Inkjet flatbed printer and other Epson dx5 printhead LED UV Flatbed Printers

**Price:** ≤ \$173.55 / bottle

**FPS-JHUV-002: UV Cleaning Liquid (1000ml / bottle)**

LED UV ink is not required pre - treatment (pre - coat chemical) & can be printed on all print materials directly.

**Used for** A3+, A1 Size LED UV Inkjet flatbed printer and other Epson dx5 printhead LED UV Flatbed Printers

**Price:** ≤ \$100.83 / bottle

**FPS-JHUV-003: White UV Ink (1000ml / bottle)**

LED UV ink is not required pre - treatment (pre - coat chemical) & can be printed on all print materials directly.

**Used for** DFP1800UV, A3+, A1 Size LED UV Inkjet flatbed printer and other Epson dx5 printhead LED UV Flatbed Printers

**Price:** ≤ \$190.08 / bottle

**FPS-JHUV-004 Series 150ml LED UV Ink**

**Available Colors:** Cyan, Magenta, Yellow, Black

LED UV Ink (150ml / bottle)

LED UV ink is not required pre - treatment (pre - coat chemical) & can be printed on all print materials directly.

**Used for** DFP1800UV, A3+, A1 Size LED UV Inkjet flatbed printer and other Epson dx5 printhead LED UV Flatbed Printers

**Price:** ≤ \$39.67 / bottle

**FPS-JHUV-005: 150ml LED UV White Ink**

LED UV ink is not required pre - treatment (pre - coat chemical) & can be printed on all print materials directly.

**Used for** DFP1800UV, A3+, A1 Size LED UV Inkjet flatbed printer and other Epson dx5 printhead LED UV Flatbed Printers

**Price:** ≤ \$46.28 / bottle

**FPS-JHUV-006: 150ml Flatbed Printer Printhead Wetting Liquid**

Flatbed printer printhead Wetting Liquid (150ml / bottle)

**Used for** DFP1800UV, A3+, A1 Size LED UV Inkjet Flatbed Printer and other Epson dx5 printhead LED UV Flatbed Printers

**Price:** ≤ \$36.36 / bottle

**FPS-JHNC-001: Series DFP1800 Flatbed Printer Uncoating Ink**

**Available Colors:** Cyan, Magenta, Yellow, Black

1000ml / bottle

Uncoating ink is not required pre - treatment (pre - coat chemical) & can be printed on all print materials directly.

**Used for** DFP1800 Inkjet Flatbed Printer and other Epson dx5 printhead Flatbed Printers

**Price:** ≤ \$148.76 / bottle

**FPS-JHNC-002: Series DFP1800 Flatbed Printer Uncoating Ink**

**Available Colors:** Cyan, Magenta, Yellow, Black

150ml / bottle

Uncoating ink is not required pre - treatment (pre - coat chemical) & can be printed on all print materials directly.

**Used for** DFP1800 Inkjet Flatbed Printer and other Epson dx5 printhead Flatbed Printers

**Price:** ≤ \$34.38 / bottle

**FPS-JHNC-003: DFP1800 Flatbed Printer Uncoating Cleaning Liquid**

DFP1800 flatbed printer Uncoating Cleaning Liquid (1000ml / bottle)

**Used for** DFP1800 Inkjet Flatbed Printer and other Epson dx5 printhead Flatbed Printers

**Price:** ≤ \$82.64 / bottle

**FPS-JHNC-004: DFP1800 Flatbed Printer Uncoating Cleaning Liquid**

150ml / bottle

Uncoating ink is not required pre - treatment (pre - coat chemical) & can be printed on all print materials directly.

**Used for** DFP1800 Inkjet Flatbed Printer and other Epson dx5 printhead Flatbed Printers

**Price:** ≤ \$19.83 / bottle

## > Flag Making Machine

### Direct Dye Sublimation Printer / Heater (Flag Making Machine)

#### 1080 Flag making machine / Mut1600 Flag making machine

Direct dye sublimation heater, digital painting and scroll - making subdivision, all of them together are called Flag Making Machine.

The flag making system machine works with dye sublimation ink and fabrics. This system includes two units, the printer and the heater. The printer prints the image directly into the fabrics with the sublimation ink, and the heater, heats uniformly the prints until they become brilliant; there is no need of sublimated paper. Printing and dye sublimation is a continuous process, the machine prints and heats the flags to get a finish product in a faster way.

The advanced system adopts a balance front and back bar, as well as a textile dyeing technology, this machine can make all kinds of banners, portraits, mirror flags and more.

- This system of making flags includes the printer, heater and supplies (Dye sublimation ink and fabrics).
- 1080 (Flag making machine): Mutoh RJ900 printer, maximum media width: 1074mm (42").
- Mut1600 (Flag making machine): Mutoh 1604W printer, maximum media width: 1625mm (64").
- Unique pressure roller design.
- Steady in - phase balance weight system.
- Two ways of rotation direction for motor of fabric feeding system.
- Its products hang are convenient, soft, water proof, and anti - UV.
- This system has solved disadvantage of the mirror effect in conventional making flags.
- Used for textile dyeing directly without any interval media, it can make all kinds of banners for portray, mirror flags used indoor as well as outdoor.

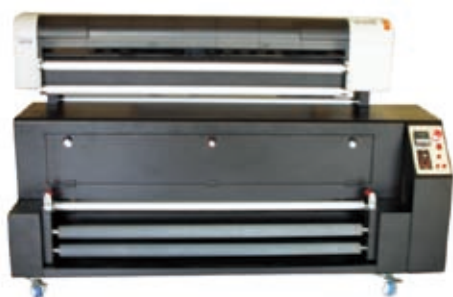

DDSH-SJX-CS1080



DDSH-SJX-CS1600

#### ▼ Specifications

Model	Working Size	Temperature	Voltage	Power	Machine Dimension	Machine Weight	Price
DDSH-SJX-CS1080	1074mm (42")	0 ~ 290°C	220V, 50 / 60Hz	2A / 16A	2000mm x 700mm x 650mm (79" x 27" x 26") / 2900mm x 1160mm x 1200mm (114" x 45" x 47")	510kg	≤ \$16,258
DDSH-SJX-CS1600	1625mm (64")	0 ~ 290°C	220V, 50 / 60 Hz	2A / 16A	2650mm x 1050mm x 850mm (104" x 41" x 33") / 3200mm x 1160mm x 1200mm (126" x 46" x 47")	660kg	≤ \$26,030

#### ▼ Samples



## &gt; Flag Making Machine

**Inkjet Textile Heater**

DDSH-SAER-SR1800 / DDSH-SAER-SR2500 / DDSH-SAER-SR3200

This sublimation system contains one printer (Roland, Mimaki, Mutoh, Epson and other printers you can choose), one heater and one filter fan equipment. It can reduce normal sublimation process, saving cost and time with high efficiency.

The printer prints the image directly into the fabrics with the sublimation ink, and the heater, heats uniformly the prints until they become brilliant; there is no need of sublimated paper. The printed textile can be inside and outside, is washable and there is no fading color.

But here we only go with the parameter of Inkjet Textile Heater.



- No need of any sublimation paper
- The printed textile can work both inside and outside, suitable for washing and no fading. To produce flags, color banner, curtain, and others.
- Maximum media width: 1800mm (71") / 2500mm (98") / 3200mm (126").
- Blackbody infrared radiation tube with electro thermal heating.
- Intelligent PID temperature control.
- Digital tension control.
- Controllable feeding speed and take up speed
- Controllable vacuum fan delivery.
- Quick tail gas treatment.
- Convenient to maintain.
- Easy to set up and operate.
- Easy to open the cover and clean the inside oven, easy to change the active carbon from the filter.
- Adopting the most advanced thermal energy technology, with low power consumption, saves electricity and conserve energy costs.

## ▼ Specifications

Model	Working Size	Temperature	Voltage	Power	Machine Dimension	Machine Weight	Price
DDSH-SAER-SR1800	1800mm (71")	100 ~ 300°C	220-240V, 50Hz	4.5KW	2380mm x 975 x 860mm (94" x 38" x 34")	390kg	≤ \$5,702
DDSH-SAER-SR2500	2500mm (98")	100 ~ 300°C	220-240V, 50Hz	4.5KW	3260mm x 975 x 860mm (128" x 38" x 34")	420kg	≤ \$10,361
DDSH-SAER-SR3200	3200mm (126")	100 ~ 300°C	220-240V, 50Hz	5.5KW	3960mm x 975 x 860mm (156" x 38" x 34")	510kg	≤ \$11,508

## ▼ Samples



## > Laminator & Finishing Equipments > Wide format roll laminator

### FMJ-1600-II-MULT: Full - auto MASTER MOUNTING COLD Laminator **TOP SALE**

Full-auto cold laminating machine (Automatic take - up roll for both printed images and back paper by one person), with functions of single sided cold laminating and mounting by electric.

Good color reducibility and light transmittance, free of bubbles and snowflake point!

A perfect fit for entry level customer, who is looking for an affordable and professional cold laminator for their projects.

This new model can be widely used for pre - masking vinyl graphic, mount prints on substrate, over laminating inkjet prints and so on.

- This machine is upgraded from FMJ-1600-II-PLUS, single side lifting roller, easy to adjust the open height of roller (the laminating thickness). Support roll to roll operation, which saves labor.
- It has simple structure, reasonable, humane and low cost characteristics.
- Adopt aluminum alloy supporting roller, which is easy to assemble and disassemble and can be used in exchange. The collecting rollers are dynamical rollers and the supporting rollers are without dynamic. All of the rollers are equipped with damp devices and are eligible for speed adjustment.
- The laminating - supporting roller and stripping roller are equipped with forelocks associating with standard 3 inches paper rolls.
- Since it was produced, it has been popular at the roller for supporting film, guiding roller and roller for collecting liner paper.
- It is operated conveniently and high efficiently - It realizes continuous laminating and longer picture laminating. Realize automatically stripping film and collecting liner paper through the rotary force of the upper and lower roller.



Film and liner separate



Control panel  
Single side lifting roller



#### ▼ Specifications

Model	FMJ-1600-II-MULT
Maximum Laminating Width	1600mm (63")
Maximum Laminating Thickness	35mm (1.38")
Laminating Speed	0 - 6m (236") / min
Forward / Reverse	Yes
Foot Pedal	Yes
Roller's Diameter	120mm (4.7")
Auto rewind liner pickup	Yes
After Laminating Pickup	Yes
Emergency Stops	Yes
Safety Photocell	Yes
Media Core Size	3"
Power Supply	AC80V - 110V, AC110V - 240V, 50Hz or 60Hz
Machine Weight	204kg
Machine Dimension	1938mm x 615mm x 1374mm (76" x 24" x 54")

**Price**

≤ \$1,445



Auto rewind liner pickup



After laminating pickup

## FMJ-1600-II-PLUS: Semi - auto MASTER MOUNTING COLD Laminator

Semi - auto cold laminating machine (Automatic take - up rolls of back paper), with functions of single sided cold laminating and mounting by electric. Good color reducibility and light transmittance, free of bubbles and snowflake point! It saves manpower and is easy to operate.

A perfect fit for entry level customer, who is looking for an affordable and professional cold laminator for their projects.

This new model can be widely used for pre - masking vinyl graphic, mount prints on substrate, over laminating inkjet prints and so on.

- FMJ-1600-II-PLUS is based on the theory of FMJ-1600-CIIZ, because we have the profound understanding of principle of laminator, the simple new laminator which is auto stripping and collecting back paper is developed.
- It has simple structure, reasonable, humane and low cost characteristics.
- Adopt new - style aluminum alloy supporting roller, which is easy to assemble and disassemble and can be used in exchange. The collecting rollers are dynamical rollers and the supporting rollers are without dynamic. All of the rollers are equipped with damp devices and are eligible for speed adjustment.
- The laminating - supporting roller and stripping roller are equipped with forelocks associating with standard 3 inches paper rolls.
- It saves manpower and is easy to operate. As a result of the novel structure it has been a good market since its appearance.
- Since it was produced, it has been popular at the roller for supporting film, guiding roller and roller for collecting liner paper.
- It is operated conveniently and high efficiently - It realizes continuous laminating and longer picture laminating. Realize automatically stripping film and collecting liner paper through the rotary force of the upper and lower roller.

### ▼ Specifications

Model	FMJ-1600-II-PLUS
Maximum Laminating Width	1600mm (63")
Maximum Laminating Thickness	25mm (1")
Laminating Speed	0 - 5m (197") / min
Forward / Reverse	Yes
Foot Pedal	Yes
Roller's Diameter	130mm (5")
Auto rewind liner pickup	Yes
After Laminating Pickup	No
Emergency Stops	Yes
Safety Photocell	Yes
Media Core Size	3"
Power Supply	AC80V - 110V, AC110V - 240V, 50Hz or 60Hz
Machine Weight	204kg
Machine Dimension	1785mm x 400mm x 1390mm (70" x 15.7" x 55")

**Price** ≤ \$1,285



Economical



Film and liner separate



Control panel

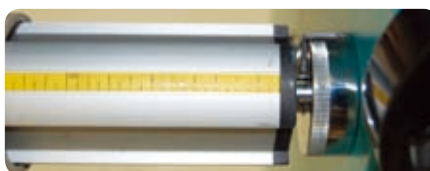

New type aluminium alloy supporting roller

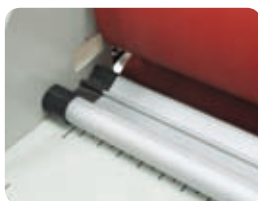

Panel for covering the picture



Photocell safety switch



The baffle - board of photocell safety switch



## > Laminator & Finishing Equipments > Wide format roll laminator

### FMJ-1600-RFZ-Y Full - auto HOT / COLD Laminator

Cabinet frame, all - metal casing shell, more stable working performance, **electrical pressurizing, LCD pressure display, raise roller up by electric.** Full - auto hot / cold laminating machine (Automatic take - up roll for both printed images and back paper by one person), with functions of single sided hot or cold laminating, low temperature cold laminating, mounting and encapsulating. High value - added products - Capable of running a wider range of media and can generate higher process speeds.

- High laminating efficiency, high - yield, long service life, low maintenance and labor costs.
- **Roll to Roll operation** - Taking up and rolling liner paper and picture automatically **by one person**. Reducing labor cost and improving quality!
- Good color reducibility and light transmittance, free of bubbles and snowflake point!
- 50 meters / roll film will not slant when working! Just about 8 mins to laminate one roll of 50 meters film!
- The weakness of bubble, snowflake point and bad coverage in traditional cold lamination could be avoided at temperature of 40 - 50 degree.
- High release silicone rollers, easy cleaning. Equipped with optical sensor and emergency stops for safety operation.
- Adopts new - style aluminum alloy supporting roller, which is easy to assemble / disassemble and can be used in exchange. The collecting rollers are dynamical rollers and the supporting rollers are without dynamic. All of the rollers are equipped with damp devices and are eligible for speed adjustment.



#### ▼ Specifications

Model	FMJ-1600-RFZ-Y
Maximum Laminating Width	1600mm (63")
Maximum Laminating Thickness	35mm (1.38")
Heated Roller	Top
Maximum Heating Temperature	150°C
Laminating Speed	0 - 7m (275") / min
Motor Forward / Reverse	Yes
Foot Pedal	Yes
Emergency Stops	Yes
Safety Photocell	Yes
Auto Rewind Liner Pickup	Yes
After Laminating Pickup	Yes
Roller's Diameter	120mm (4.7")
Media Core Size	3"
Motor Power	180W
Heating Power	3000W
Power Supply	AC80V - 240V / AC380V, 50 / 60Hz
Machine Weight	320kg
Machine Dimension	1980mm x 610mm x 1280mm (78" x 24" x 51")

**Price** ≤ \$3,997

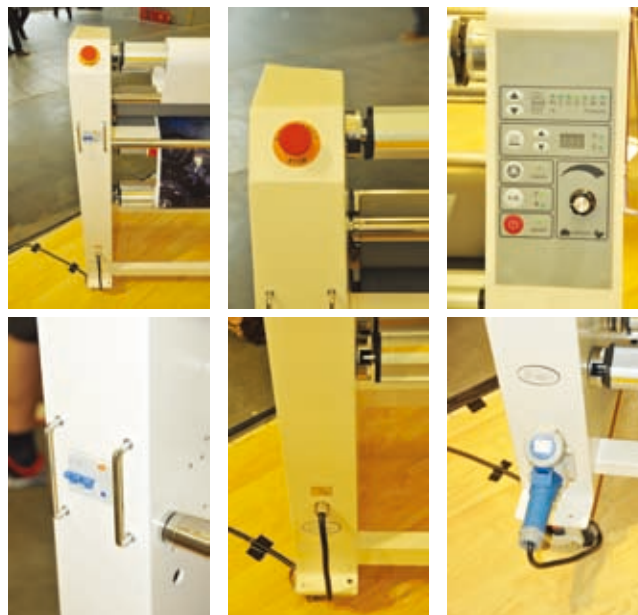

> Laminator & Finishing Equipments > Wide format roll laminator

### FMJ-1600-II-WARM: 63" Full - auto Wide Format Roll Low Temperature Cold Laminator

Full - auto cold laminator machine (Automatic take - up roll for both printed images and back paper by one person), with functions of single sided roll cold laminating and mounting by electric.

This machine is upgraded from FMJ-1600-II-MULT, adopts low temperature cold laminating, mainly used to solve the issue that cold laminated images are hazy.

Economic full - auto laminator, assembling stand, silicon roller, stable duration

Single side lifting roller, easy to adjust the open height of roller (the laminating thickness). Support roll to roll operation, which saves labor.

- Good color reducibility and light transmittance, free of bubbles and snowflake point!
- You can laminate 50m (164 feet) without shifting.
- This new model can be widely used for pre - masking vinyl graphic, mount prints on substrate, over laminating inkjet prints and so on.
- Solid built, laser - cut steel structure. Free heavy duty floor stand with caster wheels.
- 3" core auto - grip rollers for easy laminating film setup.
- 4.7" bigger up and down rollers for best quality laminating control.
- It has simple structure, reasonable, humane and low cost characteristics.
- Adopt aluminum alloy supporting roller, which is easy to assemble and disassemble and can be used in exchange. The collecting rollers are dynamical rollers and the supporting rollers are without dynamic. All of the rollers are equipped with damp devices and are eligible for speed adjustment.
- It is operated conveniently and high efficiently - It realizes continuous laminating and longer picture laminating. Realize automatically stripping film and collecting liner paper through the rotary force of the upper and lower roller.



#### ▼ Specifications

Model	FMJ-1600-II-WARM
Maximum Laminating Width	1600mm (63")
Maximum Laminating Thickness	35mm (1.38")
Heated Roller	Top
Maximum Heating Temperature	60°C
Laminating Speed	0 - 6m (236") / min
Motor Forward / Reverse	Yes
Foot Pedal	Yes
Emergency Stops	Yes
Safety Photocell	Yes
Auto Rewind Liner Pickup	Yes
After Laminating Pickup	Yes
Roller's Diameter	120mm (4.7")
Media Core Size	3"
Motor Power	90W
Heating Power	1500W
Power Supply	AC 80V - 240V / AC 380V, 50 / 60Hz
Machine Weight	220kg
Machine Dimension	1938mm x 615mm x 1374mm (76" x 24" x 54")
<b>Price</b>	<b>≤ \$1,815</b>



## &gt; Laminator &amp; Finishing Equipments &gt; Wide format roll laminator

**FMJ-1600-DM: 60" Economical Full - auto Low Temp Wide Format Cold Laminator**

Full - auto cold laminator machine (Automatic take - up rolls for both printed images and back paper by one person).

Adopts low temperature cold laminating, mainly used to solve the issue that cold laminated images are hazy. Driven by electric, including floor stand and foot pedal switch.

Adjust ISO quality 60W motor, stainless steel feeding table, 130mm (5") upper rubber roller, anti - tilt and anti - fold device (Origin) Pressure and height adjust hand wheel, Infrared temperature control device, multi - function footswitch

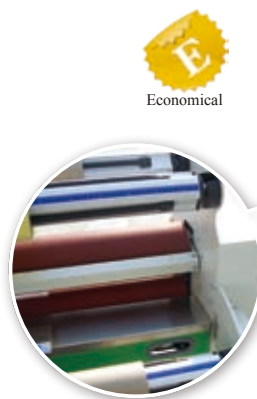

Economical



A whole volume prints will not go tilt due to anti - tilt system, greatly saves cost and improve productivity.

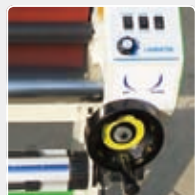

Upper roller raises up and down by a lifting link ensures even pressure.



Finished prints can be automatically onto the take - up roll.



Tension devices provide proper fraction and tension to prevent tilt and folds.



Thick stainless steel feeding table with round edge to avoid damage to prints during lamination.

## ▼ Specifications



Model	FMJ-1600-DM
Maximum Laminating Width	1520mm (60")
Maximum Laminating Thickness	23mm (1")
Heated Roller	Top
Maximum Heating Temperature	50°C
Laminating Speed	0 - 6m (236") / min
Motor Forward / Reverse	Yes
Foot Pedal	Yes
Emergency Stops	Yes
Safety Photocell	Yes
Auto Rewind Liner Pickup	Yes
After Laminating Pickup	Yes
Roller's Diameter	130mm (5")
Media Core Size	3"
Motor Power	60W
Heating Power	1400W
Power Supply	AC 80V - 240V / AC 380V, 50 / 60Hz
Machine Weight	140kg
Machine Dimension	74" x 27" x 45" (1880mm x 680mm x 1140mm)
<b>Price</b>	<b>≤ \$1,400</b>

## &gt; Laminator &amp; Finishing Equipments &gt; Wide format roll laminator

**FMJ-RFZX Series HOT / COLD Laminator** **HOT PRODUCT**

Full - auto hot / cold laminating machine (Automatic take - up roll for both printed images and back paper by one person), with functions of single sided hot or cold laminating, low temperature cold laminating, mounting and encapsulating.

Updated from FMJ-RFZ series stand frame hot laminator, it adopts cabinet frame, all - metal casing shell, more stable working performance. High value - added products - Capable of running a wider range of media and can generate higher process speeds.

- High laminating efficiency, high - yield, long service life, low maintenance and labor costs.
  - **Good color reducibility and light transmittance, free of bubbles and snowflake point!**
  - **50 meters / roll film will not slant when working! Just about 10 mins to laminate one roll of 50 meters film!**
  - **The weakness of bubble, snowflake point and bad coverage in traditional cold lamination could be avoided at temperature of 40 - 50 degree.**
  - High release silicone rollers, easy cleaning. Equipped with optical sensor and emergency stops for safety operation.
  - Adopts new - style aluminum alloy supporting roller, which is easy to assemble / disassemble and can be used in exchange. The collecting rollers are dynamical rollers and the supporting rollers are without dynamic.
- All of the rollers are equipped with damp devices and are eligible for speed adjustment.

**Laminating process**

Cold laminating

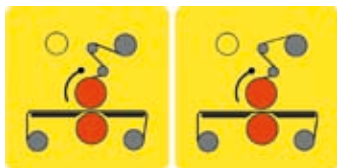

Hot laminating



FMJ-1600-RFZ



FMJ-1600-RFZX

**▼ Specifications**

Model	FMJ-1100-RFZX	FMJ-1300-RFZX	FMJ-1600-RFZX	FMJ-1700-RFZX	FMJ-2050-RFZX	FMJ-2300-RFZX
Maximum Laminating Width	1100mm (43")	1300mm (51")	1600mm (63")	1700mm (67")	2050mm (81")	2300mm (90")
Maximum Laminating Thickness	25mm (1")	25mm (1")	25mm (1")	25mm (1")	25mm (1")	25mm (1")
Heated Roller	Top	Top	Top	Top	Top	Top
Maximum Heating Temperature	150°C	150°C	150°C	150°C	150°C	150°C
Laminating Speed	0-5m (197") / min	0-5m (197") / min	0-5m (197") / min	0-5m (197") / min	0-5m (197") / min	0-5m (197") / min
Motor Forward / Reverse	Yes	Yes	Yes	Yes	Yes	Yes
Foot Pedal	Yes	Yes	Yes	Yes	Yes	Yes
Emergency Stops	Yes	Yes	Yes	Yes	Yes	Yes
Safety Photocell	Yes	Yes	Yes	Yes	Yes	Yes
Auto Rewind Liner Pickup	Yes	Yes	Yes	Yes	Yes	Yes
After Laminating Pickup	Yes	Yes	Yes	Yes	Yes	Yes
Roller's Diameter	130mm (5")	130mm (5")	130mm (5")	155mm (6")	155mm (6")	155mm (6")
Media Core Size	3"	3"	3"	3"	3"	3"
Power Supply	The voltage is up to the local requirement, like AC80V - 110V / AC110V - 240V / AC380V, 50 / 60Hz					
Machine Weight	250kg	290kg	320kg	380kg	480kg	530kg
Machine Dimension	1480mm x 610mm x 1280mm (58" x 24" x 51")	1680mm x 610mm x 1280mm (66" x 24" x 51")	1980mm x 610mm x 1280mm (78" x 24" x 51")	2080mm x 610mm x 1280mm (82" x 24" x 51")	2420mm x 640mm x 1280mm (95" x 25" x 51")	2680mm x 650mm x 1300mm (106" x 26" x 51")
<b>Price</b>	≤ \$3,329	≤ \$3,515	≤ \$3,702	≤ \$4,075	≤ \$5,679	≤ \$7,575

## > Laminator & Finishing Equipments > Wide format roll laminator

### FMJ-ZJX Series COLD Laminator **HOT PRODUCT**

Full - auto cold laminating machine (Automatic take - up roll for both printed images and back paper by one person), with functions of single sided cold laminating or mounting

Updated from FMJ-ZJ series stand frame cold laminator, it adopts cabinet frame, all - metal casing shell, more stable working performance. Reducing labor cost and improving quality! High value - added products - Capable of running a wider range of media and can generate higher process speeds.

- High laminating efficiency, high - yield, long service life, low maintenance and labor costs.
- **Good color reducibility and light transmittance, free of bubbles and snowflake point!**
- **50 meters / roll film will not slant when working! Just about 10 mins to laminate one roll of 50 meters film!**
- **Equipped with optical sensor and emergency stops for safety operation.**
- Adopts new - style aluminum alloy supporting roller, which is easy to assemble and disassemble and can be used in exchange.
- The collecting rollers are dynamical rollers and the supporting rollers are without dynamic.
- All of the rollers are equipped with damp devices and are eligible for speed adjustment.

#### Laminating process



Cold laminating

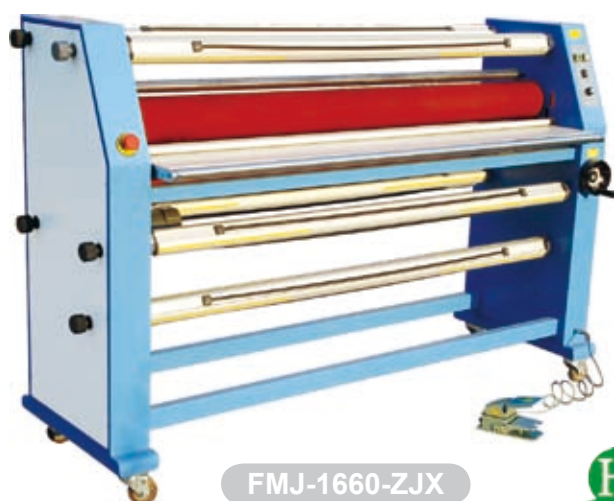

FMJ-1660-ZJX



High-quality



FMJ-1660-ZJ

#### ▼ Specifications

Model	FMJ-1100-ZJX	FMJ-1400-ZJX	FMJ-1660-ZJX	FMJ-1700-ZJX	FMJ-2050-ZJX	FMJ-2300-ZJX
Maximum Laminating Width	1100mm (43")	1400mm (55")	1660mm (65")	1700mm (67")	2050mm (81")	2300mm (90")
Maximum Laminating Thickness	25mm (1")	25mm (1")	25mm (1")	25mm (1")	25mm (1")	25mm (1")
Laminating Speed	0-5m (197") / min	0-5m (197") / min	0-5m (197") / min	0-5m (197") / min	0-5m (197") / min	0-5m (197") / min
Motor Forward / Reverse	Yes	Yes	Yes	Yes	Yes	Yes
Foot Pedal	Yes	Yes	Yes	Yes	Yes	Yes
Emergency Stops	Yes	Yes	Yes	Yes	Yes	Yes
Safety Photocell	Yes	Yes	Yes	Yes	Yes	Yes
Auto Rewind Liner Pickup	Yes	Yes	Yes	Yes	Yes	Yes
After Laminating Pickup	Yes	Yes	Yes	Yes	Yes	Yes
Roller's Diameter	130mm (5")	130mm (5")	130mm (5")	130mm (5")	155mm (6")	155mm (6")
Media Core Size	3"	3"	3"	3"	3"	3"
Power	The voltage is up to the local requirement, like AC80V - 110V / AC110V - 240V, AC380V, 50 / 60Hz					
Machine Weight	220kg	260kg	290kg	310kg	410kg	500kg
Machine Dimension	1480mm x 610mm x 1280mm (58" x 24" x 51")	1780mm x 610mm x 1280mm (70" x 24" x 51")	1980mm x 610mm x 1280mm (78" x 24" x 51")	2080mm x 610mm x 1280mm (82" x 24" x 51")	2420mm x 640mm x 1220mm (95" x 25" x 48")	2680mm x 650mm x 1300mm (106" x 26" x 51")
<b>Price</b>	≤ \$2,582	≤ \$2,956	≤ \$3,329	≤ \$3,702	≤ \$4,747	≤ \$6,612



**FMJ-RFZS Series HOT / COLD Laminator    HOT PRODUCT****Cabinet Frame Full - auto Self - peeling and Dual Rollers Heated Model****Full - auto hot / cold laminating machine (Automatic take - up roll for both printed images and back paper by one person)****Cabinet Frame, all - metal casing shell, more stable working performance****Dual heat rollers and temperature controllers, which can control temperature respectively****High value - added products - Capable of running a wider range of media and can generate higher process speeds.****Laminating procedures:** double or single sided hot laminating, single or double sides cold laminating, low temperature cold laminating, mounting and encapsulating.

- High laminating efficiency, high - yield, long service life, low maintenance and labor costs.
- Good color reducibility and light transmittance, free of bubbles and snowflake point!
- 50 meters / roll film will not slant when working! Just about 10 mins to laminate one roll of 50 meters film!
- The weakness of bubble, snowflake point and bad coverage in traditional cold lamination could be avoided at temperature of 40 - 50 degree.
- High release silicone rollers - for easy cleaning. Equipped with optical sensor and emergency stops for safety operation.
- Adopts new - style aluminum alloy supporting roller, which is easy to assemble and disassemble and can be used in exchange. The collecting rollers are dynamical rollers and the supporting rollers are without dynamic. All of the rollers are equipped with damp devices and are eligible for speed adjustment.
- The laminating - supporting roller and stripping roller are equipped with forelocks associating with standard 3 inches paper rolls.

**FMJ-1600-RFZS**
  
High-quality
**▼ Specifications**

Model	FMJ-1100-RFZS	FMJ-1300-RFZS	FMJ-1600-RFZS	FMJ-1700-RFZS	FMJ-2050-RFZS	FMJ-2300-RFZS
Maximum Laminating Width	1100mm (43")	1300mm (51")	1600mm (63")	1700mm (67")	2050mm (81")	2300mm (90")
Maximum Laminating Thickness	25mm (1")	25mm (1")	25mm (1")	25mm (1")	25mm (1")	25mm (1")
Heated Roller	Top and bottom	Top and bottom	Top and bottom	Top and bottom	Top and bottom	Top and bottom
Maximum Heating Temperature	150°C	150°C	150°C	150°C	150°C	150°C
Laminating Speed	0-5m (197") / min	0-5m (197") / min	0-5m (197") / min	0-5m (197") / min	0-5m (197") / min	0-5m (197") / min
Forward / Reverse	Yes	Yes	Yes	Yes	Yes	Yes
Foot Pedal	Yes	Yes	Yes	Yes	Yes	Yes
Emergency Stops	Yes	Yes	Yes	Yes	Yes	Yes
Safety Photocell	Yes	Yes	Yes	Yes	Yes	Yes
Auto Rewind Liner Pickup	Yes	Yes	Yes	Yes	Yes	Yes
After Laminating Pickup	Yes	Yes	Yes	Yes	Yes	Yes
Roller's Diameter	130mm (5")	130mm (5")	130mm (5")	155mm (6")	155mm (6")	155mm (6")
Media Core Size	3"	3"	3"	3"	3"	3"
Power	The voltage is up to the local requirement, like AC80V - 110V / AC110V - 240V / AC380V, 50 / 60Hz					
Machine Weight	240kg	275kg	360kg	390kg	490kg	550kg
Machine Dimension	1480mm x 610mm x 1280mm (58" x 24" x 51")	1680mm x 610mm x 1280mm (66" x 24" x 51")	1980mm x 610mm x 1280mm (78" x 24" x 51")	2080mm x 610mm x 1280mm (82" x 24" x 51")	2380mm x 610mm x 1280mm (94" x 24" x 51")	2680mm x 650mm x 1300mm (106" x 26" x 51")
<b>Price</b>	≤ \$3,709	≤ \$3,888	≤ \$4,075	≤ \$4,448	≤ \$6,662	≤ \$8,478



**FMJ-ZD Series HOT / COLD Laminator UPGRADE PRODUCT**

**Full - auto hot / cold laminating machine (Automatic take - up roll for both printed images and back paper by one person)**

**Laminating Procedures Includes:** double or single sided hot laminating, single or double sided cold laminating, low temperature cold laminating, mounting and encapsulating

**Cabinet Frame, all - metal casing shell, more stable working performance, with paper cutter device and laminating counter**

The FMJ-ZD series laminator is dual roller HOT laminator, capable of running a wider range of media and can generate higher process speeds, which make this range of machines ideal for business that is looking to build in extra capacity and more versatility.



FMJ-1600-ZD



- **Roll to Roll operation** - Taking up and rolling liner paper and picture automatically **by one person**. Reducing labor cost and improving quality!
- Good color reducibility and light transmittance, free of bubbles and snowflake point!
- 50 meters / roll film will not slant when working! Just about 10 mins to laminate one roll of 50 meters film!
- In most cases, cold laminating doesn't require the roller to be heated, yet the quality of the laminating could be enhanced if the upper roller is heated to 40 - 50 degree.
- Adopt new - style aluminum alloy supporting roller, which is easy to assemble and disassemble and can be used in exchange. The collecting rollers are dynamical rollers and the supporting rollers are without dynamic. All of the rollers are equipped with damp devices and are eligible for speed adjustment.
- The laminating - supporting roller and stripping roller are equipped with forelocks associating with standard 3 inches paper rolls.
- High release silicone rollers - for easy cleaning. Equipped with optical sensor and emergency stops for safety operation.

**▼ Specifications**

Model	FMJ-1100-ZD	FMJ-1300-ZD	FMJ-1600-ZD	FMJ-2050-ZD
Maximum Laminating Width	1100mm (43")	1300mm (51")	1600mm (63")	2050mm (81")
Maximum Laminating Thickness	25mm (1")	25mm (1")	25mm (1")	25mm (1")
Heated Roller	Top	Top	Top	Top
Maximum Heating Temperature	150°C	150°C	150°C	150°C
Laminating Speed	0 - 5m (197") / min	0 - 5m (197") / min	0 - 5m (197") / min	0 - 5m (197") / min
Motor Forward / Reverse	Yes	Yes	Yes	Yes
Foot Pedal	Yes	Yes	Yes	Yes
Emergency Stops	Yes	Yes	Yes	Yes
Safety Photocell	Yes	Yes	Yes	Yes
Auto Rewind Liner Pickup	Yes	Yes	Yes	Yes
After Laminating Pickup	Yes	Yes	Yes	Yes
Roller's Diameter	130mm (5")	130mm (5")	130mm (5")	155mm (6")
Media Core Size	3"	3"	3"	3"
Power Supply	The voltage is up to the local requirement, like AC80V - 110V, AC110V - 240V, AC380V; The current is 50 / 60Hz			
Machine Weight	360kg	390kg	420kg	485kg
Machine Dimension	1450mm x 650mm x 1350mm (57" x 26" x 53")	1650mm x 650mm x 1350mm (65" x 26" x 53")	1985mm x 740mm x 1350mm (78" x 29" x 53")	2400mm x 740mm x 1400mm (94" x 29" x 53")

**Price**

≤ \$4,672

≤ \$5,131

≤ \$7,120

≤ \$11,739

> Laminator & Finishing Equipments > Wide format roll laminator

**FMJ-RS Series SINGLE SIDE HOT Laminator**



FMJ-1140-RS



FMJ-650-RS

Single sided hot laminating, single sided cold laminating, mounting and encapsulating. With LED monitor, all - metal casing, 2 pcs of high temperature silicone roller.

- Easy to transport and operate.
- Speed and temperature adjustable
- Electric model, stepless speed regulating, foot pedal switch for hands free operation.
- High release silicone rollers - for easy cleaning.

▼ Specifications

Model	FMJ-650-RS	FMJ-1140-RS
Maximum Laminator Width	635mm (25")	1100mm (43")
Roller's Diameter	96mm (3.8")	102mm (4")
Maximum Laminating Thickness	5.5mm (0.2")	5.5mm (0.2")
Maximum Heating Temperature	150 degree	150 degree
Laminating Speed	From 0 to 3m (118") / min	From 0 to 4m (157") / min
Foot Pedal	Yes	Yes
Forward / Reverse	Yes	Yes
Floor Stand	Optional	Include
Auto Rewind Liner Pickup	No	No
After Laminating Pickup	No	No
Emergency Stops	No	No
Safety Photocell	No	No
Machine Color	Red or black	Red or black
Power Supply	The voltage is up to the local requirement, like AC80V - 110V, AC110V - 240V, 50 / 60Hz	
Machine Weight	42kg	135kg
Machine Dimension	930mm x 430mm x 290mm (36.6" x 17" x 11.4")	1350mm x 450mm x 1280mm (53" x 218" x 50")
<b>Price</b>	≤ \$839	≤ \$1,606

**FMJ-RD Series DOUBLE SIDES HOT Laminator**

With functions of double sided hot laminating, single sided hot laminating, single sided cold laminating, cold and hot mounting and encapsulating.

With LED monitor, all - metal casing shell, 4pcs of high temperature silicone roller, the top and bottom roller can be heated up respectively. Easy to transport and operate.

- Electric model, stepless speed regulating, foot pedal switch for hands free operation.
- High release silicone rollers - for easy cleaning.
- Easy operation, speed and temperature adjustable.

▼ Specifications

Model	FMJ-360-RD	FMJ-650-RD
Maximum Laminator Width	340mm (13")	620mm (24")
Roller's Diameter	45mm (1.8")	60mm (2.4")
Maximum Laminating Thickness	5mm (0.2")	5mm (0.2")
Maximum Heat Temperature	150 degree	150 degree
Laminating Speed	From 0 to 3m (118") / min	From 0 to 3m (118") / min
Foot Pedal	Yes	Yes
Forward / Reverse	Yes	Yes
Floor Stand	Optional	Optional
Auto Rewind Liner Pickup	No	No
After Laminating Pickup	No	No
Emergency Stops	No	No
Safety Photocell	No	No
Power	110 - 220V, 50 / 60Hz. 3A	110 - 220V, 50 / 60Hz. 3A
Machine Weight	30kg	50kg
Machine Dimension	600mm x 430mm x 280mm (23.6" x 17" x 11")	930mm x 430mm x 290mm (36.6" x 17" x 11.4")
<b>Price</b>	≤ \$632	≤ \$1,621

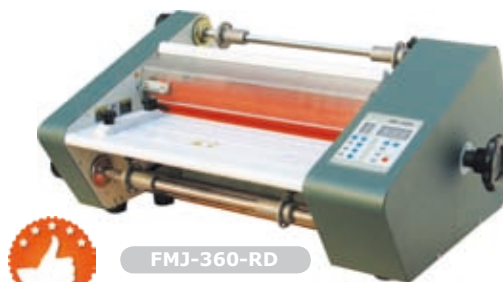

FMJ-360-RD



FMJ-650-RD



## > Laminator & Finishing Equipments > Wide format roll laminator

### FMJ-RFX Series Semi - auto LOW TEMP. COLD Laminator

Adopts low temperature cold laminating, mainly used to solve the issue that cold laminated images are hazy

Stand frame construction, automatic take - up rolls of back paper.

Driven by electric, including floor stand and foot pedal switch

- Adopts new - style aluminum alloy supporting roller, which is easy to assemble and disassemble and can be used in exchange. The collecting rollers are dynamical rollers and the supporting rollers are without dynamic. All of the rollers are equipped with damp devices and are eligible for speed adjustment.
- The laminating - supporting roller and stripping roller are equipped with forelocks associating with standard 3 inches paper rolls.
- Electric model, stepless speed regulating.
- It comes with foot pedal with forward and reverse control to free your hands from handling the work being processed.
- High release silicone rollers - for easy cleaning.



FMJ-1600-RFX

#### ▼ Specifications

Model	FMJ-1600-RFX
Maximum Laminator Width	1600mm (63")
Roller's Diameter	102mm (4")
Maximum Laminating Thickness	10mm (0.4")
Maximum Heating Temperature	60 degree
Laminating Speed	From 0 to 4m (157") / min
Foot Pedal	Yes
Motor Forward / Reverse	Yes
Floor Stand	Yes
Auto Rewind Liner Pickup	Yes
After Laminating Pickup	No
Emergency Stops	No
Safety Photocell	No
Power Supply	AC80V - 240V, AC380V, 50 / 60Hz
Machine Color	Red or black
Machine Weight	140kg
Machine Dimension	1900mm x 460mm x 1030mm (75" x 18" x 41")
<b>Price</b>	<b>≤ \$2,394</b>



### FMJ-650-II: 650mm (26") Desktop MASTER MOUNTING Cold Laminator

Table Top Model, driven by electric or by hand (For option)

No need to heat, no auto rewind shafts

- The mounting master 26" is motorized table top laminators. Simple structure, portable machine.
- It comes with foot pedal with forward and reverse control to free your hands from handling the work being processed.
- The easy speed control makes your daily job more handily; Laminating speed can be easily adjusted from 0 to 3m (118") / min.
- This model is designed for mounting and laminating inkjet prints, but is equally capable of handling photographic or any printed media.

#### ▼ Specifications

Model	FMJ-650-II	FMJ-650-II plus
Maximum Laminator Width	650mm (26")	650mm (26")
Roller's Diameter	65mm (2.6")	65mm (2.6")
Maximum Laminating Thickness	10mm (0.4")	10mm (0.4")
Laminating Speed	From 0 to 3m (118") / min	From 0 to 3m (118") / min
Foot Pedal	Yes	Yes
Forward / Reverse	Yes	Yes
Auto Rewind Shafts	No	Yes
Power	110V / 220V, 50 / 60Hz. 3A	110V / 220V, 50 / 60Hz. 3A
Machine Weight	26kg	29.4kg
Machine Dimension	850mm x 360mm x 370mm (33" x 14" x 15")	860mm x 360mm x 370mm (34" x 14" x 15")
<b>Price</b>	<b>≤ \$249</b>	<b>≤ \$396</b>



FMJ-650-II



FMJ-650-II plus

FMJ-650-II plus is upgraded from FMJ-650-II, it has all functional characteristics of FMJ-650-II, and comes with support shaft for manually rewinding the backing paper in some projects.

## FMJ-FM (C) Series FLATBED COLD Laminator

FMJ-FM series machines: Simple electric cold laminator.

FMJ-FMC series machines: Pneumatic controlled operation saves energy and is convenient. Can be used as low temperature cold laminator.

Maximum laminating thickness can be up to 45mm (1.8").

Specially used for wooden board or glass, include floor stand.

A perfect fit for laminating flatbed material.

- Available for laminating wooden board or glass to avoid surface scraping during transportation.
- The front and rear working table make the flatbed board or glass go stably and safely.
- Two rollers (Front also rear) are driven by motor and take another two free rollers going in - phase, which make the flatbed mounting job more mechanical, more efficient.



FMJ-1300-FMC



FMJ-1600-FM

### ▼ Specifications



Model	FMJ-1300-FM	FMJ-1600-FM	FMJ-2040-FM
Maximum Laminating Width	1300mm (51")	1600mm (63")	2040mm (80")
Maximum Laminating Thickness	25mm (1")	25mm (1")	25mm (1")
Laminating Speed	0 - 5m (197") / min	0 - 5m (197") / min	0 - 5m (197") / min
Foot Pedal	Yes	Yes	Yes
Emergency Stops	Yes	Yes	Yes
Roller's Diameter	90mm (3.5")	130mm (5")	155mm (6")
Power		AC80V - 240V, AC380V, 50 / 60Hz	
Machine Weight	260kg	280kg	300kg
Machine Dimension	1470mm x 1300mm x 1120mm (58" x 51" x 44")	1780mm x 1300mm x 1120mm (70" x 51" x 44")	2200mm x 1420mm x 1120mm (87" x 56" x 44")
<b>Price</b>	<b>≤ \$2,985</b>	<b>≤ \$3,399</b>	<b>≤ \$4,850</b>

### ▼ Specifications



Model	FMJ-1300-FMC	FMJ-1600-FMC
Maximum Laminating Width	1260mm (50")	1560mm (61")
Maximum Laminating Thickness	45mm (1.8")	45mm (1.8")
Heated Roller	Top	Top
Max. Heating Temperature	100°C	100°C
Laminating Speed	0 - 8m (315") / min	0 - 8m (315") / min
Forward / Reverse	Yes	Yes
Heating Power	2.5KW Single roller	2.5KW Single roller
Motor Power	90W	90W
Foot Pedal	Yes	Yes
Emergency Stop	Yes	Yes
Auto Rewind Liner Pickup	Yes	Yes
Roller's Diameter	122mm (4.8")	130mm (5")
Media Core Size	3"	3"
Machine Weight	290kg	320kg
Machine Dimension	1470mm x 1300mm x 1120mm (58" x 51" x 44")	1780mm x 1300mm x 1120mm (70" x 51" x 44")
<b>Price</b>	<b>≤ \$5,500</b>	<b>≤ \$6,672</b>

> Laminator & Finishing Equipments > Wide format roll laminator



FMJ-1600-C

**FMJ Simple MANUAL COLD Laminator**

No need to heat, no motor driving, and no auto rewind shafts. It is easy to support picture with front / back mandrel holder.

- Easy operation, simple structure.
- This model is designed for mounting and laminating inkjet prints, it is equally capable of handling photographic or any printed media.



FMJ-650



▼ Specifications

Model	FMJ-650	FMJ-1600-C	FMJ-1700
Maximum Laminating Width	650mm (26")	1600mm (63")	1700mm (67")
Maximum Laminating Thickness	10mm (0.4")	25mm (1")	25mm (1")
Laminating Speed	Up to the operator	Up to the operator	Up to the operator
Roller's Diameter	65mm (2.6")	130mm (5")	155mm (6")
Floor Stand	No	Include	Include
Machine Weight	24kg	193kg	210kg
Machine Dimension	760mm x 280mm x 230mm (30" x 11" x 9")	1780mm x 600mm x 800mm (70" x 24" x 35")	1900mm x 600mm x 920mm (75" x 24" x 36")
Price	≤ \$203	≤ \$907	≤ \$1,295

**FMJ-II Series ELECTRIC COLD Laminator**

Driven by electric or manual (for option)  
 No auto rewind shafts, no need to heat, include stand  
 This model has a price that fits your budget and guarantees a quality result

- Electric operation. The speed control makes your daily job easier.
- It comes with foot pedal with forward and reverse control to free your both hands from handling the work being processed.
- This unit is great for mounting to boards, applying application tapes, applying double side, adhesives and vinyl, save time and no hassles.
- Reasonable design, it is easy to support picture with front / back mandrel holder.



FMJ-1300-II



FMJ-1600-CII



▼ Specifications

Model	FMJ-1000-II	FMJ-1300-II	FMJ-1600-CII	FMJ-1700-II	FMJ-2040-II
Maximum Laminating Width	1000mm (40")	1300mm (51")	1600mm (63")	1700mm (67")	2040mm (80")
Maximum Laminating Thickness	15mm (0.6")	15mm (0.6")	25mm (1")	25mm (1")	25mm (1")
Laminating Speed	0 - 5m (197") / min	0 - 5m (197") / min	0 - 5m (197") / min	0 - 5m (197") / min	0 - 5m (197") / min
Motor Forward / Reverse	Yes	Yes	Yes	Yes	Yes
Foot Pedal	Yes	Yes	Yes	Yes	Yes
Roller's Diameter	90mm (3.5")	90mm (3.5")	130mm (5")	155mm (6")	155mm (6")
Auto rewind liner pickup	No	No	No	No	No
After Laminating Pickup	No	No	No	No	No
Emergency Stops	Yes	Yes	Yes	Yes	Yes
Safety Photocell	Yes	Yes	Yes	Yes	Yes
Media Core Size	3"	3"	3"	3"	3"
Power	AC80V - 110V, AC110V - 240V, 50 / 60Hz				
Machine Weight	87kg	90kg	196kg	206kg	250kg
Machine Dimension	1160mm x 520mm x 850mm (46" x 20" x 33")	1420mm x 600mm x 995mm (60" x 24" x 39")	1830mm x 650mm x 910mm (72" x 26" x 36")	1900mm x 650mm x 950mm (75" x 26" x 37")	2250mm x 650mm x 950mm (88" x 26" x 37")
Price	≤ \$674	≤ \$736	≤ \$1,067	≤ \$1,471	≤ \$1,741

> Laminator & Finishing Equipments > Liquid laminator

### FMJ-WL Series Full - auto Liquid Laminator

Support Roll to Roll Operation, full - auto (Automatic take - up roll for both printed images and back paper by one person)

Mainly used for roll to roll coating of vinyl, banner, canvas, etc.

Compatible with most roll - to - roll solvent, ECO - solvent inkjet printers.

It is widely used in the post - production of outside / inside advertisement and vehicle body advertisement.

- After laminating, the media can be crack resist, more flexible, UV protection, scratch resist, etc.
- Has both flash drying system and cooling system, which make the coating film from liquid state to solid state, especially for hard - to - dry inks.
- Easy operation panel: Dryer, fan, motor, pump button
  - Various speed and temperature adjustment
  - Temperature indication
  - Emergency Stop Button
- The liquid laminator is cost - effective and environmentally friendly.
  - Coating costs range from \$0.25 to \$0.32 per sq. m.
  - Easy to operate and clean, requires minimal operator training.

**Mayer bar Specification** (Liquid film is formed on the picture surface directly, and the film thickness is up to the size of Mayer bar. You can change the Mayer bar to increase film thickness according to requirement.)

Wire Diameter	Coating Thickness
0.5mm	8mic
0.8mm	10mic
1.0mm	15mic
1.2mm	20mic



Mayerbar



Applicable to the body covered paste



FMJ-1600-WL

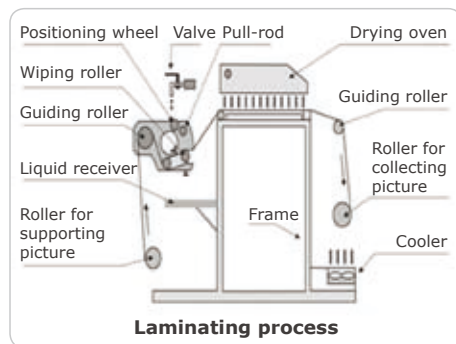

Liquid film tube



Liquid film tank

▼ Specifications

Model	FMJ-1600-WL	FMJ-2200-WL
Maximum Coating Width	1560mm (61")	2100mm (83")
Maximum Laminating Thickness	0.007 - 0.01mm	0.007 - 0.01mm
Maximum Laminating Speed	1 - 1.5m (40" - 59") / min	1 - 1.5m (40" - 59") / min
Laminating Temperature	100 - 130 degree	100 - 130 degree
Maximum Heating Temperature	150 degree	150 degree
Forward / Reverse	Yes	Yes
Emergency Stops	Yes	Yes
After Laminating Pickup	Yes	Yes
Power Supply	The voltage is up to the local requirement, like AC110V - 240V / AC380V, 50Hz / 60Hz	
Machine Weight	350kg	480kg
Machine Dimension	2025mm x 930mm x 1050mm (80" x 37" x 41")	3810mm x 1100mm x 1084mm (150" x 43" x 42")
<b>Price</b>	<b>≤ \$7,053</b>	<b>≤ \$8,579</b>



## FMJ-3300-WL: Super Large Format Liquid Laminator

Support Roll to Roll Operation, full - auto (Automatic take - up roll for both printed images and back paper by one person)  
FMJ-3300-WL liquid laminating width can reach 3.2 meters, mainly used for **Roll to Roll** coating of vinyl, banner, canvas, etc.  
Especially fit for the wide - breadth advertisement picture.

**Due to the price of liquid film is lower than cold laminating film, this make output rate is very high. Using liquid laminator can reduce the film laminating cost much more than ever before. You can get back your investment in a short time.**

### ▼ Products Highlights:

- This liquid laminator has both drying system and cooling system, which make the coating film from liquid state to solid state. After laminating, the media can be crack resist, more flexible, UV protection, scratch resist etc.
- Easy operation panel: Dryer, fan, motor, pump button. Various speed and temperature adjustment. Temperature indication. Emergency Stop Button.
- In order to **save energy**, you may use right part of the heating box to reduce the power (50%) when the picture width is less than 1.6 meters.
- **Works simply and safely with low noise.** It uses liquid water - soluble film, which is innocuous and flavorless, also be clean out without pollution. It is good for protecting environment very well.
- Has **both flash drying system and cooling system**, which make the coating film from liquid state to solid state, especially for hard - to - dry inks.
- The liquid laminator reduce the laminating cost and be good for environment. Coating costs range from \$0.25 to \$0.32 per sq.m, depending on application and coating used.
- Easy to operate and clean, requires minimal operator training.

Wire Diameter	Coating Thickness
0.5mm	8mic
0.8mm	10mic
1.0mm	15mic
1.2mm	20mic

**Mayer bar Specification** (Liquid film is formed on the picture surface directly, and the film thickness is up to the size of Mayer bar. You can change the Mayer bar to increase film thickness according to requirement.)

### Laminating process

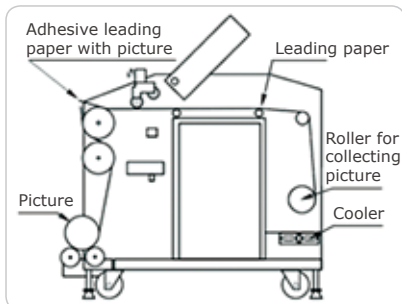
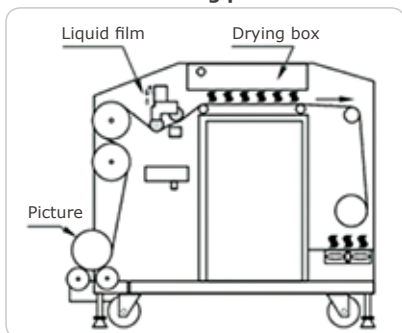

For the structure and mode of materials covered outdoor inkjet printer



Packing

### ▼ Specifications

Model	FMJ-3300-WL
Maximum Coating Width	3200mm (126")
Maximum Laminating Thickness	0.007 - 0.01mm
Maximum Laminating Speed	1 - 1.5m (40" - 59") / min
Laminating Temperature	100 - 130 degree
Maximum Heating Temperature	150 degree
Forward / Reverse	Yes
Emergency Stops	Yes
After Laminating Pickup	Yes
Power Supply	AC380V, 50Hz or 60Hz
Machine Weight	750kg
Machine Dimension	3810mm x 1100mm x 1084mm (150" x 43" x 42")
<b>Price</b>	<b>≤ \$17,866</b>



## CS-3000S-906: Luxurious HF Welder for Flex Banner

Be used for advertising materials welding, such as flex banner, housetop tarpaulin, swimming pool for PVC membrane, banner, etc.

- Delicate outer appearance, remote operation
- Reasonable and improved mechanical structure
- High speed, optional table length
- Smooth and perfect output
- Power saving and time saving

For the operating table, the improved rail materials enable the whole structure a better stability.

The air compressor, voltage stabilizer and controller are all fixed into one solid unit so that the operation becomes much more safe and convenient.

The working table could be larger and 3m is one unit, but the standard working table is 6m and could be enlarged to 9m, 12m, 15m, etc.



### ▼ Details



### ▼ Samples



### ▼ Specifications

Model	CS-3000S-906
Table Length	6000mm (236") (Standard)
Welding Table	3180mm x 960mm x 800mm (125" x 38" x 31")
Floor Requirement	7.8sqm
Welding Width	10mm - 40mm (0.4" - 1.6")
Welding Speed	1000mm - 6000mm / min (39" - 236")
Rated Voltage	Single Phase 50Hz, AC 220V ± 10%
Power	3000W
Frequency	27.12 ± 0.5% MHz
Working Pressure	2 - 4kg
Air Requirement	6 bar
<b>Price</b>	<b>≤ \$31,570</b>



## CS-3000S: Continuous HF Welder for Banner & Tarpaulin



Be used for advertising materials welding, such as flex banner, housetop tarpaulin, swimming pool for PVC membrane, and banner, etc.

- Space saving, also more durable
- High speed, optional table length
- Smooth and perfect output
- Power saving, labor saving and time saving
- Adopting a unique continuous HF welding theory
- Optimizing in mechanical design

A bigger welding head pressure obtained in this machine, labor saving & time saving

The working table could be larger and 3m is one unit, but the standard working table is 6m and could be enlarged to 9m, 12m, 15m, etc.

### ▼ Samples



### ▼ Specifications

Model	CS-3000S
Table Length	6000mm (236") (Standard)
Welding Table	3140mm x 890mm x 600mm (124" x 35" x 24")
Floor Requirement	5.7sqm
Welding Width	10mm - 40mm (0.4" - 1.6")
Welding Speed	1000mm - 6000mm / min (39" - 236")
Rated Voltage	Single Phase 50Hz, AC 220V ± 10%
Power	3000W
Frequency	27.12 ± 0.5% MHz
Working Pressure	2 - 4kg
Air Requirement	6 bar
<b>Price</b>	<b>≤ \$14,049</b>

### ▼ Details



## CS-HWM-WY: Weldy Foiler PVC Banner Welder

It's widely used for flex banner, tent, pool liner, vinyl, mesh, etc.



Controller

- Adopting Leister hot air gun
- Reasonable machinery structure
- Welding speed up to 7.5 m/min
- Automatic cool down function
- Running steadily and joint material firmly

### ▼ Specifications

Model	CS-HWM-WY-I	CS-HWM-WY-II
Voltage	AC 220V ± 10%	AC 220V ± 10%
Frequency	50Hz	50Hz
Power	2100W	2100W
Working Temperature	80°C - 530°C	80°C - 530°C
Air Flow	200L - 270L / min	200L - 270L / min
Welding seam width	20mm (0.78")	30mm (1.18")
Driving Speed	1.0m - 7.5m / min (39" - 295")	1.0m - 7.5m / min (39" - 295")
Machine Dimension	445mm x 276mm x 280mm (17.5" x 10.8" x 11.0")	445mm x 276mm x 280mm (17.5" x 10.8" x 11.0")
<b>Price</b>	<b>≤ \$1,328</b>	<b>≤ \$1,328</b>

### ▼ Details

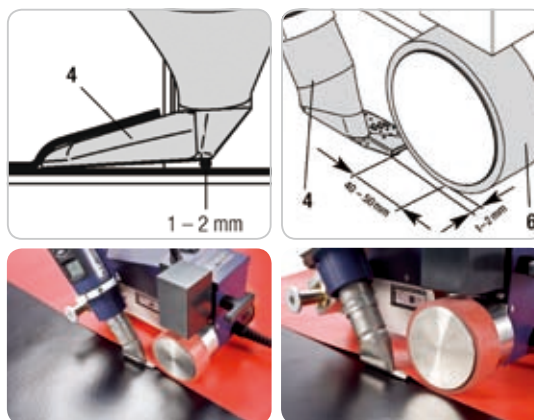

## CS-HWM-WY-ET: Weldy Foiler ET PVC Banner Welder

It's fast and easy to joint flex banner, tarpaulins and billboards, etc with any format steadily and durably.

### ▼ Specifications

Model	CS-HWM-WY-ET-20	CS-HWM-WY-ET-30
Voltage	AC 220V ± 10%	AC 220V ± 10%
Frequency	50Hz	50Hz
Power	1700W	1700W
Working Temperature	20°C - 650°C	20°C - 650°C
Air Flow	200L - 270L / min	200L - 270L / min
Welding seam width	20mm (0.78")	30mm (1.18")
Driving Speed	1.0m - 7.5m / min (39" - 295")	1.0m - 7.5m / min (39" - 295")
Machine Dimension	445mm x 276mm x 280mm (17.5" x 10.8" x 11.0")	445mm x 276mm x 280mm (17.5" x 10.8" x 11.0")
<b>Price</b>	<b>≤ \$1,348</b>	<b>≤ \$1,348</b>

- Adopting Leister hot air gun
- Designed by Swiss engineers
- Welding speed up to 7.5 m/min
- Automatic cool down function
- Running steadily and joint material firmly
- Fast and easy welding for tarpaulins and billboards

### ▼ Details



## CS-HWM-7001A: High - power Hot Air Flex Banner Welder

It's smart and easy to joint flex banner, mesh, vinyl and tent ,etc.

- Adopting LEISTER hot air gun
- Widely used for thicker materials within 3mm
- Running steadily and joint material firmly
- Reasonable machinery structure for durable usage

The welder is only used for the countries using the voltage of 220V.

Reasonable machinery structure makes the machine running steadily and joint materials firmly and looks flat and elaborate.

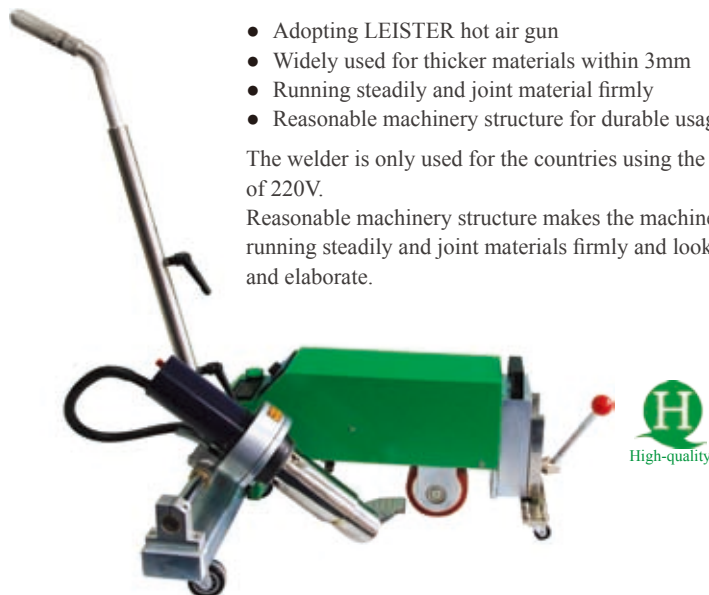

### ▼ Specifications



Model	CS-HWM-7001A
Voltage	AC 220V ± 10%
Frequency	50Hz
Power	3400W
Working Temperature	200°C - 6200°C
Air Flow	500L / min
Pressure Static	Maximum 5000Pa
Driving Speed	1.5 - 6m / min
Machine Dimension	600mm x 430mm x 310mm (24" x 17" x 12")

**Price** ≤ \$2,193

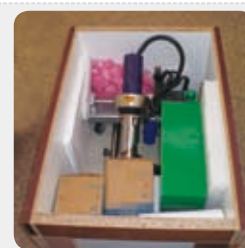

Packing



Digital display panel



Head of machine



Hot air gun



Laser ray positioning



Welding wheel

## CS-HWM-JN-PJ: New Style Hot Air Welder

This machine is widely used for welding Flex Banner, housetop tarpaulin, swimming pool, Membrane water bed, inflatable toys, etc.

- New hot air banner welder with motor set outside
- Enough hot air generated from the motor
- Reasonable machinery structure for long life - span
- Adopt advanced welding technology and high-precision temperature controlling
- Automatic turn on / off
- Turn off the hot air motor directly when you don't switch off the power
- The welder can remember the temperature set last time when use it again

### ▼ Specifications



Model	CS-HWM-JN-PJ
Voltage	AC 220V ± 10%
Frequency	50HZ
Power	3680W
Welding Width	40mm (1.57")
Welding Speed	1m -15m / min (39" - 590") (Continuously adjustable)
Hot Air Flow	28m <sup>3</sup> / h (Continuously adjustable)
Welding Temperature	40 ~ 650°C ± 1°C (Continuously adjustable)
Dimension	600mm x 430mm x 300mm (23.6" x 16.9" x 11.8")

**Price** ≤ \$1,195





## CS-HWM-6001B: Durable Hot Air Flex Banner Welder

It's used for jointing flex banner, mesh, vinyl, tent, etc.

- Adopting LEISTER hot air gun
- Joint material within 2mm (0.08") thick
- Running steadily and joint material firmly
- Reasonable machinery structure for durable usage

The welder is only used for the countries using the voltage of 220V.

### ▼ Specifications

Model	CS-HWM-6001B
Voltage	AC 220V ± 10%
Frequency	50Hz
Power	1600W
Motor Power	15W
Working Temperature	400°C
Welding Width	30mm (1.2")
Driving Speed	1.5 - 6m / min
Machine Dimension	500mm x 300mm x 280mm (20" x 12" x 11")
<b>Price</b>	<b>≤ \$1,498</b>



## CS-HWM-6001C: Smart Hot Air Flex Banner Welder

It's used for jointing flex banner, mesh, vinyl, tent, etc.

- Adopting LEISTER hot air gun
- Smart style, lighter and simple
- Affordable with reasonable price
- Joint material within 2mm (0.08") thick
- Running steadily and joint material firmly

It's smart one and lighter for easy to be shipping. The machine has delicate outer appearance and easy to operate.

### ▼ Specifications

Model	CS-HWM-6001C
Voltage	AC 220V ± 10%
Frequency	50Hz
Power	2100W
Air Flow	(20°C) 200 - 270L / min
Working Temperature	80°C - 530°C
Welding Width	30mm (1.2")
Driving Speed	1.0 - 6m / min
Machine Dimension	445mm x 276mm x 280mm (17.5" x 11" x 11")
<b>Price</b>	<b>≤ \$877</b>



**Note:** The welder is only for the countries using the voltage of 220V.

> Laminator & Finishing Equipments > Vinyl banner slitter & welder

### CS-FQ-1600S-JF: Banner Slitter & Rewinder

Applying to cut flex vinyl, mesh, white solvent vinyl, one way vision, self - adhesive vinyl, reflective sheeting, reflective sheeting, application tape, foam adhesive tape, and double - sides adhesive tape, etc.

- Two cutting heads, one is with round blade and the other is using the blade with teeth
- Advertising material cutting machine
- Horizontal cutting and vertical cutting are both ok
- Digital display for reeling - in & expanding length
- Semi - automatic cutting width control



▼ Specifications

<b>Model</b>	<b>CS-FQ-1600S-JF</b>
Rated Voltage	Single Phase 50Hz, AC 220V ± 10%
Maximum Cutting Width	3200mm (126")
Cutting Speed	0 ~ 300rpm
Rated Power	1000W
Maximum Diameter	Φ280mm (11")
Shape Size	4100mm x 850mm x 1000mm (161" x 33" x 39")
Rewind	Yes
Horizontal Cut	Yes
<b>Price</b>	<b>≤ \$10,157</b>

▼ Samples



▼ Details



Blade head



Operation buttons



Operation buttons



Round blade with teeth



Round blade



Measuring instruments

### CS-FQ-1600S: Banner Slitter for Vertical Cutting

It's widely used for flex vinyl, blockout, mesh, one way vision, self - adhesive vinyl, reflective sheeting, application tape, foam adhesive tape, and double - sides adhesive tape, etc.

- Banner slitter is with special double support rollers
- Frequency converters adopted for both roller and cutting blade
- Cut advertising materials vertically

▼ Specifications

<b>Model</b>	<b>CS-FQ-1600S</b>
Rated Voltage	Single Phase 50Hz, AC 220V ± 10%
Maximum Cutting Width	3200mm (126")
Cutting Speed	0 - 300rpm
Rated Power	1000W
Maximum Diameter	Φ320mm (12.6")
Machine Dimension	4100mm x 800mm x 1000mm (161" x 31" x 39")
<b>Price</b>	<b>≤ \$9,254</b>

▼ Samples

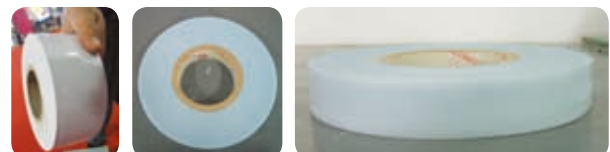

## CS-FQ750: Precisely Banner Roll Slitter

It is used to cut flex vinyl, mesh, white solvent vinyl, one way vision, self - adhesive vinyl, reflective sheeting, application tape, foam adhesive tape, and double - sides adhesive tape, etc.

- Roll Slitter with simple structure
- Cutting materials precisely up to 5mm (0.2") width
- With a motorized core shaft and single - blade
- Simple structure and convenient to operate



Fixer wheel



Fixer



Material supporter

### ▼ Specifications

Model	CS-FQ750-160	CS-FQ750-190
Voltage	Single Phase 50Hz, AC 220V ± 10%	Single Phase 50Hz, AC 220V ± 10%
Maximum Input Power	750W	750W
Roll Maximum Width	1600mm (63")	1900mm (75")
Roll - slit Maximum Outer Diameter	200mm (8")	250mm (10")
Roll - slit Core Inner Diameter	76mm (3")	76mm (3")
Shape Size	2585mm x 690mm x 520mm (102" x 27" x 20")	2950mm x 900mm x 700mm (116" x 35" x 27")
<b>Price</b>	<b>≤ \$5,890</b>	<b>≤ \$6,535</b>



### ▼ Samples



## CS-M Series Aluminum Alloy Paper Trimmer

Applying to paper within 1mm (0.039") and also outdoor printing materials, such as PVC foam board, KT board, KAPA board, etc whose thickness is within 8mm (0.31").

- Aluminum alloy machine with stand
- It's convenient and efficient
- No rough edges on finished products
- T - shape blade, sharp and durable
- Designed with paper - fixing function
- Both inch and centimeter scale precisely is designed on the cutter



High-quality



### ▼ Specifications

Model	CS-M-001	CS-M-002	CS-M-003	CS-M-004
Size	40 inch	60 inch	80 inch	100 inch
Working Table	1180mm x 330mm (46" x 13")	1680mm x 330mm (66" x 13")	2180mm x 330mm (86" x 13")	2680mm x 330mm (105" x 13")
Breadth	1000mm (39")	1500mm (59")	2000mm (79")	2500mm (98")
<b>Price</b>	<b>≤ \$318</b>	<b>≤ \$421</b>	<b>≤ \$868</b>	<b>≤ \$1,189</b>



Blade head

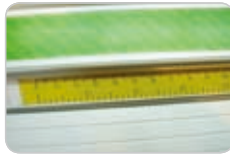

Measurement ruler

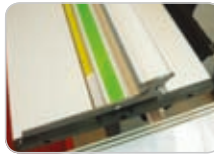

Working table



Support stand

## PT-TS-B: 100 Inch Wide Format Paper Trimmer with Support Stand

Applying to paper within 1mm (0.039") and also outdoor printing materials, such as PVC foam board, KT board, KAPA board, etc whose thickness is within 8mm (0.31").

- Economical Paper Trimmer
- Aluminum alloy machine with stand
- It's convenient and efficient
- No rough edges on finished products
- T - shape blade, sharp and durable
- Designed with paper - fixing function

### ▼ Specifications

Model	PT-TS-B
Size	100 inch
Working Table	2680mm x 330mm (105" x 13")
Breadth	2500mm (98")
<b>Price</b>	<b>≤ \$678</b>



Economical



Packing Details

## CS-I series Rotary Paper Trimmer

This rotary paper cutter is used to cut paper within the thickness of 1mm (0.039").

- Convenient and efficient
- Sharp and durable blade
- Especially for paper cutting
- Designed with paper - fixing function
- Inch and centimeter scale precisely designed on the cutter

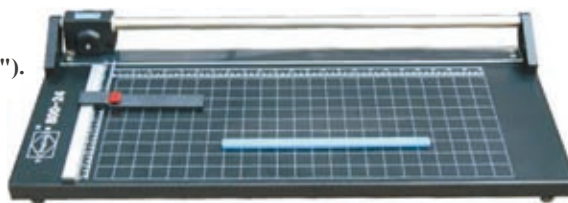

CS-I-001

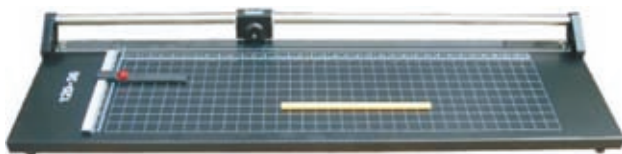

CS-I-002

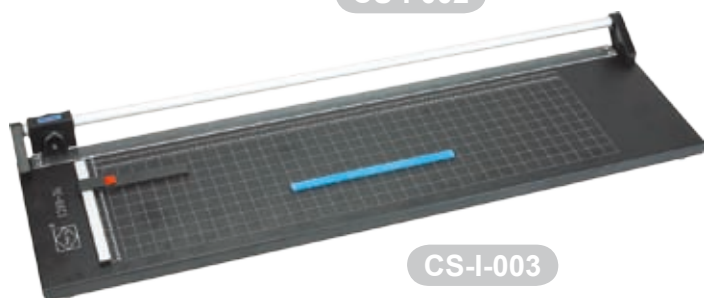

CS-I-003



Packing Details

### ▼ Specifications

Model	CS-I-001	CS-I-002	CS-I-003	CS-I-004	CS-I-005	CS-I-006	CS-I-007
Size	14 inch	24 inch	36 inch	48 inch	63 inch	71 inch	79 inch
Working Table	550mm x 280mm (22" x 11")	800mm x 315mm (31" x 12")	1200mm x 330mm (47" x 13")	1460mm x 330mm (57" x 13")	1800mm x 330mm (71" x 13")	2000mm x 330mm (79" x 13")	2200mm x 330mm (87" x 13")
Breadth	350mm (14")	600mm (24")	970mm (38")	1250mm (49")	1600mm (63")	1800mm (71")	2000mm (79")
<b>Price</b>	≤ \$49.59	≤ \$55.87	≤ \$111.07	≤ \$141.82	≤ \$212.23	≤ \$269.75	≤ \$500.00



## CS-IS series Support Stand of Rotary Paper Trimmer

This support stand is suitable for rotary paper trimmer.



- Match with rotary paper trimmer
- Convenient to support the trimmer
- It's easy to use and operate flexibly
- More bigger than 48 inch can match with the stand

### ▼ Specifications

Model	CS-I-004S	CS-I-005S	CS-I-006S	CS-I-007S
Size	48 inch	63 inch	71 inch	79 inch
<b>Price</b>	≤ \$101.32	≤ \$127.77	≤ \$149.59	≤ \$176.69



### CS-ZG-CK: Banner Cutting Knife

This cutter is used for **cutting heat transferred cloth**.

- Smart cutter for vinyl banner
- It's easy to change the blade
- It's affordable and convenient to use



Price: ≤ \$4.3 / pc

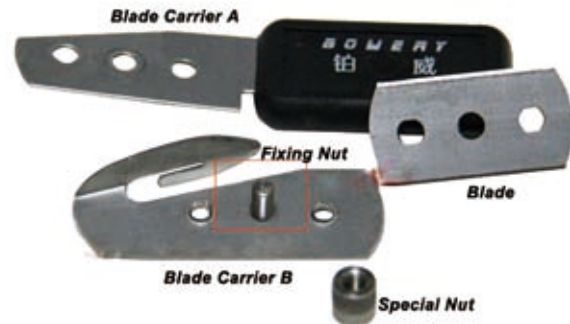

### CS-BC-JN-CC-03: Flex Banner Cutter

This cutter is used for **cutting heat transferred cloth**.

- Do the cutting work on the floor stand no need the table
- No need power, it's working by the operator
- It's very easy to operate and convenient to carry
- Power saving, no need electricity.
- Safe, reasonable blade structure keep away of lacerating hands
- Longer life - time, the blade and the ground has no direct scrape to prolong the lifetime

Price: ≤ \$15.7 / pc



### CS-GM-APD120: Pneumatic Grommet Machine for Plastic Eyelets

The machine can press advertising materials such as Flex Banner, cover cloth, non - woven cloth, oxford, water - proof cloth, canvas, tent, packing bags, outdoor goods etc.

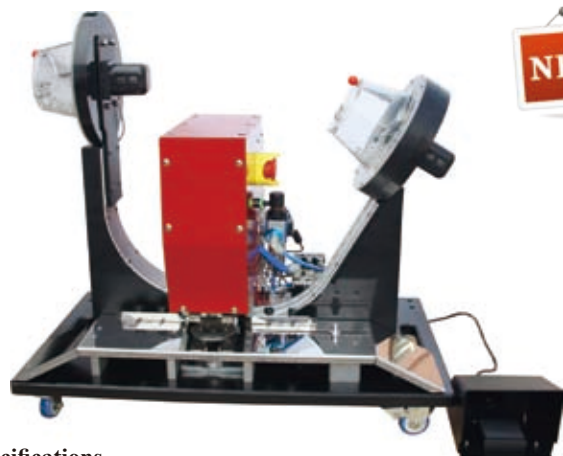

- Pneumatic control system
- Punching and pressing are synchronous
- Humanized design, safeguard device
- Practical plastic grommets are used
- No noise, easy to operate
- Automatic supplying system for high - efficient working
- Safeguard device helps to achieve safety and reliable operation
- Plastic grommets are beautiful and never rusty, easy to recycle

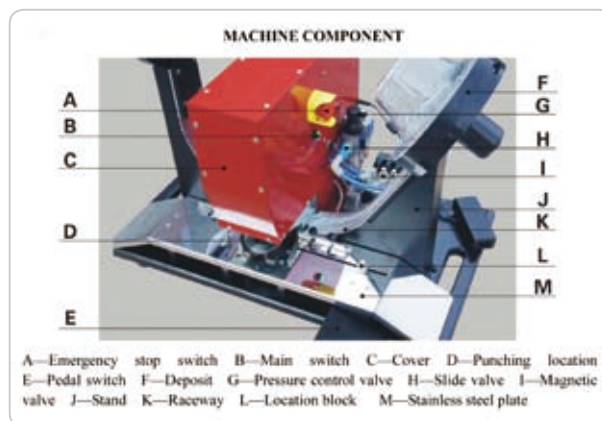

▼ Specifications

<b>Model</b>	<b>CS-GM-APD120</b>
Rated Voltage	24V
Power	38W
Pressure	0.6MP
Inner Diameter of Grommet	ID = 12mm (0.47")
Grommet Spacing	Self - chosen
<b>Price</b>	<b>≤ \$1,946</b>



### CS-GM-HED120: Table Type Automatic Grommet Machine

The machine can press advertising materials such as Flex Banner, cover cloth, non - woven cloth, oxford, water - proof cloth, canvas, tent, packing bags, outdoor goods etc.

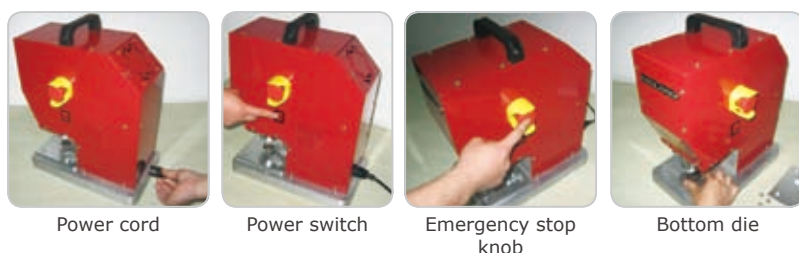

▼ Specifications

Model	CS-GM-HED120-I	CS-GM-HED120-II	CS-GM-HED120-III
Rated Voltage	Single Phase 50Hz, AC 220V ± 10%	Single Phase 50Hz, AC 220V ± 10%	Single Phase 50Hz, AC 220V ± 10%
Power	150W	150W	150W
Material of Grommet	Plastic	Metal	Metal
Inner Diameter of Grommet	ID = 12mm (0.47")	ID = 8mm (0.31")	ID = 12mm (0.47")
Grommet Spacing	Self - chosen	Self - chosen	Self - chosen
<b>Price</b>	<b>≤ \$1,106</b>	<b>≤ \$1,106</b>	<b>≤ \$1,106</b>

- Electric control, no air compressor is needed
- Punching and pressing are synchronous
- Humanized design, safeguard device
- Practical plastic grommets are used
- Safeguard device helps to achieve safety and reliable operation

> Laminator & Finishing Equipments > Grommet machine

### CS-GM-ST: Auto - grommet Machine

Punching grommets on advertising materials, such as flex banner, tent tarpaulin, etc



- Automatically, convenient and firm
- Time - saving and labor - saving
- Adopting laser ray to guide operation on precise position
- Ground working and table working are both available

Grommets punched by this machine are very firm and hard to turn

New designed product for eyelet punching along the cloth freely, automatically and fast

▼ Specifications

Model	CS-GM-ST
Rated Voltage	Single Phase 50Hz, AC 220V ± 10%
Machine Dimension	920mm x 680mm x 398mm (36" x 26" x 15" )
Power	600 - 700W
Speed	1500pc / hr
Available Grommet Sizes	(ID = 10.4mm (0.4"), OD = 18.5mm (0.7")) (ID = 13mm (0.5"), OD = 21.5mm (0.85"))
<b>Price</b>	<b>≤ \$1,320</b>



Reseting    Punching    Feeding



Finished product



**Note:** One machine can only punch one size of grommets.

This kind of machine can be made individually to apply to the two sizes of grommets above.

### CS-GM-SQ / DQ: Pneumatic grommet Machine I

Punch a hole and press grommets on the flex banner, tents, tarpaulins, etc

- Press firmly
- Stable and durable
- Sensor designed for send grommet into the guide way

Convenient and removable to operate

Working on the ground or on the table

To perform collecting grommet, feeding grommet, piercing material and pressing grommet with washer together



▼ Specifications

Model	CS-DK-DQ	CS-DK-SQ
Maximum Input Power	<150VA	<150VA
Voltage	Single phase 50Hz, AC 220V ± 10%	Single phase 50Hz, AC 220V ± 10%
Air Requirement	6 bar	8 bar
Grommet Speed	1000pc / hr	1000pc / hr
Grommet Model Supported	No.4 (ID=10mm (0.4"), OD=16mm (0.6"))	No.5 (ID=10mm (0.4"), OD=19.5mm (0.8"))
Neighbor Grommet Distance	12mm to 22mm (0.5" to 0.9")	12mm to 22mm (0.5" to 0.9")
Cylinder Number	Single	Double
Machine Dimension	450mm x 500mm x 460mm (18" x 20"x 18")	450mm x 500mm x 460mm (18" x 20"x 18")
<b>Price</b>	<b>≤ \$1,747</b>	<b>≤ \$1,857</b>



Packing Details



## CS-GM-JN: Pneumatic Grommet Machine II



It's widely applying to **flex banner, leather, mesh, leather belt, especially for tent, tarpaulin, etc.**

- Pneumatic style, easy operation
- Two eyes automatically feeding box
- Automatic punching and riveting
- Convenient operation and high efficiency

### ▼ Specifications

Model	CS-GM-JN
Voltage	Single phase 50Hz, AC 220V ± 10%
Speed	30times / min ≤ frequency ≤ 60times / min
Air Pressure	≥6MPa
Thickness of Material	2mm (0.08")
Grommet Sizes	(ID=12mm (0.5"), OD=23mm (0.9"))
<b>Unit Price</b>	<b>≤ \$2,411</b>



With table



## CS-MGM-SD: Die - Changeable Manual Grommet Machine

Punch a hole and press grommets on the tents, tarpaulins, etc

- Affordable and Practical
- Smart and convenient
- Interchangeable dies
- Steady and durable
- No maintenance needed
- Various colors, such as silver grey, green, etc

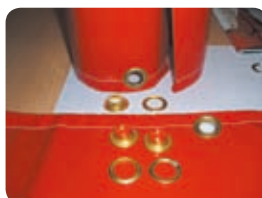

Finished product



Economical



Packing Details

### ▼ Grommet and washer (Inner diameter, outer diameter)

#4 (10.5mm (0.4"), 17.5mm (0.7"))

#5 (11.5mm (0.45"), 19.5mm (0.8"))

#6 (14mm (0.55"), 24mm (0.94"))

**Remark:** The price we provide above contains one machine and one mold (#4 mold / #5 mold / #6 mold is optional). And **\$9.5** should be added additionally if you want get one more mold.

Price: ≤ \$52 / set

### CS-MGM-ZG: Manual Eyelet Puncher

It's widely used for PVC banners, tarpaulin, garment, case and bag, etc.



- Smart eyelet puncher, easy to carry
- Redirecting transmission for convenient using
- Available for the eyelet with the inner diameter of 3 / 8"(9.5mm)
- With correct opening angle, you can press it by only one hand
- Magnetic dies fix the eyelet and washer well
- The handle made of special plastic material is anti - friction, anti - skid and easy holding

Price: ≤ \$18.62 / pc



Magnetic dies fix the eyelet and washer well



The handle made of special plastic material is anti - friction, anti - skid and easy holding



### CS-GM-JN-DKJ: Semi - automatic Grommet Machine

The grommet machine is used for the binding and riveting of inkjet advertisements, suitcases and bags, leather belts and waist belts, clothing leathers, stationeries and lighting decorations, particularly tents and rain gears.



- Semi automatic style, automatic grommet feeding
- No need power, it's working by the operator
- It's moving easily instead of standing on the fixing floor
- The size of grommet: OD = 16mm (0.63"), ID = 10mm (0.39"), H = 5mm (0.19")

Price: ≤ \$396 / set



## > Flower & Nail Art Printer

### F-NTAF05: Digital Multifunctional Nail Art Printer

Nail Beauty is becoming a new fashion developed quickly beauty industry after beauty parlor and hairdressing. It has become an important part for personal making up and image design.



**Function:** Print patterns, words or pictures on fingernails, toenails, decorations, mobile phone and flowers, fruit, egg, cell - phone, crystal, and golf, etc.

**Paint five fingernails at one time**

**Paint five toenails at one time**

**Paint three flowers at one time**

**Make crystal badge paint**

**All kinds of adornment**

#### ▼ Specifications

Model	F-NTAF05
Machine Dimension	400mm x 270mm x 270mm (16" x 10.6" x 10.6")
Machine Weight	10kg
Voltage	85 - 260V
Frequency	47 - 63Hz
Power	270W / 18W
Environmental Temperature	15°C - 40°C
<b>Price</b>	<b>≤ \$783 / set</b>



#### ▼ Standard Accessories

Item	Qty
Host machine	1 set
Fingernail beautifying device	1 pc
Toenail beautifying device	1 pc
Flower beautifying device	1 pc
Adornment beautifying device	1 pc
Special painting liquid	1 pc
Colored & black ink cartridge	1 pc
Power line	1 pc
Books of pattern gallery	2 pcs
Warranty certificate	1 pc
Special notice	1 pc
Quality certificate	1 pc
Demo video disk	1 pc
Affiliated disk (Contains our painting system software and drivers, pattern database)	1 pc

#### ▼ Samples

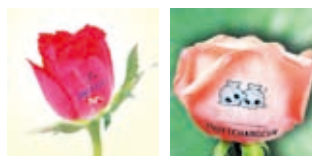

#### ▼ Artificial Nails



## &gt; Flower &amp; Nail Art Printer

**SIC-HN-CF-NTAF05C: Multifunctional Nail Art and Flower Printer with Camera & PC inside**

It is mainly used for personal printing on nails and flowers, which can open new business opportunities. It is widely used in many areas, such as Image Design Center, Beauty Salon, Wedding Studio, Fashion Store, Nail Salon, Hair Salon and Shopping Mall, etc.



- PC inside
- Intelligent identification and Auto alignment tool in the software.
- Pictures can be made on site using the software photo tools.
- Unique color changes function in the software.
- Multifunctional, rapid and efficient to use.
- Different designs to use and apply them on nail and flowers.
- Special painting liquid of perfect finished.
- Rich pattern database and update content it is available.
- Environmental design.
- Paint five fingernails or five toenails at the same time.
- Paints in three flowers.

## ▼ Specifications

Model	SIC-HN-CF-NTAF05C
Machine Dimension	565mm x 545mm x 520mm (22" x 21" x 20")
Machine Weight	50.61b (23kg)
Voltage	85 - 260V
Frequency	47 - 63Hz
Power	50W
Environmental Temperature	15°C - 40°C
<b>Price</b>	<b>≤ \$1,320 / set</b>

## ▼ Standard Accessories

Item	Qty
Host machine	1 set
Fingernail beautifying device	1 pc
Toenail beautifying device	1 pc
Flower beautifying device	1 pc
Adornment beautifying device	1 pc
Special painting liquid	1 pc
Colored & black ink cartridge	1 pc
Power line	1 pc
Books of pattern gallery	2 pcs
Warranty certificate	1 pc
Special notice	1 pc
Quality certificate	1 pc
Demo video disk	1 pc

## ▼ Samples

**Automatic Cold and Hot Air Nail Dryer**

With the dryer, the printed nail can be dried faster.

**Price:** ≤ \$51.4 / set



## > Flower & Nail Art Printer

### SIC-QDYN-N4: Nail Printer (Touch Screen + Intelligent Identification System)

This nail printer is mainly used for personal printing on nails, this can open new business opportunities. It is widely used in many areas, such as Image Design Center, Beauty Parlor, Wedding Studio, Fashion Store, Nail Salon, Hair Salon, Shopping Mall, etc.

- Intelligent Identification System
- 8 inches Touch Screen, Built - in computer system
- Special software with strong functions, by which we can take and edit photos
- High Resolution Camera for Present Prompt Photo - taking
- There are hundreds of ready - made patterns for selection in the latest gallery
- Support for importing your self - provided DIY patterns temporarily
- Adjustable size, direction and location of the pattern on the nail precisely

#### ▼ Specifications

Model	SIC-QDYN-N4
Machine Dimension	500mm x 320mm x 320mm (20" x 12.6" x 12.6")
Machine Weight	39.6Ib (18kg)
Voltage	110V - 220V
Power	50W
Printing Speed	One Nail / 8 Second
Printer Resolution	4800 x 1200dpi
<b>Price</b>	<b>≤ \$1,873 / set</b>



#### ▼ Samples

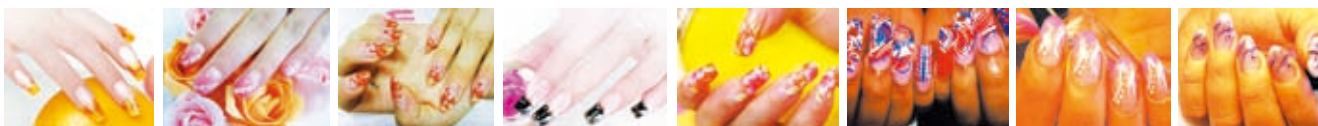

### SIC-QDYN-FM03: Mini Flower Printer

The flower printer can print any designs directly on flower and various personalized designs, such as photos, words on fresh or artificial flowers. Electrical operation system and the special software with finest functions can take and edit photos and words on spot.



- 3 million high resolution camera
- Finest function for present writing and editing
- Fast drying and waterproof
- Adjustable flower - jig
- Millions of designs are saved for you.
- Creative and fashionable

#### ▼ Specifications

Model	SIC-QDYN-FM03
Machine Dimension	500mm x 350mm 330mm (20" x 14" x 13")
Machine Weight	26.4Ib (12kg)
Voltage	110 - 220V
Printing Speed	One Nail / 8 Second
Printer Resolution	4800 x 1200dpi
<b>Price</b>	<b>≤ \$718 / set</b>

#### ▼ Samples



## &gt; Inkjet Printhead

**PRH-SPT-001: Seiko SPT255 / 35pl Printhead**

Used for Icontek TW-3306GA; ZHONGYE ZY-3400; SID XE210, SID XE320; Phoaeton UD-323H, Phoaeton UD-213H

**Original**

**Price: ≤ \$767.00**

**PRH-SPT-002-E: Seiko SPT510 / 35pl Printhead**

Used for Icontek TW-3306HC / TW-3308HC / TW-3306HA / TW-1806A / TW-3306HD / TW-3308HD / TW-3308HZ, Icontek M1 / M3; SID XCS PLUS 320-8H / XCS 320-8H, XES 250 / XES 320, XH250; Crystaljet S1806SPT510\_35PL / S3306IISPT510\_35PL / S4306SPT510\_35PL, F3308IISPT510\_35PL / F4308SPT510\_35PL / F6308IISPT510\_35PL; Infiniti FY-3208HA / FY-3206HA / FY-3208HF / FY-3206HF / FY-3208H / FY-3206H / FY-3208R / FY-3206R / FY-3208G / FY-3204G; Phoaeton UD-3206E / UD-3208E / UD-3206G / UD-3208G / UD-3208GF / UD-3206GF / UD-3208H; Roland AJ-1000 / AJ-740; VUTEK / QS3200 / QS3200R

**Original**

**Price: ≤ \$1,068.00**

**PRH-SPT-002-F: Seiko SPT510 / 35pl Printhead with New IC Driver**

Used for Icontek TW-3306GA; ZHONGYE ZY-3400; SID XE210 / SID XE320; Phoaeton UD-323H / Phoaeton UD-213H

**Original**

**Price: ≤ \$1,018.00**

**PRH-SPT-003: Seiko SPT1020 / 35pl Printhead**

Used for Icontek TW-3306FD / Icontek TW-3308FD / Icontek TW-1800F3 / Icontek TW-2500F3 / Icontek TW-3306FZ / Icontek TW-3308FZ, Icontek M5 / Icontek M7; SID XC II; Crystaljet CJ-FB2506UV, Crystaljet S6306SPT1020\_35PL, Crystaljet F6308SPT1020\_35PL; Infiniti FY-3266K / Infiniti FY-3266H / Infiniti FY-3266J / Infiniti FY-3266R; Phoaeton UD-3266E / Phoaeton UD-3266G

**Original**

**Price: ≤ \$1,736.00**

**PRH-SPT-004: Seiko SPT255 / 12pl Printhead**

Used for SID XQ210; Crystaljet S1806SPT255\_12PL

**Original**

**Price: ≤ \$701.00**

**PRH-SPT-005: Seiko SPT510 / 50pl Printhead**

Used for Crystaljet F1804SPT510\_50PL / Crystaljet F3304IISPT510\_50PL / Crystaljet F4304SPT510\_50PL / Crystaljet F4308SPT510\_50PL / Crystaljet F6308IISPT510\_50PL, Crystaljet S4306SPT510\_50PL / Crystaljet S6306IISPT510\_50PL; Infiniti FY-3278N / Infiniti FY-3276HA, Infiniti FY-3278F / Infiniti FY-3276R; Phoaeton UD-3278D / Phoaeton UD-3276E / Phoaeton UD-3278K

**Original**

**Price: ≤ \$1,060.00**

**PRH-SPT-007: Seiko 508GS / 12pl Print Head**

**Original**

**Price: ≤ \$1,919.00**

**PRH-KON-001: Konica Minolta 512 / 14pl (KM512MN) Printhead**

Used for HP designjet 9000s / Designjet 10000s; Seiko Colorpainter 64s / Colorpainter 100s; OCE CS 6060 / CS 6100; DGI ST1806

**Original**

**Price: ≤ \$1,085.00**

**PRH-KON-002: Konica 256 / 14pl Printhead**

Used for Human X-JetB 1808

**Original**

**Price: ≤ \$684.00**

**PRH-KON-003: Konica 512 / 14pl UV (KM512MH) Printhead**

Used for NEOTITAN UV-T-1606W(S) / NEOTITAN UV-T-2506W(S); FLORA F250UV / FLORA F250UV; SKYJET UV FlatMaser 2512 / SKYJET UV FlatMaser 2518 / SKYJET UV FlatMaser 3020 / SKYJET UV FlatMaser 3022 / SKYJET UV FlatMaser-R.; KingColor UV1224C / KingColor UV2030C; Flora F1250UV, Flora PP2512UV Turbo, Flora F1 320UV; RODIN K7250UV, DOCAN UV2510, DOACN UV1528

**Original**

**Price: ≤ \$1,535.00**

**PRH-KON-004: Konica 256 / 42pl Printhead**

Used for LIYU PJ3204 / LIYU PJ3208

**Original**

**Price: ≤ \$659.00**

**PRH-KON-005: Konica Minolta KM512LN / 42pl Printhead**

Used for SKYJET-SD-3308KL-4C / SKYJET-SD-3312KL-6C / SKYJET-SD-3316KL-4C, SKYJET-SD-3324KL-6C / SKYJET-SD-5216KL-4C / SKYJET-SD-5224KL-4C; MYJET LA3204KM / MYJET LA3208KM, MYJET LB3204KM / MYJET LB3208KM, MYJET WD3212KM / MYJET WD3216KM; JHF A8 3312F / JHF A8 3308F; LEOPARD H8 3308F / LEOPARD H8 3306FS; Flora HJ3200, Flora LJ320K; HUMAN Ultra-Jet 3208 / HUMAN Ultra-Jet 3212 / HUMAN Ultra-Jet 3216, HUMAN K-Jet 3208

**Original**

**Price: ≤ \$1,018.00**

**PRH-KON-006: Konica 1024 / 14pl UV Printhead**

**Original**

**Price: ≤ \$2,544.00**

**PRH-KON-007: Konica 1024 / 14pl MNB Printhead**

**Original**

**Price: ≤ \$2,003.00**

**PRH-KON-008: Konica KM1024LNB / 42pl Printhead**

**Original**

**Price: ≤ \$2,003.00**

**PRH-KON-010: Konica KM512 LH / 42pl UV Printhead**

**Original**

**Price: ≤ \$1,585.00**

**PRH-SPE-001: Spectra Nova 256 / 80 AAA Printhead**

Used for Wit-color Ultra1000-NOVA-5208 / WIT-COLOR Ultra1000-NOVA-3308; DGI PS-3204D; Flora LJ 320SE, Flora HJII3200/5000SE; YISHAN PS-3204S / YISHAN POLAJET PS-3204DX, YISHAN YS5008-EE; Vutek Ultravu3360; Teckwin Teckpro S3200

**Original**

**Price: ≤ \$2,203.00**

**PRH-SPE-002: Spectra S-Class SL-128 AA Printhead**

Used for Swift 3360; Infinity FY-6250SL

**Original**

**Price: ≤ \$943.00**

**PRH-SPE-003: Spectra Skywalker HD 128 / 50 Printhead**

Used for Wit-color Ultra1000-Skywalker-12H / WIT-color Ultra1000-Skywalker-16H; APRINT 250Nano, APRINT 330Nano-8 / APRINT 330Nano-12; Flora HJII5000SW, Flora LJ320SW; GONGZHENG GZT3212AK / GONGZHENG GZCK3212AK; ORASIGN W-JET320SW

**Original**

**Price: ≤ \$409.00**

## &gt; Inkjet Printhead



**PRH-SPE-004: Spectra S-Class SM-128 AA Printhead**  
Used for SID UV200S; AGFA 2030 X-2  
**Original**  
**Price: ≤ \$932.00**



**PRH-SPE-005: Spectra S-Class SE-128 AA Printhead**  
Used for AGFA 3150 X-2  
**Original**  
**Price: ≤ \$932.00**



**PRH-SPE-006: Spectra Polaris PQ-512 / 35 AAA Printhead**  
Used for ORASIGN W-320PQ / ORASIGN W-180PQ; WIT-COLOR ULTRA4000 4H / 6H / WIT-COLOR ULTRA4000 8H; Flora LJ320P; GONGZHENG GZT3204 / GONGZHENG GZT3202 / GONGZHENG GZT3208AU, GONGZHENG GZR3208; JHF A8 3304PQ / JHF A8 3308PQ; LEOPARD Q8 3304PQ / LEOPARD Q8 3308PQ; APRINT 330P  
**Original**  
**Price: ≤ \$1,886.00**



**PRH-SPE-007: Spectra Polaris PQ-512 / 15 AAA Printhead**  
Used for LIYU PS3204-S512 / LIYU PS3208-S512; Rodin P9320-B (4H) / Rodin P9320-B (8H); Flora PP2512UV; SMART UV printer; JHF UV R5000 / JHF UV R3300 / JHF UV R5000S / JHF UV R3300S; LEOPARD E3000, LEOPARD S2600  
**Original**  
**Price: ≤ \$1,886.00**



**PRH-XAAR-001: Xaar 128 / 80 Printhead (Blue)**  
Used for DGI VT-100D / VT-62D / VT-92, VTII-62 / VTII-62P / VTII-92 / VTII-92P, VTHI-98D / VTHI-98DS, VTIV-62 / VTIV-98, VTV-1604 / VTV-1606 / VTV-2504 / VTV-2506; HP Scitex XL1200 / HP Scitex XL1500; JHF VISTA Vista1808 / Vista2508 / Vista3312; Myjet 3216; LIYU PM1808  
**Original**  
**Price: ≤ \$263.77**



**PRH-XAAR-002: Xaar 128/80-W Printhead (Purple)**  
Used for large format printer, Infiniti, Liyu, Limitless  
**Original**  
**Price: ≤ 263.77**



**PRH-XAAR-003: Xaar 126 / 50 Printhead**  
Used for Algotex Rainow 250 / Rainbow 325; Aprint 330 Speedy; Vinylking 160; Azon UV 1600 FR; Graphtec SignJet Pro JS300; Sun New Drakar / New Drakar Pro; YaseLAN Picasso YSL-D1600FBUV  
**Original**  
**Price: ≤ \$263.77**



**PRH-XAAR-004: Original New Xaar 128 / 40W Printhead (Light Grey)**  
Used for Wit-color 720T / WIT-color 860+  
**Original**  
**Price: ≤ \$263.77**



**PRH-XAAR-005: Xaar XJ-126 / 80 Printhead**  
Used for Infiniti FY-6150 / FY-8250 / FY-3312C  
**Original**  
**Price: ≤ \$263.77**



**PRH-XAAR-006: Xaar 126 / 35 Printhead**  
Used for ORASIGN W-jet160  
**Original**  
**Price: ≤ \$263.77**



**PRH-XAAR-007: Xaar XJ500 / 80 Printhead**  
Used for MYJET LA3208XR / MYJET LA3204XR, MYJET LB3204XR / MYJET LB3208XR, MYJET WD3212XR / MYJET WD3216XR; LIYU PE3204-XR382; LIYU PE3208-XR382; Wit-color ULTRA2000 H4/H6 / WIT-COLOR ULTRA2000 H8 / WIT-COLOR ULTRA2000 H12 / WIT-COLOR ULTRA2000 H16; SMART PROTON 8H, SMART 600 8H, SMART3000 4H / SMART3000 6H / SMART3000 12H, SMAT2000 S12 / SMAT2000 S16; SID UV 165P  
**Original**  
**Price: ≤ \$1,769.00**



**PRH-XAAR-008: Xaar 382 / 35 Printhead**  
Used for Wit-COLOR ULTRA3000 4H / WIT-COLOR ULTRA3000 6H / WIT-COLOR ULTRA3000 8H; MYJET WD3216XR60 / MYJET WD3212XR60  
**Original**  
**Price: ≤ \$818.00**



**PRH-XAAR-009: Xaar XJ-500 / 40-U-printhead**  
Used for YISHAN YS5008-CE / YISHAN YS3508-CF  
**Original**  
**Price: ≤ \$1,836.00**



**PRH-XAAR-010: Xaar 382 / 60 Printhead**  
**Original**  
**Price: ≤ \$826.00**



**PRH-EPS-006: Epson 7800 / 9800 Printhead (DX5) - F160000 / F160010**  
Used for Epson Stylus Pro 4400 / Epson Stylus Pro 4800 / Epson Stylus Pro 7400 / Epson Stylus Pro 7800 / Epson Stylus Pro 9400 / Epson Stylus Pro 9800  
**Original**  
**Price: ≤ \$1,068.00**



**PRH-EPS-007: Epson R1800 Printhead (DX5) - F158000**  
Used for Epson Stylus Photo R1800  
**Original**  
**Price: ≤ \$968.00**



**PRH-EPS-008: Epson R2400 Printhead (DX5) - F158010**  
Used for Epson Stylus Photo R2400  
**Original**  
**Price: ≤ \$968.00**



**PRH-EPS-009: Epson Stylus Pro 4880 / 7880 / 9880 Printhead (DX5) - F187000**  
Used for Epson Stylus Pro 4880 / Epson Stylus Pro 9880 / Epson Stylus Pro 7880 / Epson Stylus Pro 9450  
**Original**  
**Price: ≤ \$1,001.00**



**PRH-EPS-010: Epson R1900 / R2000 / R2880 Printhead (DX5) - F186000**  
Used for Epson Stylus Photo R1900 / Epson Stylus Photo R2880 / Epson Stylus Photo R2000  
**Original**  
**Price: ≤ \$1,160.00**



**PRH-EPS-011: Epson R4910 / 4900 Printhead - F198000**  
Used for Epson Stylus Photo R4910 / Epson Stylus Photo 4900  
**Original**  
**Price: ≤ \$1,469.00**

## &gt; Inkjet Printhead

**PRH-EPS-012: Epson R210 / R310 / R200 Printhead - F151000 / F166000**

Used for Epson Stylus Photo R200 / Epson Stylus Photo R210 / Epson Stylus Photo R220 / Epson Stylus Photo R230 / Epson Stylus Photo R300 / Epson Stylus Photo R310 / Epson Stylus Photo R320 / Epson Stylus Photo R340 / Epson Stylus Photo R350 / Epson Stylus Photo R510, Epson Stylus Photo 600F / Epson Stylus Photo 620F

**Original**  
**Price: ≤ \$100.17**

**PRH-EPS-013: Epson 7700 / 9700 / 9910 / 7910 Printhead - F191040 / F191010**

Used for Epson Stylus Pro 7700 / Epson Stylus Pro 9700 / Epson Stylus Pro 9910 / Epson Stylus Pro 9910 SPE / Epson Stylus Pro 7910 / Epson Stylus Pro WT7910 / Epson Stylus Pro 7910 SPE / Epson Stylus Pro 7908 / Epson Stylus Pro 7908 SPE / Epson Stylus Pro 9908 / Epson Stylus Pro 9908 SPE / Epson Stylus Pro 7900 / Epson Stylus Pro 9900 / Epson Stylus Pro 7710 / Epson Stylus Pro 7710M / Epson Stylus Pro 9710 / Epson Stylus Pro 9710M / Epson Stylus Pro 7890 / Epson Stylus Pro 9890 / Epson Stylus Pro 3890

**Original**  
**Price: ≤ \$2,036.00**

**PRH-EPS-016: Epson TX800 Printhead - F192040**

Used for Epson TX800

**Original**  
**Price: ≤ \$126.88**

**PRH-EPS-017: Epson Stylus Photo 1390 / 1400 / 1410 Printhead - F173050 / F173060**

Used for Epson Stylus Photo 1390 / Epson Stylus Photo 1400 / Epson Stylus Photo 1410

**Original**  
**Price: ≤ \$155.26**

**PRH-EPS-019: Epson R1900 Printhead Locked (DX5) - F186000**

Used for Epson Stylus Photo R1800 / Epson Stylus Photo R1900 / Epson Stylus Photo R2880 / Epson Stylus Photo R2000

**Original**  
**Price: ≤ \$809.00**

**PRH-EPS-020: Epson Stylus Photo R2400 Printhead Locked (DX5) - F158010**

Used for Epson R2400

**Original**  
**Price: ≤ \$776.00**

**PRH-EPS-021: Epson ME300 / ME 620F / L201 / L210 Printhead - F181010**

Used for Epson ME2 / ME200 / 620F / ME30 / ME300 / ME33 / ME330 / ME360 / ME510 / ME600F, L101 / L201 / L210

**Original**  
**Price: ≤ \$43.41**

**PRH-EPS-022: Epson PRO-9906D / B-310N / B-510DN Printhead - F189010**

Used for Epson PRO-9906D, Epson Stylus B-300 / Epson Stylus B-310N / Epson Stylus B-500DN / Epson Stylus B-510DN

**Original**  
**Price: ≤ \$980.00**

**PRH-EPS-023: Epson 3800 / 3850 Printhead - F177000**

Used for Epson Pro 3800 / 3850

**Original**  
**Price: ≤ \$651.00**

**PRH-EPS-024: Epson Pro-9906D Printhead (Locked) - F189010**

Used for Epson Pro-9906D

**Original**  
**Price: ≤ \$575.00**

**PRH-EPS-025: Epson TX650 / R290 / T50 / P50 Printhead - F180000**

Used for Epson TX650 / R280 / R290, T50 / T60, A50, P50

**Original**  
**Price: ≤ \$86.81**

**PRH-ROL-001: Roland FJ-540 / 740 Printhead - 6811909060**

Used for Roland HiFiJet Pro II FJ-540 / Roland HiFiJet Pro II FJ-740; Mimaki JV4 / Mimaki JV22, MimakiTX2; Mutoh RJ-8000

**Original**  
**Price: ≤ \$617.00**

**PRH-ROL-003: Original and 100% New Roland DX4 Eco Solvent Printhead - 1000002201**

Used for Roland SOLJET ProII SJ-540 / SJ-645EX / SJ-655EX / SJ-740 / SJ-745EX / SJ-1045EX / SJ-1000, SC-540, SC-545EX, Roland VersaCAMM SP-300V / SP-540V / VP-300I / VP-540I, Roland SOLJET PRO III XJ-640 / XJ-740, XC-540 / XC-540W / XC-545MT, Roland VersaArt RS-640; Mimaki jv3(jv3-130 / JV3-130sp / JV3-160 / JV3-160sp / JV3-250 / JV3-250sp etc.); Mutoh RH-II(Falcon2) / RH-3, Spitfire 65 / Spitfire 90, Blizzard 65 / Blizzard 90

**Original**  
**Price: ≤ \$684.00**

**PRH-ROL-004-BN: Roland BN-20 / XR-640 / SOLJET PRO4 XF-640 Printhead (DX7) - 6701409010**

Used for Roland BN-20, Roland XR-640, Roland SOLJET PRO4 XF-640, Roland RA-640, Roland RE-640, Roland VS-640, Roland FH740

**Original**  
**Price: ≤ \$1,669.00**

**PRH-ROL-005: Roland AJ-1000I / 740I Printhead - 1000001354#**

Used for Roland AJ-1000I / 740I

**Original**  
**Price: ≤ \$1,585.00**

**PRH-MIM-001: Mimaki JV5 / JV33 Printhead Original - M007947**

Used for Mimaki JV5 / Mimaki JV33, Mimaki CJV30

**Original**  
**Price: ≤ \$1,494.00**

**PRH-MUT-001: Mutoh VJ-1618 Printhead-DG-41914**

Used for Mutoh VJ-1618 / Mutoh VJ-1618W / Mutoh VJ-1618K / Mutoh VJ-1614

**Original**  
**Price: ≤ \$2,136.00**

**PRH-MUT-002: Mutoh VJ-1204 / VJ-1304 / VJ-1604 / VJ-1604W / VJ-1608 Printhead (DX5) -DF-49684**

Used for Mutoh VJ-1204 / VJ-1304 / VJ-1604 / VJ-1604W / VJ-1608

**Original**  
**Price: ≤ \$1,502.00**



## &gt; Inkjet Printhead

**PRH-MUT-003: Mutoh RJ-900C / RJ-901C (DX5) Printhead - DF-49029 / 44264**

Used for Mutoh RJ-900C

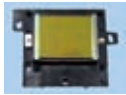
**Original****Price: ≤ \$1,068.00****PRH-MUT-004: Mutoh Valuejet 1628TD / 2628TD Printhead-DG-42771**

Used for Mutoh Valuejet 1628TD / Valuejet 2628TD

**Original****Price: ≤ \$1,803.00****PRH-MUT-005: Mutoh ValueJet 1638 / 1638W / 2638 Printhead-DG-43345**

Used for Mutoh Valuejet 1638 / Valuejet 1638W / Valuejet 2638

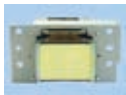
**Original****Price: ≤ \$1,803.00****PRH-MUT-006: Mutoh ValueJet 1324 / 1624 / 1624W / 1924W Printhead-DG-42987**

Used for Mutoh ValueJet 1324 / ValueJet1624 / ValueJet 1624W / ValueJet 1924W

**Original****Price: ≤ \$1,803.00****PRH-CAN-001: Canon QY6-0054 Printhead**

Used for PIXUS 450i / PIXUS 455i / PIXUS 470PD / PIXUS 475PD, PIXUS MP360 / PIXUS MP370 / PIXUS MP375R / PIXUS MP390 / PIXUS MP130 / PIXUS MP330, i450 / i455 / i470d / i475D, MultiPASS MP360 / MultiPASSMP 370 / MultiPASS MP390, imageCLASS MP360 / imageCLASS MP370 / imageCLASS MP390, SmartBase MP360 / SmartBase MP370 / SmartBase MP390, iP2000 / Ip1500, PIXMA MP110 / PIXMA MP130 / PIXMA MP410 / PIXMA MP430

**Original****Price: ≤ \$70.12****PRH-CAN-002: Canon QY6-0061 Printhead**

Used for iP4200 / iP5200 / iP5200R, RMP600, MP600R / MP800 / MP800R / MP830

**Original****Price: ≤ \$80.13****PRH-CAN-003: Canon QY6-0073 Printhead**

Used for iP3600, MP540 / MP620

**Original****Price: ≤ \$63.44****PRH-CAN-004: Canon QY6-0059 Printhead**

Used for iP4200, MP500 / MP530

**Original****Price: ≤ \$63.44****PRH-CAN-005: Canon BC-1300 Printhead**

Used for Canon BC-1300

**Original****Price: ≤ \$767.00****PRH-CAN-006: Canon QY6-0064 Printhead**

Used for PIXUS 560i / PIXUS 850i, PIXUS MP700 / PIXUS MP710 / PIXUS MP730 / PIXUS MP740, PIXUS i560 / PIXUS i850, MultiPASS MP700 / MultiPASS MP730, imageCLASS MP700 / imageCLASS MP730, SmartBase MP700 / SmartBase MP730, ip3100 / ip3000, ix4000 / ix5000

**Original****Price: ≤ \$88.48****PRH-CAN-007: Canon QY6-0076 Printhead**

Used for PIXUS 9900i / PIXUS 9910i / PIXUS i9900 / PIXUS i9950, iP8600 / iP8500 / PRO9000

**Original****Price: ≤ \$150.25****PRH-CAN-008: Canon QY6-0049 Printhead**

Used for PIXUS 860i / 865R, i860 / i865 / MP770 / MP790, Ip4000 / IP4100 / Ip4000R / Ip4100R, PIXMA MP750 / MP760 / MP780

**Original****Price: ≤ \$68.45****PRH-CAN-009: Canon QY6-0041 Printhead**

Used for PIXUS MP55 BJ-S700 / S750, MultiPASS F60 / F80

**Original****Price: ≤ \$136.89****PRH-CAN-010: Canon QY6-0045 Printhead**

Used for PIXUS 550i, i550

**Original****Price: ≤ \$126.88****PRH-CAN-012: Canon QY6-0074 Printhead**

Used for MP 980

**Original****Price: ≤ \$116.86****PRH-CAN-013: Canon QY6-0062 Printhead**

Used for ip7500 / ip7600, MP950 / MP960

**Original****Price: ≤ \$116.86****PRH-CAN-014: Canon QY6-0070 Printhead**

Used for iP3300 / iP3500, PIXMA MP510 / MP520, MX700

**Original****Price: ≤ \$66.78****PRH-CAN-015: Canon QY6-0072 Printhead**

Used for MP640, ip4680 / 4760, mf638/630

**Original****Price: ≤ \$80.13****PRH-CAN-016: Canon QY6-0075 Printhead**

Used for IP4500 / 5300, MP610

**Original****Price: ≤ \$91.82****PRH-CAN-017: Canon QY6-0080 Printhead**

Used for MG5280/5380, IX6580, MX888, IP4880 / 4840 / 4980, MG5280 / 5380

**Original****Price: ≤ \$113.52****PRH-CAN-018: Canon PF-03 Printhead**

Used for IPF510 / 650 / 815 / 825 / 5100 / 9110 / 9010S / 8000 / 9000

**Original****Price: ≤ \$459.00****PRH-CAN-019: Canon PF-04 Printhead**

Used for IPF650 / 655 / 750 / 760 / 765

**Original****Price: ≤ \$475.00**

## &gt; Inkjet Printhead

**PRH-CAN-020: Canon PF-05 Printhead**

Used for IPF6300S / 6350 / 8310S / 8300 / 9410S / 6410 / 6460 / 8410 / 9410

**Original****Price: ≤ \$459.00****PRH-CAN-021: Canon QY6-0037 Printhead**

Used for BJ S300 / S330, PIXUS MP5 / MP10, S300 / S330, Multi PASS F10 / F20, IMAGE CLASS MPC190 / MPC190S / MPC200, SMARE BASE MPC190 / MPC 200

**Original****Price: ≤ \$30.05****PRH-CAN-022: Canon QY6-0038 Printhead**

Used for BJ S200 S200 / S200X / S200SP / S200SPX

**Original****Price: ≤ \$28.38****PRH-CAN-024: Canon QY6-0069 Printhead**

Used for MINI 260

**Original****Price: ≤ \$33.39****PRH-CAN-029: New Canon QY6-0067 Printhead for Canon IP4500 / IP5300 / MP610 / MP810**

Used for Canon IP4500 / IP5300, MP610 / MP810

**Original****Price: ≤ \$90.15****PRH-CAN-030: QY6-0078 Genuine Canon Printhead**

Used for Canon MP990 / MP996

**Original****Price: ≤ \$200.33****PRH-NOV-001: Encad 750 Printhead without Chip**

Used for Encad 600 / Encad 630 / Encad 700 / Encad 736 / Encad 750 / Encad 850 / Encad 880 printers

**OEM****Price: ≤ \$19.20****PRH-NOV-002: Encad 750 Printhead with Chip**

Used for Encad 600 / Encad 630 / Encad 700 / Encad 736 / Encad 750 / Encad 850 / Encad 880 printers

**OEM****Price: ≤ \$24.21****PRH-NOV-003: Max Encad Printhead with Cartridge for 1200I / 1000I without Chip**

Used for Encad 1200I / 1000I

**OEM****Price: ≤ \$24.21****PRH-NOV-004: Max Encad Printhead with Cartridge for 1200I / 1000I with Chip**

Used for Encad 1200I / 1000I

**OEM****Price: ≤ \$30.05****PRH-RICOH-001: Ricoh Gen3 / 15pl Printhead****Original****Price: ≤ \$1,636.00****PRH-RICOH-002: Ricoh Gen4 / 7pl Printhead**

Used for Wit-Color UVIP 1313

**Original****Price: ≤ \$1,919.00**

## &gt; Printer Spare Parts &gt; Epson printer spare parts



**ACC-EPS-001: Epson DX4 / DX5 Printhead Big Damper**  
Used for Epson DX4 / DX5 head; Roland VP-300 / 540 / XC-540 / XJ-640 / 740 / RS-640 / SJ-640 / 1000 / 1045; Mimaki JV3 / JV22, Mutoh VJ-1604 / 1604W  
**OEM**  
**Price: ≤ \$3 / pc**



**ACC-EPS-002: Epson Stylus 9600 / 7600 Damper**  
Used for Epson stylus pro 9600 / 7600  
**OEM**  
**Price: ≤ \$5 / pc**



**ACC-EPS-003: Epson Stylus Photo R1800 / R2400 Pump Assembly**  
Used for Epson Stylus Photo R1800 / R 2400  
**Original**  
**Price: ≤ \$52 / pc**



**ACC-EPS-004: Epson Stylus Pro 4880 Pump Assembly**  
Used for Epson Stylus Pro4000 / 4400 / 4450 / 4880 / 4800  
**Original**  
**Price: ≤ \$130 / pc**



**ACC-EPS-007: Epson 1290 Mainboard (Second-hand)**  
Used for Epson stylus photo 1290  
**Original**  
**Price: ≤ \$41 / pc**



**ACC-EPS-008: Epson 1390 Mainboard (Second-hand)**  
Used for Epson stylus photo 1390  
**Original**  
**Price: ≤ \$94 / pc**



**ACC-EPS-009: Epson R1800 Mainboard**  
Used for Epson stylus photo 1800  
**Original**  
**Price: ≤ \$242 / pc**



**ACC-EPS-010: Epson R2400 Mainboard**  
Used for Epson stylus photo R2400  
**Original**  
**Price: ≤ \$218 / pc**



**ACC-EPS-011: Epson R1390 / R1800 / R2400 Power Board (Second-hand)**  
Used for Epson R1390 / R1800 / R2400  
**Original**  
**Price: ≤ \$49 / pc**



**ACC-EPS-012: Epson Stylus Pro 7880 Cutter Cap**  
Used for Epson Stylus Pro 7400 / 7450 / 7880 / 9880 / 9450 / 9400  
**Original**  
**Price: ≤ \$4 / pc**



**ACC-EPS-013: Epson Stylus Pro4880 Absorbent Sponge**  
Used for Epson Stylus Pro 4000 / 4400 / 4450 / 4880 / 4800  
**Original**  
**Price: ≤ \$58 / pc**



**ACC-EPS-014: Epson 1290 Head Data Cable**  
Used for Epson stylus photo 1290  
**Original**  
**Price: ≤ \$20 / set**



**ACC-EPS-015: Epson R1390 Head Data Cable**  
Used for Epson stylus photo R1390  
**Original**  
**Price: ≤ \$17 / set**



**ACC-EPS-016: Epson DX3 / DX4 Printhead Big Damper with Small Filter**  
Used for Epson DX4 / DX5 head; Roland VP-300 / 540 / XC-540 / XJ-640 / 740 / RS-640 / SJ-640 / 1000 / 1045; Mimaki JV3 / JV22, Mutoh VJ-1604 / 1604W  
**OEM**  
**Price: ≤ \$3 / pc**



**ACC-EPS-017: Epson DX5 Printhead Damper**  
Used for Epson DX5 Head; Epson Stylus Pro 9800 / 9400 / 7800 / 7880 / 7400 / 7450 / 4800 / 4400 / 4000  
**OEM**  
**Price: ≤ \$3 / pc**



**ACC-EPS-018: Epson Stylus Pro 4800 Belt Pulley**  
Used for Epson Stylus Pro4000 / 4400 / 4450 / 4800 / 4880  
**Original**  
**Price: ≤ \$13 / pc**



**ACC-EPS-019: Epson Stylus Pro 4880 Cutter**  
Used for Epson Stylus Pro 4000 / 4400 / 4450 / 4880 / 7400 / 7450 / 7600 / 7880 / 9400 / 9450 / 9600 / 9880  
**Original**  
**Price: ≤ \$26 / pc**



**ACC-EPS-020: Epson Stylus Pro4450 Mainboard**  
Used for Epson Stylus Pro 4450  
**Original**  
**Price: ≤ \$429 / pc**



**ACC-EPS-021: Epson Stylus Pro4800 Mainboard**  
Used for Epson Stylus Pro 4800  
**Original**  
**Price: ≤ \$623 / pc**



**ACC-EPS-022: Epson Stylus Pro4880 Mainboard**  
Used for Epson Stylus Pro 4880  
**Original**  
**Price: ≤ \$437 / pc**



**ACC-EPS-023: Epson Stylus Pro 9800 Mainboard**  
Used for Epson Stylus Pro 9800  
**Original**  
**Price: ≤ \$639 / pc**



**ACC-EPS-024: Epson Stylus Pro7880 Mainboard**  
Used for Epson Stylus Pro 7880  
**Original**  
**Price: ≤ \$623 / pc**



**ACC-EPS-025: Epson R1900 Mainboard**  
Used for Epson R1900  
**Original**  
**Price: ≤ \$52 / pc**



**ACC-EPS-026: Epson Stylus Photo R230 CR Motor**  
Used for Epson Stylus Photo R230  
**Original**  
**Price: ≤ \$24 / pc**



**ACC-EPS-027: Epson Stylus Pro 7600 Encoder Strip**  
Used for Epson Stylus Pro 7600  
**Original**  
**Price: ≤ \$70 / pc**



**ACC-EPS-028: Epson R1400 Mainboard (Second-hand)**  
Used for Epson R1400 Mainboard  
**Original**  
**Price: ≤ \$94 / pc**

## &gt; Printer Spare Parts &gt; Epson printer spare parts



**ACC-EPS-029: Epson Stylus Pro7880 CR Board**  
Used for Epson Stylus Pro7400 / 7450 / 7880 / 9880 / 9450 / 9400  
**Original**  
**Price: ≤ \$52 / pc**



**ACC-EPS-030: Epson Stylus Pro7880 CR Motor**  
Used for Epson Stylus Pro7400 / 7450 / 7880 / 9880 / 9450 / 9400  
**Original**  
**Price: ≤ \$235 / pc**



**ACC-EPS-031: Epson Stylus Pro 7600 / 9600 CR Motor**  
Used for Epson Stylus Pro 7600 / 9600  
**Original**  
**Price: ≤ \$242 / pc**



**ACC-EPS-032: Epson Stylus Pro 7880 Left Board**  
Used for Epson Stylus Pro7450 / 7880 / 9880 / 9450  
**Original**  
**Price: ≤ \$65 / pc**



**ACC-EPS-033: Epson DX5 Printhead Manifold / Adapter**  
Used for Epson DX5 printhead; Epson Stylus Pro 4400 / 4800 / 7400 / 7800 / 9400 / 9800 / 4880 / 9880 / 7880 / 9450 / 3880; Epson Stylus Photo R1800 / R2400  
**Original**  
**Price: ≤ \$79.9 / pc**



**ACC-EPS-034: Epson Stylus Pro 4880 / 4800 CR Belt**  
Used for Epson Stylus Pro4000 / 4400 / 4450 / 4800 / 4880  
**Original**  
**Price: ≤ \$20 / pc**



**ACC-EPS-035: Epson Stylus Pro 9600 / 9800 / 9400 CR Belt**  
Used for Epson Stylus Pro 9000 / 9400 / 9450 / 9600 / 9800 / 9880  
**Original**  
**Price: ≤ \$78 / pc**



**ACC-EPS-036: Epson Stylus Pro 4880 Waste Ink Tank**  
Used for Epson Stylus Pro 4000 / 4400 / 4450 / 4880 / 7400 / 7450 / 7600 / 7880 / 9400 / 9450 / 9600 / 9880  
**Original**  
**Price: ≤ \$37 / pc**



**ACC-EPS-037: Epson Stylus Pro 10000 / 10600 Pump Assembly**  
Used for Epson Stylus Pro 10000 / 10600  
**Original**  
**Price: ≤ \$235 / pc**



**ACC-EPS-038: DX5 Epson SP R1800 / R2400 Water Printhead Manifold / Adapter**  
Used for Epson Stylus Pro 3800 / 3850 / 3890  
**Original**  
**Price: ≤ \$58 / pc**



**ACC-EPS-039: Epson Stylus Pro 3800 / 3850 / 3890 Pump Assembly**  
Used for Epson Stylus Pro 3800 / 3850 / 3890  
**Original**  
**Price: ≤ \$58 / pc**



**ACC-EPS-040: Epson Stylus Photo R1390 / R1400 Pump Assembly**  
Used for Epson Stylus Photo R1390 / R1400 / R1410  
**Original**  
**Price: ≤ \$34 / pc**



**ACC-EPS-041: Epson Stylus Pro 4880 Left Junction Board**  
Used for Epson Stylus Pro4000 / 4400 / 4450 / 4880 / 4800  
**Original**  
**Price: ≤ \$15 / pc**



**ACC-EPS-042: Epson Stylus Pro 4880 Refilling Cartridge**  
Used for Epson Stylus Pro7600 / 9600 / 4000 / 4400 / 4450 / 4800 / 4880  
**OEM**  
**Price: ≤ \$45 / set (8pcs / set)**



**ACC-EPS-043: Epson Stylus Pro 7880 Refilling Cartridge**  
Used for Epson Stylus Pro7400 / 7450 / 7880 / 9880 / 9450 / 9400  
**OEM**  
**Price: ≤ \$52 / set (8pcs / set)**



**ACC-EPS-044: Epson Stylus Pro 4880 / 7880 / 9880 Roller Pulley**  
Used for Epson Stylus Pro4000 / 4400 / 4450 / 4880 / 7400 / 7450 / 7600 / 7880 / 9400 / 9450 / 9600 / 9880  
**Original**  
**Price: ≤ \$22 / pc**



**ACC-EPS-045: Epson Stylus Pro 7880 CR Belt**  
Used for Epson Stylus Pro 7000 / 7400 / 7450 / 7500 / 7600 / 7880  
**Original**  
**Price: ≤ \$53 / pc**



**ACC-EPS-046: Epson Stylus Pro 9880 Wiper**  
Used for Epson Stylus Pro 4000 / 4400 / 4450 / 4880 / 7400 / 7450 / 7880 / 9400 / 9450 / 9880  
**Original**  
**Price: ≤ \$5 / pc**



**ACC-EPS-047: Epson Stylus Pro 7600 Wiper**  
Used for Epson Stylus Pro 7600 / 9600  
**Original**  
**Price: ≤ \$11 / pc**



**ACC-EPS-048: Epson Stylus Color 900 Pump Assembly**  
Used for Epson Stylus Color 900  
**Original**  
**Price: ≤ \$142 / pc**



**ACC-EPS-049: Epson Stylus Pro 7600 / 4880 Width Contact Point**  
Used for Epson Stylus Pro 4000 / 4400 / 4450 / 4880 / 7600 / 9600  
**Original**  
**Price: ≤ \$2 / pc**



**ACC-EPS-050: Epson Stylus Pro 4880 Pulley**  
Used for Epson Stylus Pro4000 / 4400 / 4450 / 4800 / 4880  
**Original**  
**Price: ≤ \$23 / pc**



**ACC-EPS-051: Epson Stylus Photo R2400 Encoder Strip**  
Used for Epson Stylus Photo R1390 / 1800 / 2400 / 1900 / 2000 / ME1100 / C1100  
**Original**  
**Price: ≤ \$6 / pc**



**ACC-EPS-052: Epson Stylus Photo R2100 Pump Accessories**  
Used for Epson Stylus Photo 2100 / 2200  
**Original**  
**Price: ≤ \$21 / pc**



**ACC-EPS-054: Epson Stylus Pro 7600 / 9600 Junction Board**  
Used for Epson Stylus Pro7600 / 9600  
**Original**  
**Price: ≤ \$22 / pc**



**ACC-EPS-055: Epson Stylus Pro 4880 Right Junction Board**  
Used for Epson Stylus Pro4000 / 4400 / 4450 / 4880 / 4800  
**Original**  
**Price: ≤ \$33 / pc**



**ACC-EPS-056: Epson Stylus Pro 7600 / 9600 CR Board**  
Used for Epson Stylus Pro7600 / 9600  
**Original**  
**Price: ≤ \$32 / pc**

## &gt; Printer Spare Parts &gt; Epson printer spare parts



**ACC-EPS-057: Epson Stylus Pro 4880 / 7880 Network Card**  
Used for Epson Stylus Pro 4000 / 4400 / 4450 / 4880 / 7400 / 7450 / 7600 / 7880 / 9400 / 9450 / 9600 / 9880  
**Original**  
**Price: ≤ \$40 / pc**



**ACC-EPS-058: Epson Stylus Pro 4880 Belt Fixing**  
Used for Epson Stylus Pro 4000 / 4400 / 4450 / 4880 / 4880  
**Original**  
**Price: ≤ \$11 / pc**



**ACC-EPS-059: Epson Stylus Pro 4880 CR Shelf**  
Used for Epson Stylus Pro 4000 / 4400 / 4450 / 4880 / 4800  
**Original**  
**Price: ≤ \$40 / set**



**ACC-EPS-060: Epson Stylus Pro 7880 Air Pump**  
Used for Epson Stylus Pro 7400 / 7450 / 7880 / 9880 / 9450 / 9400  
**Original**  
**Price: ≤ \$186 / pc**



**ACC-EPS-061: Epson Stylus Pro 7880 Encoder Sensor Adapter**  
Used for Epson Stylus Pro 7400 / 7450 / 7800 / 7880 / 9880 / 9800 / 9450 / 9400  
**Original**  
**Price: ≤ \$16 / set**



**ACC-EPS-062: Epson Stylus Pro 4880 Cutter Cap**  
Used for Epson Stylus Pro 4000 / 4400 / 4450 / 4880 / 4800  
**Original**  
**Price: ≤ \$19 / pc**



**ACC-EPS-063: Epson Stylus Pro 7880 / 9880 Belt Pulley**  
Used for Epson Stylus Pro 7400 / 7450 / 7600 / 7800 / 7880 / 9400 / 9450 / 9600 / 9800 / 9880  
**Original**  
**Price: ≤ \$19 / pc**



**ACC-EPS-064: Epson Stylus Photo 1290 Pump Accessories**  
Used for Epson Stylus Photo 1290  
**Original**  
**Price: ≤ \$18 / pc**



**ACC-EPS-065: Epson Stylus Pro 9910 Cartridge Contact Point**  
Used for Epson Stylus Pro 7910 / 7700 / 7710 / 9910 / 9900 / 9710 / 11880C  
**Original**  
**Price: ≤ \$2 / pc**



**ACC-EPS-066: Epson Stylus Pro 7450 / 7880 Encoder Strip**  
Used for Epson Stylus Pro 7400 / 7450 / 7880  
**Original**  
**Price: ≤ \$129 / pc**



**ACC-EPS-067: Epson Stylus Pro 7600 / 9600 CR Sensor**  
Used for Epson Stylus Pro 7600 / 9600  
**Original**  
**Price: ≤ \$42 / pc**



**ACC-EPS-068: Epson Stylus Pro 7880 / 9880 Narrow Contact Point**  
Used for Epson Stylus Pro 7400 / 7450 / 7880 / 9400 / 9450 / 9880  
**OEM**  
**Price: ≤ \$2 / pc**



**ACC-EPS-069: Epson Stylus Pro 7910 / 9910 Chip**  
Used for Epson Stylus Pro 7910 / 9910 / 7900 / 9900  
**OEM**  
**Price: ≤ \$5 / pc**



**ACC-EPS-070: Epson Stylus Pro 7880 Chip**  
Used for Epson Stylus Pro 4000 / 4400 / 4450 / 4880 / 7400 / 7450 / 7600 / 7880 / 9400 / 9450 / 9600 / 9880  
**OEM**  
**Price: ≤ \$1 / pc**



**ACC-EPS-071: Epson Stylus Photo R2400 Feed Motor**  
Used for Epson Stylus Photo R800 / 1390 / 1400 / 1800 / 2400 / 1900  
**Original**  
**Price: ≤ \$12 / pc**



**ACC-EPS-072: Epson Stylus Pro 4880 Feed Motor**  
Used for Epson Stylus Pro 4000 / 4400 / 4450 / 4880 / 4800  
**Original**  
**Price: ≤ \$27 / pc**



**ACC-EPS-073: Epson Stylus Photo R1390 CR Motor**  
Used for Epson Stylus Photo R1390 / 1400 / 1900  
**Original**  
**Price: ≤ \$15 / pc**



**ACC-EPS-074: Epson Stylus Photo R2400 CR Motor**  
Used for Epson Stylus Photo R1800 / 2400  
**Original**  
**Price: ≤ \$19 / pc**



**ACC-EPS-075: Epson Stylus Pro 4880 CR Motor**  
Used for Epson Stylus Pro 4450 / 4800 / 4880  
**Original**  
**Price: ≤ \$27 / pc**



**ACC-EPS-076: Epson Stylus Photo R270 CR Motor**  
Used for Epson Stylus Photo R390 / R270 / R260 / T50 / P50 / A50  
**Original**  
**Price: ≤ \$11 / pc**



**ACC-EPS-077: Epson Stylus Photo R270 Media Input Shelf**  
Used for Epson Stylus Photo R270 / 260 / T50 / P50 / A50 / R390  
**Original**  
**Price: ≤ \$12 / pc**



**ACC-EPS-078: Epson Stylus Photo R800 Media Input Shelf**  
Used for Epson Stylus Photo R800  
**Original**  
**Price: ≤ \$19 / pc**



**ACC-EPS-079: Epson Stylus Pro 7880 Damper Shelf**  
Used for Epson Stylus Pro 7400 / 7450 / 7880 / 9880 / 9450 / 9400  
**Original**  
**Price: ≤ \$19 / set**



**ACC-EPS-080: Epson Stylus Pro 4880 Ink Tube**  
Used for Epson Stylus Pro 4000 / 4400 / 4450 / 4880  
**Original**  
**Price: ≤ \$7 / pc (8pcs / set)**



**ACC-EPS-081: Epson Stylus Photo ME2 Media Input Shelf**  
Used for Epson Stylus Photo ME2 / ME200 / ME30 / ME300  
**Original**  
**Price: ≤ \$7 / pc**



**ACC-EPS-082: Epson Stylus Photo R1390 Cartridge Chip Board**  
Used for Epson Stylus Photo R1390 / 1400  
**Original**  
**Price: ≤ \$19 / pc**



**ACC-EPS-083: Epson Stylus Photo R1900 Cartridge Chip Board**  
Used for Epson Stylus Photo R1900  
**Original**  
**Price: ≤ \$21 / pc**

## &gt; Printer Spare Parts &gt; Epson printer spare parts



**ACC-EPS-084: Epson Stylus Pro 4880 CR Sensor**  
Used for Epson Stylus Pro 4000 / 4400 / 4450 / 4880 / 4800  
**Original**  
**Price: ≤ \$19 / pc**



**ACC-EPS-085: Epson Stylus Photo R2400 Pulley Encoder Sensor**  
Used for Epson Stylus Photo R1800 / 2400 / R800  
**Original**  
**Price: ≤ \$11 / pc**



**ACC-EPS-086: Epson Stylus Pro 4880 CR Junction Board**  
Used for Epson Stylus Pro 4000 / 4400 / 4450 / 4880 / 4800  
**Original**  
**Price: ≤ \$11 / pc**



**ACC-EPS-087: Epson Stylus Pro 4880 Pulley Encoder Sensor**  
Used for Epson Stylus Pro 4000 / 4400 / 4450 / 4880 / 7400 / 7450 / 7600 / 7880 / 9400 / 9450 / 9600 / 9880  
**Original**  
**Price: ≤ \$94 / pc**



**ACC-EPS-088: Epson Stylus Pro 3880 Waste Ink Tank**  
Used for Epson Stylus Pro 3800 / 3890 / 3880 / 3850  
**Original**  
**Price: ≤ \$40 / pc**



**ACC-EPS-089: Epson Stylus Pro 4880 Panel Unit**  
Used for Epson Stylus Pro 4000 / 4400 / 4450 / 4880 / 4800  
**Original**  
**Price: ≤ \$68 / pc**



**ACC-EPS-090: Epson Stylus Pro 4880 Junction Board**  
Used for Epson Stylus Pro 4000 / 4400 / 4450 / 4880 / 4800  
**Original**  
**Price: ≤ \$42 / pc**



**ACC-EPS-091: Epson Stylus Pro 7800 Bearing**  
Used for Epson Stylus Pro 7800  
**Original**  
**Price: ≤ \$3 / pc**



**ACC-EPS-092: Epson Stylus Pro 9880 Panel Unit**  
Used for Epson Stylus Pro 7400 / 7450 / 7880 / 9880 / 9450 / 9400  
**Original**  
**Price: ≤ \$218 / pc**



**ACC-EPS-093: Epson ME1100 / C1100 Mainboard**  
Used for Epson ME1100 / C1100  
**Original**  
**Price: ≤ \$74 / pc**



**ACC-EPS-094: Epson Stylus pro 9880 Mainboard**  
Used for Epson Stylus Pro 9880  
**Original**  
**Price: ≤ \$591 / pc**



**ACC-EPS-095: Epson Stylus pro 9910 Mainboard**  
Used for Epson Stylus Pro 9910  
**Original**  
**Price: ≤ \$680 / pc**



**ACC-EPS-096: Epson Stylus pro 7880 Right Board**  
Used for Epson Stylus Pro 7450 / 7880 / 9880 / 9450  
**Original**  
**Price: ≤ \$65 / pc**



**ACC-EPS-097: Epson Stylus Pro 7880 CR Sensor**  
Used for Epson Stylus Pro 7400 / 7450 / 7880 / 9880 / 9450 / 9400  
**Original**  
**Price: ≤ \$39 / pc**



**ACC-EPS-098: Epson Stylus pro 7600 Long Data Cable**  
Used for Epson Stylus pro 7600 / 9600  
**Original**  
**Price: ≤ \$65 / set (3pcs / set)**



**ACC-EPS-099: Epson Stylus Pro 7880 Ink Tank Valve Assy**  
Used for Epson Stylus Pro 4000 / 7400 / 7450 / 7880 / 7800 / 9800 / 9880 / 9450 / 9400  
**Original**  
**Price: ≤ \$14 / pc**



**ACC-EPS-100: Epson Stylus Photo EX3 CR Adapter**  
Used for Epson Stylus Photo EX3  
**Original**  
**Price: ≤ \$14 / pc**



**ACC-EPS-101: Epson Stylus Pro 7880 Pinch Roller Unit**  
Used for Epson Stylus Pro 7400 / 7450 / 7880 / 9880 / 9450 / 9400  
**Original**  
**Price: ≤ \$14 / pc**



**ACC-EPS-102: Epson Stylus Pro 9600 Lever Release**  
Used for Epson Stylus Pro 7600 / 9600  
**Original**  
**Price: ≤ \$15 / pc**



**ACC-EPS-103: Epson Stylus Pro 9880 Ink Tank Lever**  
Used for Epson Stylus Pro 7400 / 7450 / 7880 / 9880 / 9450 / 9400  
**Original**  
**Price: ≤ \$11 / pc**



**ACC-EPS-104: Epson Stylus Photo R2400 Encoder Pulley**  
Used for Epson Stylus Photo R1390 / 1800 / 2400 / 1900 / 2000 / ME1100 / C1100  
**Original**  
**Price: ≤ \$9 / pc**



**ACC-EPS-105: Epson Stylus Pro 7600 Power Board (Second-hand)**  
Used for Epson Stylus Pro 7600 / 9600  
**Original**  
**Price: ≤ \$45 / pc**



**ACC-EPS-106: Epson Stylus Pro 4880 T Shape Board**  
Used for Epson Stylus Pro 4000 / 4400 / 4450 / 4880 / 7400 / 7450 / 9400 / 9450 / 9880 / 788 / 7600 / 9600  
**Original**  
**Price: ≤ \$3 / pc**



**ACC-EPS-107: Epson Stylus Pro 9880 T Shape Board**  
Used for Epson Stylus Pro 4000 / 4400 / 4450 / 4880 / 7400 / 7450 / 9400 / 9450 / 9880 / 7880  
**Original**  
**Price: ≤ \$3 / pc**



**ACC-EPS-109: Epson Stylus Pro 4880 Cap Top**  
Used for Epson Stylus Pro 4880 / 4800  
**OEM**  
**Price: ≤ \$17 / pc**



**ACC-EPS-110: Epson Stylus Pro 7880 Cap Top**  
Used for Epson Stylus Pro 7400 / 7450 / 7800 / 7880 / 9400 / 9450 / 9800 / 9880  
**OEM**  
**Price: ≤ \$17 / pc**



**ACC-EPS-111: Epson Stylus Pro 10000 Cartridge with Chip**  
Used for Epson Stylus Pro 10000  
**OEM**  
**Price: ≤ \$23 / pc**

## &gt; Printer Spare Parts &gt; Epson printer spare parts



**ACC-EPS-112: Epson DX2 Printhead Small Damper**  
Used for Epson DX2 Head, Epson stylus color 3000; Epson 1290 / 1390; Mimaki JV2; Mutoh RJ-6000 / 6100 / 4000.  
**OEM**  
**Price: ≤ \$3 / pc**



**ACC-EPS-113: Epson Stylus Pro 7910 Pump Assembly**  
Used for Epson Stylus Pro 7910 / 9910 / 7908 / 9908  
**Original**  
**Price: ≤ \$259 / pc**



**ACC-EPS-114: Epson Stylus Pro 7910 Damper**  
Used for Epson Stylus Pro 7910 / 9910 / 7908 / 9908  
**Original**  
**Price: ≤ \$170 / set**



**ACC-EPS-115: Epson Stylus Pro 7710 Damper**  
Used for Epson Stylus Pro 7710 / 9710  
**Original**  
**Price: ≤ \$100 / set**



**ACC-EPS-116: Epson Stylus Pro 7910 Power Board**  
Used for Epson Stylus Pro 7910 / 9910 / 7908 / 9908  
**Original**  
**Price: ≤ \$159 / pc**



**ACC-EPS-117: Epson Stylus Pro 7880 Power Board**  
Used for Epson Stylus Pro 7880 / 9880 / 7800 / 9800  
**Original**  
**Price: ≤ \$340 / pc**



**ACC-EPS-118: Epson Stylus Pro 4880 Power Board**  
Used for Epson Stylus Pro 4880 / 4800 / 4450  
**Original**  
**Price: ≤ \$138 / pc**



**ACC-EPS-119: Epson Stylus Pro 7908 Refilling Cartridge**  
Used for Epson Stylus Pro 7908 / 9908 / 7890 / 9890 / 11880C  
**OEM**  
**Price: ≤ \$109 / set (9pcs / set)**



**ACC-EPS-120: Epson Stylus Pro 7710 / 9710 Refilling Cartridge**  
Used for Epson Stylus Pro 7710 / 9710 / 7700 / 9700  
**OEM**  
**Price: ≤ \$61 / set (5pcs / set)**



**ACC-EPS-121: Epson 4910 Maintenance Box**  
Used for Epson Stylus Pro 4910  
**Original**  
**Price: ≤ \$39 / pc**



**ACC-EPS-122: Epson Stylus Pro 7450 Mainboard**  
Used for Epson Stylus Pro 7450  
**Original**  
**Price: ≤ \$642 / pc**



**ACC-EPS-123: Epson Stylus Pro 9450 Mainboard**  
Used for Epson Stylus Pro 9450  
**Original**  
**Price: ≤ \$566 / pc**



**ACC-EPS-124: Epson Stylus Pro 4910 / 4900 Refilling Cartridge**  
Used for Epson Stylus Pro 4910 / 4900  
**OEM**  
**Price: ≤ \$14 / pc**



**ACC-EPS-125: Epson Stylus Photo R800 Power Board**  
Used for Epson Stylus Photo R800  
**Original**  
**Price: ≤ \$45 / pc**



**ACC-EPS-126: Epson Stylus Photo R1800 / 1900 Head Cable**  
Used for Epson Stylus Photo R1800 / 1900  
**Original**  
**Price: ≤ \$11 / set**



**ACC-EPS-127: Epson Stylus Pro 7910 / 9910 Refilling Cartridge**  
Used for Epson Stylus Pro 7910 / 9910 / 7900 / 9900  
**OEM**  
**Price: ≤ \$133 / set (11pcs / set)**



**ACC-EPS-128: Epson Stylus Pro 7710 / 9710 Chip**  
Used for Epson Stylus Pro 7710 / 9710 / 7700 / 9700  
**OEM**  
**Price: ≤ \$5 / pc**



**ACC-EPS-129: Epson Stylus Pro 7908 / 9908 Chip**  
Used for Epson Stylus Pro 7908 / 9908 / 7890 / 9890 / 11880C  
**OEM**  
**Price: ≤ \$5 / pc**



**ACC-EPS-130: Epson 1390 Refilling Cartridge**  
Used for Epson Stylus Photo R1390  
**OEM**  
**Price: ≤ \$22 / set**



**ACC-EPS-131: Epson 7800 / 9800 Head Data Cable**  
Used for Epson Stylus Pro 7800 / 9800 / 7400 / 9400  
**OEM**  
**Price: ≤ \$9 / set (2pcs / set)**



**ACC-EPS-132: Epson 7800 / 9800 Long Data Cable**  
Used for Epson Stylus Pro 7800 / 9800 / 7400 / 9400  
**OEM**  
**Price: ≤ \$42 / set (3pcs / set)**



**ACC-EPS-133: Epson Stylus Pro 7880 Ink Tube**  
Used for Epson Stylus Pro 7400 / 7450 / 7600 / 7880  
**Original**  
**Price: ≤ \$87 / set (8pcs / set)**



**ACC-EPS-134: Epson Stylus Pro 9880 Ink Tube**  
Used for Epson Stylus Pro 9400 / 9450 / 9600 / 9880  
**Original**  
**Price: ≤ \$105 / set (8pcs / set)**



**ACC-EPS-135: Epson 2400 Cable Card 5pin**  
Used for Epson 2400  
**Original**  
**Price: ≤ \$5 / pc**



**ACC-EPS-138: Epson 1900 Paper Sensor**  
Used for Epson 1900  
**Original**  
**Price: ≤ \$5 / pc**



**ACC-EPS-139: Epson 1390 CSIC FFC**  
Used for Epson 1390  
**Original**  
**Price: ≤ \$8 / pc**



**ACC-EPS-140: Epson 7800 Paper Edge Sensor**  
Used for Epson 7800 / 9800  
**Original**  
**Price: ≤ \$33 / pc**



**ACC-EPS-141: Epson 7800 Ink Mark Sensor Board**  
Used for Epson 7800  
**Original**  
**Price: ≤ \$27 / pc**

## &gt; Printer Spare Parts &gt; Epson printer spare parts



**ACC-EPS-142: Epson 7800 Panel Cable**  
Used for Epson 7800  
**Original**  
**Price: ≤ \$12 / pc**



**ACC-EPS-143: Epson 7800 Main Board**  
Used for Epson 7800  
**Original**  
**Price: ≤ \$442 / pc**



**ACC-EPS-144: Chip Resetter for Epson 9800**  
Used for 7600 / 9600 / 4000 / 4400 / 4800 / 4880 / 4450 / 7400 / 7450 / 7800 / 7880 / 9800 / 9880 / 9400 / 9450  
**OEM**  
**Price: ≤ \$7 / pc**



**ACC-EPS-145: Epson 1390 Refilling Cartridge**  
Used for Epson 1390  
**OEM**  
**Price: ≤ \$15 / pc**



**ACC-EPS-146: Epson 1390 Carriage**  
Used for Epson 1390  
**Original**  
**Price: ≤ \$50 / pc**



**ACC-EPS-147: Chip Resetter for Epson 7700 / 9700 / 7710 / 9710**  
Used for 7700 / 9700 / 7710 / 9710 / 7890 / 9890  
**OEM**  
**Price: ≤ \$16 / pc**



**ACC-EPS-148: Epson PRO7880 Box ASSY Flushing - 1305746**  
Used for Epson Stylus Pro 7400 / 7450 / 7800 / 7880 / 9400 / 9450 / 9800 / 9880  
**Original**  
**Price: ≤ \$43 / pc**



**ACC-EPS-150: Epson 7880 CSIC FFC**  
Used for Epson Stylus Pro9880 / 9800 / 9400 / 9450 / 7450 / 7400 / 7800 / 7880  
**OEM**  
**Price: ≤ \$5 / pc**



**ACC-EPS-151: Epson Stylus Pro 4880 Ink Tank Valve Assy**  
Used for Epson Stylus Pro4000 / 4400 / 4450 / 4880 / 4800  
**Original**  
**Price: ≤ \$14 / pc**



**ACC-EPS-152: Epson PM210 CISS Kit**  
Used for Epson PM210 / PM250 / PM270 / PM310 / PM410 / PM235  
**OEM**  
**Price: ≤ \$13 / pc**



**ACC-EPS-153: Epson DX7 Damper**  
Used for Epson DX7 Damper  
**OEM**  
**Price: ≤ \$5 / pc**



**ACC-EPS-154: Epson Stylus Photo R2400 Carriage Unit**  
Used for Epson Stylus Photo R2400  
**Original**  
**Price: ≤ \$68 / pc**



**ACC-EPS-155: Epson 2400 Cable Card 15pin**  
Used for Epson Stylus Photo R2400  
**Original**  
**Price: ≤ \$5 / pc**



**ACC-EPS-156: Epson Stylus Photo 4880 Encoder Strip**  
Used for Epson Stylus Photo 4880 / 4400 / 4450 / 4800  
**Original**  
**Price: ≤ \$15 / pc**



**ACC-EPS-157: Epson Stylus pro 9600 Long Data Cable**  
Used for Epson Stylus pro 9600  
**Original**  
**Price: ≤ \$68 / set (3pcs / set)**



**ACC-EPS-158: Resize Adapter for Epson DX4 Printhead Big Damper**  
Used for Epson DX3 / DX4 / DX5 head; Roland FJ-740 / 540 / VP-300 / 540 / XC-540 / XJ-640 / XJ-740 / RS-640, SJ-740 / 540 / 640 / 1000 / 1045ex; Mimaki JV3 / JV4 / JV22, Mutoh VJ-1204 / 1304 / 1604 / 1604W / RJ-900C  
**OEM**  
**Price: ≤ \$2 / pc**



**ACC-EPS-159: Epson DX5 Printhead Damper UV**  
Used for Epson DX5 Head; Epson Stylus Pro 9800 / 9400 / 7800 / 7880 / 7400 / 7450 / 4800 / 4400 / 4000  
**OEM**  
**Price: ≤ \$6 / pc**



**ACC-EPS-163: New Style Roland XC - 540 Big Damper with Small Filter**  
Used for Used for Epson DX4 / DX5 head; Roland VP-300 / 540 / XC-540 / XJ-640 / 740 / RS-640 / SJ-640 / 1000 / 1045; Mimaki JV3 / JV22, Mutoh VJ-1604 / 1604W  
**OEM**  
**Price: ≤ \$4 / pc**



**ACC-EPS-164: Epson Stylus Pro 7600 / 9600 Refilling Cartridge**  
Used for Epson Stylus pro7600 / 9600  
**OEM**  
**Price: ≤ \$53 / set (7pcs / set)**



**ACC-EPS-165: Epson Stylus Pro 4400 / 4450 Refilling Cartridge**  
Used for Epson Stylus pro4400 / 4450  
**OEM**  
**Price: ≤ \$30 / set (4pcs / set)**



**ACC-EPS-166: Epson Stylus Pro 4400 / 4450 UV Refilling Cartridge**  
Used for Epson Stylus pro4400 / 4450  
**OEM**  
**Price: ≤ \$33 / set (4pcs / set)**



**ACC-EPS-167: Epson Stylus Pro 4880 UV Ink Tube, 3.6mm x 2.6mm**  
Used for Epson DX5 Head; Epson Stylus Pro 9800 / 9400 / 7800 / 7880 / 7400 / 7450 / 4800 / 4400 / 4000  
**OEM**  
**Price: ≤ \$3 / pc**



**ACC-EPS-168: Epson DX4/DX5 Printhead Big Damper UV**  
Used for Epson DX4 / DX5 head; Roland VP-300 / 540 / XC-540 / XJ-640 / 740 / RS-640 / SJ-640 / 1000 / 1045; Mimaki JV3 / JV22, Mutoh VJ-1604 / 1604W  
**OEM**  
**Price: ≤ \$3 / pc**



**ACC-EPS-169: Epson DX7 Damper UV**  
Used for EPSON DX7  
**OEM**  
**Price: ≤ \$6 / pc**



**ACC-EPS-170: Mutoh VJ - 1618 Damper UV**  
Used for Mutoh VJ - 1618  
**OEM**  
**Price: ≤ \$7 / pc**



**ACC-EPS-171: Epson Stylus Pro 9900 Right Ink Tank Assy**  
Used for Epson Stylus Pro 9900 / 9910 / 7910 / 9710 / 7710  
**Original**  
**Price: ≤ \$242 / pc**



## &gt; Printer Spare Parts &gt; Epson printer spare parts



**ACC-EPS-172: Epson Stylus Pro 4000 Refilling Cartridge**  
Used for Epson Stylus Pro 4000  
**OEM**  
**Price: ≤ \$60 / set (8pcs / set)**



**ACC-EPS-173: Epson Stylus Pro 4000 Chip**  
Used for Epson Stylus Pro 4000  
**OEM**  
**Price: ≤ \$9 / set (8pcs / set)**



**ACC-EPS-174: Epson Stylus Pro 7450 / 9450 Refilling Cartridge**  
Used for Epson Stylus Pro 7450 / 9450  
**OEM**  
**Price: ≤ \$60 / set (8pcs / set)**



**ACC-EPS-175: Epson Stylus Pro 7600 Ink Tank Valve Assy**  
Used for Epson Stylus pro7600 / 9600  
**Original**  
**Price: ≤ \$17 / pc**



**ACC-EPS-176: Epson DX7 Printhead F189010 Manifold / Adapter Original**  
Used for Epson DX7 Printhead, B-310 / B-510DN / B-500DN / B-300  
**Original**  
**Price: ≤ \$50 / pc**



**ACC-EPS-177: Epson Stylus Pro 7600 / 9600 Chip**  
Used for Epson Stylus Pro 7600 / 9600  
**OEM**  
**Price: ≤ \$8 / set (7pcs / set)**



**ACC-EPS-178: Epson Stylus Pro 4800 Chip**  
Used for Epson Stylus Pro 4800 Chip  
**OEM**  
**Price: ≤ \$9 / set (8pcs / set)**



**ACC-EPS-179: Epson Stylus Pro 7800/9800 Refilling Cartridge**  
Used for Epson Stylus Pro7800 / 9800  
**OEM**  
**Price: ≤ \$60 / set (8pcs / set)**



**ACC-EPS-180: Epson Stylus Pro 7400 / 9400 Refilling Cartridge**  
Used for Epson Stylus Pro 7400 / 9400  
**OEM**  
**Price: ≤ \$60 / set (8pcs / set)**



**ACC-EPS-181: Epson Stylus Pro 4800 Refilling Cartridge**  
Used for Epson Stylus Pro 4800  
**OEM**  
**Price: ≤ \$60 / set (8pcs / set)**



**ACC-EPS-182: Epson Stylus Pro 7880 Chip**  
Used for Epson Stylus Pro 7880 / 9880  
**OEM**  
**Price: ≤ \$9 / set (8pcs / set)**



**ACC-EPS-183: Epson Stylus Pro 7800 Chip**  
Used for Epson Stylus Pro 7800 / 9800  
**OEM**  
**Price: ≤ \$9 / set (8pcs / set)**



**ACC-EPS-185: Epson Stylus Photo R230 CISS Kit**  
Used for Epson Stylus Photo R230  
**Original**  
**Price: ≤ \$17 / set**



**ACC-EPS-187: Epson Stylus Photo R1390 / 1800 / 1900 Belt Pulley**  
Used for Epson Stylus Photo R1390 / 1800 / 1900  
**Original**  
**Price: ≤ \$5 / pc**



**ACC-EPS-189: Epson Stylus Photo 1290 Encoder Strip**  
Used for Epson Stylus Photo 1290  
**Original**  
**Price: ≤ \$13 / pc**



**ACC-EPS-190: Epson Stylus Pro 9000 Main Board - Second Hand**  
Used for Epson Stylus Pro 9000  
**Original**  
**Price: ≤ \$350 / pc**



**ACC-EPS-191: Epson Stylus Photo R2400 Capping Unit**  
Used for Epson Stylus Photo R2400 / 1900 / 1800 / 2000  
**Original**  
**Price: ≤ \$22 / pc**



**ACC-EPS-192: Epson Stylus Pro 4800 Bearing**  
Used for Epson Stylus Pro 4800  
**Original**  
**Price: ≤ \$4 / pc**



**ACC-EPS-193: Epson Stylus Pro 4910 Pump Assembly**  
Used for Epson Stylus Pro 4910 / 4900  
**Original**  
**Price: ≤ \$275 / pc**



**ACC-EPS-194: Epson Stylus Pro 4910 Waste Ink Tank Sensor**  
Used for Epson Stylus Pro 4910 / 4900 / B310  
**OEM**  
**Price: ≤ \$33 / pc**



**ACC-EPS-195: Epson Stylus Pro 3890 Panel Unit - 1518585**  
Used for Epson Stylus Pro 3890 / 3880 / 3885 / 3800  
**Original**  
**Price: ≤ \$70 / pc**



**ACC-EPS-196: Epson Stylus Pro 3890 Carriage - 1451559**  
Used for Epson Stylus Pro 3890 / 3880 / 3885 / 3800  
**Original**  
**Price: ≤ \$70 / pc**



**ACC-EPS-197: Epson Stylus Pro 7910 Carriage Board - 2128961**  
Used for Epson Stylus Pro 7910 / 9910 / 7908  
**Original**  
**Price: ≤ \$43 / pc**



**ACC-EPS-198: Epson Stylus Pro 7910 Right Junction Board - 2132674**  
Used for Epson Stylus Pro 7910 / 9910 / 7908  
**Original**  
**Price: ≤ \$70 / pc**



**ACC-EPS-199: Epson Stylus Pro 4910 Damper - 1580221**  
Used for Epson Stylus Pro 4910 / 4900  
**Original**  
**Price: ≤ \$160 / pc**



**ACC-EPS-200: Epson Stylus Pro 7910 Left Junction Board - 2119912**  
Used for Epson Stylus Pro 7910 / 9910 / 7908  
**Original**  
**Price: ≤ \$70 / pc**



**ACC-EPS-201: Epson Stylus Pro 4910 Chip Resetter**  
Used for Epson Stylus Pro 4910 / 4900  
**Original**  
**Price: ≤ \$33 / pc**



**ACC-EPS-202: Epson Stylus Pro 7910 Ink Tube Left**  
Used for Epson Stylus Pro 7910 / 9910 / 9908 / 9710 / 7710  
**Original**  
**Price: ≤ \$147 / pc**

## &gt; Printer Spare Parts &gt; Epson printer spare parts



**ACC-EPS-203: Epson Stylus Pro 7910 Ink Tube Right**  
Used for Epson Stylus Pro 7910 / 9910 / 9908 / 9710 / 7710  
**Original**  
**Price: ≤ \$147 / pc**



**ACC-EPS-204: Epson Stylus Pro 3890 Head Data Cable - 1530351, 34 pin**  
Used for Epson Stylus Pro 3890 / 3880 / 3885 / 3800  
**Original**  
**Price: ≤ \$47 / pc**



**ACC-EPS-205: Epson Stylus Pro 7910 Flat Cable CN200 - 34 pin**  
Used for Epson Stylus Pro 7910 / 9910 / 9908 / 9710 / 7710  
**Original**  
**Price: ≤ \$37 / pc**



**ACC-EPS-206: Epson Stylus Pro 7910 Flat Cable CN300 - 34 pin**  
Used for Epson Stylus Pro 7910 / 9910 / 9908 / 9710 / 7710  
**Original**  
**Price: ≤ \$37 / pc**



**ACC-EPS-207: Epson Stylus Pro 7910 Flat Cable CN500 - 34 pin**  
Used for Epson Stylus Pro 7910 / 9910 / 9908 / 9710 / 7710  
**Original**  
**Price: ≤ \$37 / pc**



**ACC-EPS-208: Epson Stylus Pro 7910 Flat Cable CN400 - 34 pin**  
Used for Epson Stylus Pro 7910 / 9910 / 9908 / 9710 / 7710  
**Original**  
**Price: ≤ \$37 / pc**



**ACC-EPS-209: Epson Stylus Pro 7910 Flat Cable CN201 - 34 pin**  
Used for Epson Stylus Pro 7910 / 9910 / 9908 / 9710 / 7710  
**Original**  
**Price: ≤ \$63 / pc**



**ACC-EPS-210: Epson Stylus Pro 7910 Belt - 1587842**  
Used for Epson Stylus Pro 7910 / 9910 / 9908 / 9710 / 7710  
**Original**  
**Price: ≤ \$70 / pc**



**ACC-EPS-211: Epson Stylus Pro 3890 / 3880 / 3885 / 3800 Damper**  
Used for Epson Stylus Pro 3890 / 3880 / 3885 / 3800  
**Original**  
**Price: ≤ \$147 / pc**



**ACC-EPS-212: Epson Stylus Pro GS6000 Box ASSY Flushing - 1496375**  
Used for Epson Stylus Pro GS6000  
**Original**  
**Price: ≤ \$135 / pc**



**ACC-EPS-213: Epson Stylus Pro 10600 Encoder Strip - 1060844**  
Used for Epson Stylus Pro 10600  
**Original**  
**Price: ≤ \$70 / pc**



**ACC-EPS-214: Epson Stylus Pro 11880C Encoder Strip - 1518669**  
Used for Epson Stylus Pro 11880C  
**Original**  
**Price: ≤ \$70 / pc**



**ACC-EPS-215: Epson Stylus Pro GS6000 Steel Belt - 1496335**  
Used for Epson Stylus Pro GS6000  
**Original**  
**Price: ≤ \$105 / pc**

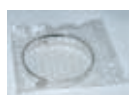

**ACC-EPS-216: Epson Stylus Pro 11880C Steel Belt - 1473676**  
Used for Epson Stylus Pro 11880C  
**Original**  
**Price: ≤ \$130 / pc**

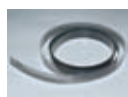

**ACC-EPS-217: Epson Stylus Pro GS6000 Encoder Strip**  
Used for Epson Stylus Pro GS6000  
**Original**  
**Price: ≤ \$113 / pc**



**ACC-EPS-218: Epson Stylus Pro GS6000 Encoder Strip Sensor - 2123061**  
Used for Epson Stylus Pro GS6000  
**Original**  
**Price: ≤ \$88 / pc**



**ACC-EPS-219: Epson Stylus Pro GS6000 CR Motor - 2122763**  
Used for Epson Stylus Pro GS6000  
**Original**  
**Price: ≤ \$267 / pc**



**ACC-EPS-220: Epson Stylus Pro 4880 L - Tube**  
Used for Epson Stylus Pro 4880  
**Original**  
**Price: ≤ \$5 / pc**



**ACC-EPS-221: Epson Stylus Pro 4880 Gear Assy.**  
Used for Epson Stylus Pro 4880  
**Original**  
**Price: ≤ \$47 / pc**



**ACC-EPS-222: Epson Stylus Photo 1290 Wiper**  
Used for Epson Stylus Photo 1290  
**Original**  
**Price: ≤ \$13 / pc**



**ACC-EPS-223: Epson Stylus Pro GS6000 Two Way Valve Assy**  
Used for Epson Stylus Pro GS6000  
**Original**  
**Price: ≤ \$263 / pc**



**ACC-EPS-224: Epson Stylus Pro 7880 / 9880 L - Tube**  
Used for Epson Stylus Pro 7880 / 9880  
**Original**  
**Price: ≤ \$5 / pc**



**ACC-EPS-225: Epson Stylus Pro 7898 Head Lever**  
Used for Epson Stylus Pro 7898  
**Original**  
**Price: ≤ \$15 / pc**



**ACC-EPS-226: EpsonDX6 Capping Unit**  
Used for EPSON DX6  
**Original**  
**Price: ≤ \$108 / pc**



**ACC-EPS-227: Epson 7600 Panel Cable - 16 pin**  
Used for Epson 7600 / 9600  
**Original**  
**Price: ≤ \$10 / pc**



**ACC-EPS-229: Epson Stylus Pro 7800 Encoder Pulley**  
Used for Epson Stylus Pro7800  
**Original**  
**Price: ≤ \$23 / pc**



**ACC-EPS-230: Epson Stylus Photo R2000 Cartridge Chip Board (CSIC)**  
Used for Epson Stylus Photo R2000  
**Original**  
**Price: ≤ \$17 / pc**



**ACC-EPS-231: Epson Stylus Pro 7000 Refilling Cartridge - 220ml**  
Used for Epson Stylus Pro 7000 / 9000 / 7500 / 9500  
**OEM**  
**Price: ≤ \$48 / set (6pcs / set)**

## &gt; Printer Spare Parts &gt; Epson printer spare parts



**ACC-EPS-233: Epson Stylus Pro GS6000 Pump Assembly**  
Used for Epson Stylus Pro GS6000  
**Original**  
**Price: ≤ \$525 / pc**



**ACC-EPS-234: Epson Stylus Pro 9700 Main Board**  
Used for Epson Stylus Pro 9700  
**Original**  
**Price: ≤ \$633 / pc**



**ACC-EPS-235: Epson Stylus Pro 7700 Maintenance Box**  
Used for Epson Stylus Pro 7910 / 9910 / 9908 / 9710 / 7710  
**Original**  
**Price: ≤ \$35 / pc**



**ACC-EPS-236: Epson Stylus Pro 3000 / 5000 / 7000 Maintenance Box**  
Used for Epson Stylus Pro 3000 / 5000 / 7000  
**Original**  
**Price: ≤ \$60 / pc**



**ACC-EPS-237: Epson Stylus Pro 7700 Main Board**  
Used for Epson Stylus Pro 7700  
**Original**  
**Price: ≤ \$600 / pc**



**ACC-EPS-238: Epson Stylus Pro 11880C Main Board**  
Used for Epson Stylus Pro 11880C  
**Original**  
**Price: ≤ \$1267 / pc**



**ACC-EPS-239: Epson Stylus Photo R1900 / R2000 / R2880 Pump Assembly**  
Used for Epson Stylus Photo R1900 / R2000 / R2880  
**Original**  
**Price: ≤ \$47 / pc**



**ACC-EPS-240: Epson SC-T3000 / T3050 / T3070 / T3080 / T5000 / T7000 / T5080 / T7080 Roller Pulley**  
Used for EPSON SC-T3000 / T3050 / T3070 / T3080 / T5000 / T7000 / T5080 / T7080  
**Original**  
**Price: ≤ \$117 / pc**



**ACC-EPS-241: Epson Stylus Pro 10000 / 10000CF / 10600 Steel Belt**  
Used for EPSON STYLUS PRO 10000/10000CF/10600  
**Original**  
**Price: ≤ \$53 / pc**



**ACC-EPS-242: Epson 4880 / 4000 Head Data Cable - 31 pins (2pc), 30 pins (1pc), 110cm Long**  
Used for Epson Stylus pro 4880 / 4800  
**Original**  
**Price: ≤ \$37 / pc**



**ACC-EPS-243: Epson Stylus Pro4880 Ink Tank Assy.**  
Used for Epson Stylus pro4880 / 4800 / 4400  
**Original**  
**Price: ≤ \$97 / pc**



**ACC-EPS-244: Epson Stylus Pro 9700 Waste Ink Tank Sensor**  
Used for Epson Stylus Pro 7700 / 9700 / 7710 / 9710  
**Original**  
**Price: ≤ \$16 / pc**



**ACC-EPS-245: Epson Stylus Pro 11880 Capping Assy**  
Used for Epson Stylus Pro 11880  
**Original**  
**Price: ≤ \$367 / pc**



**ACC-EPS-249: Epson Stylus Pro 7880 Cutter Solenoid Spring**  
Used for Epson Stylus Pro 7880  
**Original**  
**Price: ≤ \$80 / pc**



**ACC-EPS-250: Epson Stylus Photo R2400 / 1800 Cartridge Chip Board (CSIC)**  
Used for Epson Stylus Photo R2400 / 1800  
**Original**  
**Price: ≤ \$15 / pc**



**ACC-EPS-251: Epson Pro - GS6000 Wiper Assy. - 1494558 811**  
Used for Epson PRO GS6000  
**Original**  
**Price: ≤ \$103 / pc**



**ACC-EPS-252: Epson S30680 / 50680 Damper Assy. - 1614491**  
Used for Epson SureColor S30680 / S50680  
**Original**  
**Price: ≤ \$93 / pc**



**ACC-EPS-253: Epson S30680 / 50680 Pump Assy.**  
Used for Epson SureColor S30680 / S50680  
**Original**  
**Price: ≤ \$500 / pc**



**ACC-EPS-254: Epson 10600 Carriage - Second Hand**  
Used for Epson 10600  
**Original**  
**Price: ≤ \$225 / pc**



**ACC-EPS-255: Epson 10600 Carriage Brand New**  
Used for Epson 10600  
**Original**  
**Price: ≤ \$625 / pc**



**ACC-EPS-256: Epson S30680 / 50680 / 70680 / F7080 / B7080 Encoder Strip -1574120**  
Used for Epson SureColorS30680 / 50680 / 70680 / F7080 / B7080  
**Original**  
**Price: ≤ \$133 / pc**



**ACC-EPS-258: Epson S30680 Damper Assy. Left - 1614370**  
Used for Epson SureColor S30680  
**Original**  
**Price: ≤ \$170 / pc**



**ACC-EPS-259: Epson S50680 Damper Assy. Right - 1614369**  
Used for Epson SureColor S50680  
**Original**  
**Price: ≤ \$170 / pc**



**ACC-EPS-260: Epson T3080 / 5080 / 7080 Damper Assy. - 1588043**  
Used for Epson T3080 / 5080 / 7080  
**Original**  
**Price: ≤ \$122 / pc**



**ACC-EPS-261: Epson B6080 Damper Assy. - 1608422**  
Used for Epson SureColor B6080  
**Original**  
**Price: ≤ \$133 / pc**



**ACC-EPS-262: Epson F6080 Damper Assy. - 1604244**  
Used for Epson SureColor F6080  
**Original**  
**Price: ≤ \$113 / pc**



**ACC-EPS-263: Epson F6080 / B6080 Pump Assy. - 1615868**  
Used for Epson SureColor F6080 / B6080  
**Original**  
**Price: ≤ \$153 / pc**

## &gt; Printer Spare Parts &gt; Epson printer spare parts

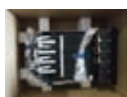

**ACC-EPS-264: Epson S30680 Ink Tank Assy - 1574103**  
Used for Epson SureColor S30680  
**Original**  
**Price: ≤ \$575 / pc**



**ACC-EPS-265: Epson R230 / 220 Pump**  
Used for Epson R230 / 220  
**Original**  
**Price: ≤ \$27 / pc**



**ACC-EPS-266: Epson R3000 Head Data Cable**  
Used for Epson R3000  
**Original**  
**Price: ≤ \$27 / pc**



**ACC-EPS-267: Epson R220 Head Data Cable**  
Used for Epson R220  
**Original**  
**Price: ≤ \$15 / pc**



**ACC-EPS-268: Epson Sure Color T3080 Refilling Cartridge**  
Used for Epson SureColor T3080 / T5080 / T7080 / S30680 / S50680  
**Original**  
**Price: ≤ \$92 / set (5pcs / set)**



**ACC-EPS-273: Epson SureColor S70680 Refilling Cartridge**  
Used for Epson SureColor S70680  
**Original**  
**Price: ≤ \$183 / set (10pcs / set)**



**ACC-EPS-274: Epson Stylus Pro3880 Refilling Cartridge**  
Used for Epson Stylus Pro 3890 / 3880 / 3885 / 3800 / 3850  
**Original**  
**Price: ≤ \$86 / set (9pcs / set)**



**ACC-EPS-275: Epson Stylus Pro3880 CR Motor**  
Used for Epson Stylus Pro 3890 / 3880 / 3885 / 3800 / 3850  
**Original**  
**Price: ≤ \$35 / pc**



**ACC-EPS-276: Epson Stylus Pro3880 Power Board**  
Used for Epson Stylus Pro 3890 / 3880 / 3885 / 3800 / 3850  
**Original**  
**Price: ≤ \$43 / pc**



**ACC-EPS-277: Epson Stylus Pro3880 CR Belt**  
Used for Epson Stylus Pro 3890 / 3880 / 3885 / 3800 / 3850  
**Original**  
**Price: ≤ \$17 / pc**



**ACC-EPS-278: Epson Stylus Pro3880 Encoder Strip**  
Used for Epson Stylus Pro 3890 / 3880 / 3885 / 3800 / 3850  
**Original**  
**Price: ≤ \$17 / pc**



**ACC-EPS-279: Epson Stylus Pro3880 MianBoard**  
Used for Epson Stylus Pro 3890 / 3880 / 3885 / 3800 / 3850  
**Original**  
**Price: ≤ \$292 / pc**



**ACC-EPS-284: Epson 7700/7710 Printhead Manifold / Adapter**  
**Original**  
Used for Epson Stylus Pro 9910 / 7910 / 7890 / 7908 / 9908 / 9890 / 7900 / 9900 / 9700 / 7700 / 9710 / 7710  
**Original**  
**Price: ≤ \$79 / pc**

## &gt; Printer Spare Parts &gt; Roland printer spare parts



**ACC-ROL-001: Roland SP-540 Trailing Data Cable**  
Used for Roland SP-540 / Roland RS-640  
**OEM**  
**Price: ≤ \$23 / pc**



**ACC-ROL-002: Roland SJ-540 / SJ-740 Solvent Resistant Ink Pump**  
Used for Roland SJ-740 / 540, SC-540, SP-300, FP-740, FLJ-300, solvent resistant  
**OEM**  
**Price: ≤ \$28 / pc**



**ACC-ROL-003: Roland Scan Motor for FJ-540 / FJ-740**  
Used for Roland FJ-540 / 740, SJ-540 / 740 / 745EX, SC-540 / 545EX  
**OEM**  
**Price: ≤ \$192 / pc**



**ACC-ROL-004: Roland Scan Motor for SJ-1045EX**  
Used for Roland SJ-1045EX / 1000, XC-540 / 540W, XJ-640 / 740, AJ-740i / 1000i, FH-740  
**Original**  
**Price: ≤ \$767 / pc**



**ACC-ROL-005: Roland Feed Motor for FJ-540 / FJ-740**  
Used for Roland FJ-540 / 740, Roland SJ-540 / 740  
**Original**  
**Price: ≤ \$442 / pc**



**ACC-ROL-006: Roland Scan Motor for FJ-540 / FJ-740**  
Used for Roland FJ-540 / 740, SJ-540 / 740 / 745EX, SC-540 / 545EX  
**Original**  
**Price: ≤ \$485 / pc**



**ACC-ROL-007: Roland Wire for FJ-540 / FJ-545EX / SJ-540 / SJ-545EX**  
Used for Roland FJ / SJ-540 / 545EX  
**OEM**  
**Price: ≤ \$37 / pc**



**ACC-ROL-008: Roland Belt for XJ-740 / AJ-1000 / FH-740**  
Used for Roland XJ-740 / AJ-1000 / AJ-740 / FH-740 / FP-740 / SJ-1000 / SJ-1045EX  
**OEM**  
**Price: ≤ \$158 / pc**



**ACC-ROL-009: Roland Scan Motor for XC-540 / XJ-640 / 740**  
Used for Roland XC-540 / 540W, XJ-640 / 740, AJ-740i / 1000i, FH-740  
**OEM**  
**Price: ≤ \$339 / pc**



**ACC-ROL-010: Roland Wire for FJ-600**  
Used for Roland FJ-600SJ-740  
**OEM**  
**Price: ≤ \$30 / pc**



**ACC-ROL-011: Roland XJ-540 / XJ-740 Solvent Resistant Ink Pump**  
Used for Roland SJ-1045EX / 1000; XC-540 / 540W / 540MT / 640, XJ-540 / 640 / 740; RS-640 / RS-540, VP-300 / VP-540 / VP-300I / 540I; LEC-300 / LEC-300A  
**OEM**  
**Price: ≤ \$43 / pc**



**ACC-ROL-012: Roland XC-540 Wiper Rubber**  
Used for Roland XJ-640 / 740 / 1045EX / 1000, XC-540 / 540W, RS-640, VP-300I / 540I; Mimaki JV3 / JV4  
**OEM**  
**Price: ≤ \$2 / pc**



**ACC-ROL-013: Roland Feed Motor for FJ-540 / FJ-740**  
Used for Roland FJ-540 / 740, SJ-540 / 740, XC-540 / 545EX, CJ-540 / 740  
**OEM**  
**Price: ≤ \$292 / pc**



**ACC-ROL-014: Roland Circuit C4131**  
Used for Roland SJ / FJ-540 / 740  
**Original**  
**Price: ≤ \$6 / pc**



**ACC-ROL-015: Roland FJ-740 Trailing Data Cable**  
Used for Roland CJ-540, Roland FJ-500 / 540 / 600 / 740K / 740, Roland SC-540 / 545EX, Roland SJ-540 / 545EX / 640 / 645EX / 740 / 745EX  
**OEM**  
**Price: ≤ \$22 / pc**



**ACC-ROL-016: Roland Belt for XJ-640 / XJ-740 - 5.5M**  
Roland XJ-540 / XJ-640 / XC-540 / XC-540W / SC-540  
**OEM**  
**Price: ≤ \$125 / m**



**ACC-ROL-017: Roland FP-740K 8 Heads Board**  
Used for Roland FP-740K  
**OEM**  
**Price: ≤ \$534 / pc**



**ACC-ROL-018: Roland Limited Sensor**  
Used for Roland FJ-500 / 540 / 600 / 740  
**OEM**  
**Price: ≤ \$16 / pc**



**ACC-ROL-019: Roland Network Card for FJ-540 / FJ-740**  
Used for Roland FJ-540 / 740, Roland SJ-540 / 740 / 645 / 745  
**Original**  
**Price: ≤ \$868 / pc**



**ACC-ROL-020: Roland RS-640 Encoder Sensor**  
Used for Roland RS-640, SP-360 / 300 / 540, VP-300I / 540I / 540  
**OEM**  
**Price: ≤ \$35 / pc**



**ACC-ROL-021: Roland 220ml Refill Tank**  
Used for Roland SOLJET / VersaCAMM / HifiJet; Mimaki JV3 / JV4 / JV5; Mutoh Rock Hopper 2 / Falcon 2 / Falcon Plus, Mutoh RJ-8000  
**OEM**  
**Price: ≤ \$5 / pc**



**ACC-ROL-022: Roland FJ-540 / FJ-740 Original Cap Top**  
Used for Roland CJ-540, FJ-540 / 740K / 740, SC-540 / 545EX; SJ-1000 / 1045EX / 540 / 545EX / 640 / 645EX / 740 / 745EX, SP-300 / 300V / 540V; Mimaki JV3 / JV4; Mutoh RJ-8000 / 8100  
**Original**  
**Price: ≤ \$38 / pc**



**ACC-ROL-023: Roland RS-640 Print Carriage Board-W700981110**  
Used for Roland RS-640  
**Original**  
**Price: ≤ \$187 / pc**

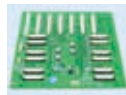

**ACC-ROL-024: Roland Carriage Board for FJ-540 / FJ-740 / SJ-540 / SJ-740**  
Used for Roland CJ-540, FJ-540 / FJ-740, SJ-540 / SJ-740 / SJ-745EX, SC-540 / SC-545EX  
**OEM**  
**Price: ≤ \$130 / pc**

## &gt; Printer Spare Parts &gt; Roland printer spare parts

**ACC-ROL-025: Roland SP-540 Print Carriage Board-W8406050F0**

Used for Roland SP-540 / SP-300 / SP-540V / SP-300V

**Original****Price: ≤ \$164 / pc****ACC-ROL-026: Roland RS-640 Main Board**

Used for Roland RS-640

**Original****Price: ≤ \$1,836 / pc****ACC-ROL-027: Roland FJ-540 / FJ-740 6 Heads Board**

Used for Roland CJ-540, FJ-540 / 740K / 740 / 600, SC-540 / 545EX; SJ-1000 / 1045EX / 540 / 545EX / 640 / 645EX / 740 / 745EX

**OEM****Price: ≤ \$584 / pc****ACC-ROL-028: Roland Servo Board for FJ-540 / FJ-740**

Used for Roland FJ-540 / 740 / 740K / 500, SJ-540 / 740 / 745EX / 1045EX / 1000, SC-540 / 545EX

**Original**

Part Number: W811904020

**Price: ≤ \$809 / pc****ACC-ROL-030: Roland Mainboard for FJ-740**

Used for Roland FJ-540 / 740K / 740, SJ-540 / 740 / 745EX

**Original**

Part Number: 7811900800

**Price: ≤ \$1,419 / pc****ACC-ROL-031: Roland Paper Guide for FJ-740 / FJ-540 / SJ-740 / SJ-540**

Used For Roland FJ-740 / 540, SJ-740 / 540

**OEM****Price: ≤ \$6 / set (2pcs / set)****ACC-ROL-032: Roland Large Gear**

Used for Roland FJ-500 / 600 / 540 / 740, Roland SJ-645 / 745EX

**Original****Price: ≤ \$32 / pc****ACC-ROL-033: Roland FJ-540 / FJ-740 L-bearing SSR15XW2UE+2740LY**

Used for Roland SJ-540 / 740 / 640 / 645, FJ-540 / 740, SJ-745EX; Mimaki JV3 / JV4

**OEM****Price: ≤ \$75 / pc****ACC-ROL-034: Roland Pulley for FJ-540 / FJ-740 / SJ-540 / SJ-740**

Used for Roland FJ-540 / 740, Roland SJ-540 / 740

**OEM****Price: ≤ \$16 / pc****ACC-ROL-035: Roland Pulley for FJ-600 / SJ-600**

Used for Roland FJ / SJ-600

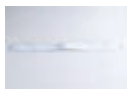
**OEM****Price: ≤ \$9 / pc****ACC-ROL-036: Roland FJ-50 DX2 Head Data Cable**

Used for Roland FJ-50 / 52, Roland CJ-500; Mimaki JV2; Mutoh RJ-6000

**OEM****Price: ≤ \$4 / pc****ACC-ROL-038: Roland Encoder Strip for FJ-540 / FJ-740**

Used for Roland FJ-500 / 600 / 540 / 740

**OEM****Price: ≤ \$17 / pc****ACC-ROL-039: Roland Encoder Sensor for FJ-540 / FJ-740 / SJ-540 / SJ-740**

Used for Roland FJ-500 / 540 / 600 / 740K / 740, Roland SJ-540 / 545EX / 640 / 645EX / 740 / 745EX

**OEM****Price: ≤ \$19 / pc****ACC-ROL-040: Roland DX4 Head Data Cable for FJ-540 / FJ-740 / SJ-540 / SJ-740**

Used for Roland SJ-540 / 740, Roland FJ-540 / 740

**OEM****Price: ≤ \$3 / pc****ACC-ROL-042: Roland Sponge**

Used for Roland FJ-540 / 740, SJ-540 / 740, Mimaki JV3 / JV4, Mutoh RJ-8000 / 8100

**OEM****Price: ≤ \$3 / pc****ACC-ROL-043: Cleaning Swab**

Used for all Roland, Mimaki, Mutoh printers

**OEM****Price: ≤ \$18 / package (100pcs / package)****ACC-ROL-044: Epson DX3 / DX4 / DX5 Printhead Small Damper**

Used for Epson DX3 / DX4 / DX5 Head, R1800 / 1900 / 1390 / 2400 / 1100; Roland FJ-540 / 740 / 600, SJ-540 / 740; SP-300 / 540, SC-540 / 545; Mimaki JV3 / JV4 / JV22; Mutoh VJ-1204 / 1304, RJ-8000 / 8100 / 900C; Mutoh Rock Hopper I / II, Mutoh FalconII, Mutoh Falcon Plus

**OEM****Price: ≤ \$3 / pc****ACC-ROL-045: Roland FJ-540 / FJ-740 Water Based Ink Pump**

Used for Roland FJ-740 / 540, Epson 7000, water based

**OEM****Price: ≤ \$15 / pc****ACC-ROL-046: All-glass Syringe**

Used for all Roland, Mimaki, Mutoh printers

**OEM****Price: ≤ \$5 / pc****ACC-ROL-047: ECO Solvent Ink Pump Tube**

Used for Roland FJ-500 / 540 / 600 / 740, XJ-740 / 640, SP-300 / 540, SC-540, SJ-540 / 740; Mimaki JV2 / JV3 / JV4 / JV22 / JV33 / JV5; Mutoh RJ-6000 / 8000

**OEM****Price: ≤ \$3 / m****ACC-ROL-048: Roland FJ-500 / FJ-600 Water Based Pump Station**

Used for Roland FJ-500 / 600

**Original****Price: ≤ \$75 / pc****ACC-ROL-049: Epson DX4 Printhead Small Damper with Big Filter**

Used for Epson DX4 Head; Roland FJ-740 / 540; Mimaki JV3; Mutoh Rock Hopper I / II, Mutoh FalconII, Falcon Plus

**OEM****Price: ≤ \$3 / pc****ACC-ROL-050: ECO Solvent Ink Tube**

Used for Roland FJ-500 / 540 / 600 / 740, XJ-740 / 640, SP-300 / 540, SC-540, SJ-540 / 740; Mimaki JV2 / JV3 / JV4 / JV22 / JV33 / JV5; Mutoh RJ-6000 / 8000

**OEM****Price: ≤ \$3 / m**

## &gt; Printer Spare Parts &gt; Roland printer spare parts



**ACC-ROL-051: Roland Encoder Sensor for XJ-640 / XJ-740**  
Used for Roland XC-540 / 540W, Roland XJ-640 / 740  
**OEM**  
**Price: ≤ \$23 / pc**



**ACC-ROL-052: Roland FJ / SJ-540 / 740 Cleaning Motor**  
Used for Roland FJ-540 / 740, Roland SJ-540 / 740  
**OEM**  
**Price: ≤ \$40 / pc**



**ACC-ROL-053: Roland Circuit A1746**  
Used for Roland SJ / FJ-540 / 740  
**Original**  
**Price: ≤ \$6 / pc**



**ACC-ROL-054: DX4 Solvent Printhead Manifold / Adapter**  
Used for Roland SOLJET / VersaCAMM / HifiJet; Mimaki JV3 / JV4 / JV2II; Mutoh Rock Hopper I / II, Mutoh FalconII; Solvent resistant  
**OEM**  
**Price: ≤ \$7 / pc**



**ACC-ROL-055: Roland FJ-500 / FJ-600 Water Based Ink Pump**  
Used for Roland FJ-500 / 600  
**Original**  
**Price: ≤ \$83 / pc**



**ACC-ROL-056: Roland Cap Top for SJ-740 / VP-540**  
Used for Roland SJ-740 / VP-540, Mutoh Rock Hopper I / II, Mutoh FalconII / Spitfire  
**OEM**  
**Price: ≤ \$22 / pc**



**ACC-ROL-058: Roland Wire for FJ-740 / SJ-740**  
Used for Roland FJ / SJ-740  
**OEM**  
**Price: ≤ \$37 / pc**



**ACC-ROL-059: Roland SP-540 Main Board**  
Used for Roland SP-540  
**Original**  
**Price: ≤ \$1,849 / pc**



**ACC-ROL-060: Roland Feed Motor for SP-300 / SP-540V**  
Used for Roland SP-300 / 540V  
**Original**  
**Price: ≤ \$392 / pc**



**ACC-ROL-063: Roland VS-640 Encoder Sensor**  
Used for Roland VS-640  
**OEM**  
**Price: ≤ \$41 / pc**



**ACC-ROL-064: Roland RS-640 Feed Motor Board**  
Used for Roland RS-640 / RS-540  
**Original**  
**Price: ≤ \$175 / pc**



**ACC-ROL-065: Roland Scan Motor for SP-540V / SP-300**  
Used for Roland SP-540V / 300  
**Original**  
**Price: ≤ \$442 / pc**



**ACC-ROL-066: Roland Scan Motor for VP-540 / VP-300 / RS-640**  
Used for Roland VP-540 / VP-300 / RS-640  
**Original**  
**Price: ≤ \$383 / pc**



**ACC-ROL-068: Roland SJ-1045 Carriage Board - W853905380**  
Used for Roland SJ-1000 / SJ-1045EX  
**Original**  
**Price: ≤ \$209 / pc**



**ACC-ROL-071: Roland SP540V Servo Board - 7840605600**  
Used for Roland SP-540V  
**Original**  
**Price: ≤ \$761 / pc**



**ACC-ROL-072: Roland SP540V Power Board - 12429114**  
Used for Roland SP-540V  
**Original**  
**Price: ≤ \$574 / pc**



**ACC-ROL-073: Roland FJ / SJ / XJ - 740 / 540 / 640 Photo Sensor**  
Used for Roland FJ / SJ / XJ - 740 / 540 / 640  
**OEM**  
**Price: ≤ \$15 / pc**



**ACC-ROL-075: Roland ECO Solvent Ink Tube 3mm x 4mm**  
Used for Roland, Mimaki, Mutoh printers  
**OEM**  
**Price: ≤ \$3 / pc**



**ACC-ROL-076: Roland Belt for RS / VP / VS / SP**  
Used for Roland RS-640 / VP-300 / VP-540 / VS-540 / VS-640 / SP-300 / SP-540  
**OEM**  
**Price: ≤ \$97 / pc**



**ACC-ROL-077: Roland FJ-740 Panel Cable 24pin, 100cm**  
Used for Roland FJ-740 / 540, SJ-740 / 540  
**OEM**  
**Price: ≤ \$5 / pc**



**ACC-ROL-078: Roland XC / XJ-540 Fuse-3.15A 72V**  
Used for Roland XC / XJ-540  
**Original**  
**Price: ≤ \$2 / pc**



**ACC-ROL-079: Roland XC-540 / XJ-640 Trailing Data Cable - 36pin, 3490mm**  
Used for Roland XC-540 / XJ-640  
**OEM**  
**Price: ≤ \$15 / pc**



**ACC-ROL-080: Roland VP-540 Mainboard - 6700469010**  
Used for VP-540  
**Original**  
**Price: ≤ \$2,104 / pc**



**ACC-ROL-081: Copper Screw with O - ring for Small Damper Ink Piping**  
Used for Epson DX3 / DX4 / DX5 Head, R1800 / 1900 / 2400; Roland FJ-540 / 740 / 600, SJ-540 / 740, SP-300 / 540, SC-540 / 545ex; Mimaki JV3 / JV4 / JV22; Mutoh VJ-1204 / 1304, RJ-8000 / 8100 / 900C, Mutoh Rock Hopper I / II, Mutoh FalconII, Mutoh Falcon Plus  
**OEM**  
**Price: ≤ \$1 / pc**



**ACC-ROL-082: Copper Screw with O - ring for Big Damper Ink Piping**  
Used for Epson DX4 / DX5 head; Roland VP-300 / VP-540 / XC-540 / XJ-640 / XJ-740 / RS-640, SJ-640 / 1000 / 1045, FP-740; Mimaki JV3 / JV4 / JV22; Mutoh VJ-1604 / 1604W / RJ-900  
**OEM**  
**Price: ≤ \$1 / pc**



**ACC-ROL-083: Roland AJ-1000 Chip**  
Used for Roland AJ-1000  
**OEM**  
**Price: ≤ \$8 / pc**

## &gt; Printer Spare Parts &gt; Roland printer spare parts

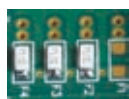

**ACC-ROL-084: Roland FJ / FP-740 Fuse - 3.15A 63V**  
Used for Roland FJ / FP - 740 Fuse  
**Original**  
**Price: ≤ \$2 / pc**



**ACC-ROL-085: Roland FJ-740K Photo Interrupter**  
Used for Roland FJ-740K  
**OEM**  
**Price: ≤ \$15 / pc**



**ACC-ROL-087: Ink Tube UV 2mm x 3mm**  
Used for Roland Mimaki, Mutoh Printers  
**OEM**  
**Price: ≤ \$3 / pc**



**ACC-ROL-088: New Cleaning Swab**  
Used for Roland, Mimaki, Mutoh Printers  
**OEM**  
**Price: ≤ \$23 / pc**



**ACC-ROL-089: 21565102 P-Roller TD16S4 (B10) Typr2**  
Used for Roland CJ-540  
**Original**  
**Price: ≤ \$43 / pc**



**ACC-ROL-090: Roland FJ-740 Power Board**  
Used for Roland FJ-740  
**Original**  
**Price: ≤ \$885 / pc**



**ACC-ROL-091: Roland SP300i ECO Solvent Chips**  
Used for Roland SP300i  
**OEM**  
**Price: ≤ \$30 / pc**



**ACC-ROL-092: Roland FJ-540 / 740 Panel Board**  
Used for Roland FJ-540 / 740  
**Original**  
**Price: ≤ \$262 / pc**



**ACC-ROL-093: Roland XJ / XC-640 Head Board for 6 Heads**  
Used for Roland XJ / XC 540 / 640 / 740  
**OEM**  
**Price: ≤ \$34 / pc**



**ACC-ROL-094: Cleaning Swab**  
Used for all serials  
**OEM**  
**Price: ≤ \$6 / parcel (50pcs / parcel)**



**ACC-ROL-095: Big Cleaning Swab**  
Used for all serials  
**OEM**  
**Price: ≤ \$13 / parcel (50pcs / parcel)**



**ACC-ROL-099: Roland XC-540 ECO Solvent Chips**  
Used for Roland XC-540, Roland VP-300 / 540, Roland XJ-640 / 740, Roland RS-640 / 540  
**OEM**  
**Price: ≤ \$41 / set (6pcs / set)**



**ACC-ROL-102: Roland VP540 Print Carriage Board**  
Used for Roland VP-540  
**Original**  
**Price: ≤ \$259 / pc**



**ACC-ROL-103: Roland Encoder Strip for AJ-1000 - 3.6M**  
Used for Roland AJ-1000 / SJ-1000  
**OEM**  
**Price: ≤ \$26 / pc**



**ACC-ROL-104: Roland Scan Motor for VP-540**  
Used for Roland VP-540 / VP-300 / RS-640  
**OEM**  
**Price: ≤ \$230 / pc**



**ACC-ROL-105: Roland FJ-740 Wiper Belt**  
Used for Roland FJ-740  
**OEM**  
**Price: ≤ \$16 / pc**



**ACC-ROL-106: Roland FP-740 Carriage Board**  
Used for Roland FP-740  
**Original**  
**Price: ≤ \$492 / pc**



**ACC-ROL-107: Roland Network Card for SP-540**  
Used for Roland SP-540  
**Original**  
**Price: ≤ \$852 / pc**



**ACC-ROL-108: Roland XJ-740 mainboard**  
Used for Roland XJ-740  
**Original**  
**Price: ≤ \$1.770 / pc**



**ACC-ROL-109: Roland IC - Linear, MTD2005-7101 Pump Motor Driver - 15189105**  
Used for Roland AJ / CJ / FJ / FP / SC / SJ / SP  
**Original**  
**Price: ≤ \$10 / pc**



**ACC-ROL-110: IC - Linear, MTD2005F-3072 Wipe Motor Driver - 15189111**  
Used for Roland AJ / CJ / FJ / FP / SC / SJ / SP  
**Original**  
**Price: ≤ \$9 / pc**



**ACC-ROL-111: TR, MOS UPA1759G-E2-A Fan Driver - 15119119**  
Used for Roland AJ / CJ / FJ / FP / SC / SJ / SP  
**Original**  
**Price: ≤ \$4 / pc**



**ACC-ROL-112: V. RGL L4960 5V Regulator - 15199237**  
Used for Roland AJ / CJ / FJ / FP / SC / SJ / SP  
**Original**  
**Price: ≤ \$6 / pc**



**ACC-ROL-113: IC, E09A54RA D / A Converter for Head - 1000001098**  
Used for Roland AJ / CJ / FJ / FP / SC / SJ / SP  
**Original**  
**Price: ≤ \$6 / pc**



**ACC-ROL-114: Roland VP-300 / 540 F 154 Fuse002. DR for 41V - 1000003014**  
Used for Roland VP-300 / 540  
**Original**  
**Price: ≤ \$2 / pc**



**ACC-ROL-115: Roland FJ-540 Cable Card 25P1 105L BB**  
Used for Roland AJ-1000 / 740, CJ-540, FJ-540, SC-540 / 545EX, SJ-540 / 640 / 645EX / 740 / SJ-745EX, SP-300 / 300V / 540V, VP-300 / 540  
**OEM**  
**Price: ≤ \$5 / pc**



**ACC-ROL-117: Roland XC-540 Wiper Rubber**  
Used for Roland XJ-640 / 740 / 1045EX / 1000, Roland XC-540 / 540W, Roland RS-640, Roland VP-300 / 540, Mimaki JV3 / JV4  
**OEM**  
**Price: ≤ \$2 / pc**



## &gt; Printer Spare Parts &gt; Roland printer spare parts



**ACC-ROL-119: Roland SP-300 Cable - card 24P1 600L BB**  
Used for Roland RS-540 / 640, SP-300 / 300I / 300V / 540I / 540V,  
VP-300 / 300I / 540 / 540I, VS-300 / 420 / 540 / 640

**OEM**

**Price: ≤ 7 / pc**



**ACC-ROL-120: Roland DX7 FH-740 / RA-640 Damper**  
Used for Roland FH-740 / RA-640, RE-640 / VS-640 / VS-540 /  
VS-420 / VS-300

**Original**

**Price: ≤ 30/ pc**



**ACC-ROL-121: Roland FJ-540 / FJ-740 / SJ-540 / SJ-740**  
**Sponge**

Used for Roland, Mimaki, Muoth printers

**OEM**

**Price: ≤ 3 / pc**



**ACC-ROL-122: Roland Scan Motor for SP-300 / 540**

Used for Roland SP-300 / 540

**OEM**

**Price: ≤ 197 / pc**



**ACC-ROL-123: Roland VS-640 Refill Tank 440ml**

Used for Roland VS-640

**OEM**

**Price: ≤ 7 / pc**



**ACC-ROL-124: Roland XJ-640 Mainboard**

Used for Roland XJ-640

**Original**

**Price: ≤ 1,902 / pc**



**ACC-ROL-126: Roland FH-740 Mainboard**

Used for Roland FH-740

**Original**

**Price: ≤ 1,902 / pc**



**ACC-ROL-127: Epson DX3 / DX4 / DX5 Printhead Small**  
**Damper**

Used for Epson DX3 / DX4 / DX5 Head, R1800 / 1900 / 2400  
Roland FJ-540 / 740 / 600, SJ-540 / 740, SP-300 / 540, SC-540 /  
545ex

Mimaki JV3 / JV4 / JV22

Mutoh VJ-1204 / 1304, RJ-8000 / 8100 / 900C, Mutoh Rock  
Hopper I / II, Mutoh FalconII, Mutoh Falcon Plus

**OEM**

**Price: ≤ 3 / pc**

## &gt; Printer Spare Parts &gt; Mimaki printer spare parts



**ACC-MIM-001: Mimaki JV3 Big Damper with Resize Adapter**  
Used for Epson DX3 / DX4 head, Roland FJ-740 / 540 / VP-540 / XC-540 / XJ-640 / RS-640, SJ-740 / 540 / 640 / 1000 / 1045ex; Mimaki JV3 / JV4 / JV22; Mutoh VJ-1204 / 1304 / 1604 / 1604W / RJ-900C

**OEM**  
**Price: ≤ \$5 / pc**



**ACC-MIM-002: Mimaki JV5 Damper**  
Used for Epson DX5 Head, Mimaki JV5 / JV33

**OEM**  
**Price: ≤ \$4 / pc**



**ACC-MIM-003: Mimaki Service Station for JV3**  
Used for Mimaki JV3

**Original**  
**Price: ≤ \$409 / pc**



**ACC-MIM-004: Mimaki 1394 Mainboard**  
Used for Mimaki JV3 / JV4 / JV22

**OEM**  
**Price: ≤ \$325 / pc**



**ACC-MIM-005: Mimaki 1394 Transfer Card**  
Used for Mimaki JV3 / JV4 / JV22

**OEM**  
**Price: ≤ \$47 / pc**



**ACC-MIM-006: Mimaki JV3 / JV33 / JV5 Solvent Resistant Ink Pump**  
Used for Mimaki JV3 / JV33 / JV5

**OEM**  
**Price: ≤ \$36 / pc**



**ACC-MIM-007: Mimaki JV33 Slider Board**  
Used for Mimaki JV33

**Original**  
**Price: ≤ \$434 / pc**



**ACC-MIM-008: Mimaki Scan Motor for JV22 / JV3**  
Used for Mimaki JV22 / JV3

**Original**  
**Price: ≤ \$701 / pc**



**ACC-MIM-009: Mimaki Scan Motor for JV4**  
Used for Mimaki JV4

**Original**  
**Price: ≤ \$884 / pc**



**ACC-MIM-010: Mimaki Cap Top for JV33 / JV5**  
Used for Mimaki JV33, Mimaki JV5

**OEM**  
**Price: ≤ \$18 / pc**



**ACC-MIM-011: Mimaki Encoder Sensor for JV3 / JV22**  
Used for Mimaki JV3 / JV22

**OEM**  
**Price: ≤ \$50 / pc**



**ACC-MIM-012: Mimaki Encoder Sensor for JV4**  
Used for Mimaki JV4

**OEM**  
**Price: ≤ \$63 / pc**



**ACC-MIM-013: Mimaki JV33 / JV5 Damper Connector**  
Used for Mimaki JV33 / JV5

**OEM**  
**Price: ≤ \$3 / pc**



**ACC-MIM-014: Mimaki Scan Motor for JV5**  
Used for Mimaki JV5

**Original**  
**Price: ≤ \$1,135 / pc**



**ACC-MIM-015: Mimaki JV3 I / O Board (second-hand)**  
Used for Mimaki JV22 / JV3

**Original**  
**Price: ≤ \$383 / pc**



**ACC-MIM-016: Mimaki Scan Motor for JV5**  
Used for Mimaki JV5

**OEM**  
**Price: ≤ \$434 / pc**



**ACC-MIM-017: Mimaki Scan Motor for JV33**  
Used for Mimaki JV33

**OEM**  
**Price: ≤ \$383 / pc**



**ACC-MIM-018: Mimaki X - axis Motor for JV33**  
Used for Mimaki JV33

**Original**  
**Price: ≤ \$667 / pc**



**ACC-MIM-019: Mimaki JV4 Mainboard (second - hand)**  
Used for Mimaki JV4

**Original**  
**Price: ≤ \$1,502 / pc**



**ACC-MIM-020: Mimaki JV4 HDC Board (second - hand)**  
Used for Mimaki JV4

**Original**  
**Price: ≤ \$534 / pc**



**ACC-MIM-021: Mimaki JV4 Slider Board**  
Used for Mimaki JV4

**OEM**  
**Price: ≤ \$284 / pc**



**ACC-MIM-022: Mimaki JV4 I / O Board**  
Used for Mimaki JV4

**OEM**  
**Price: ≤ \$317 / pc**

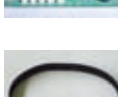

**ACC-MIM-023: Mimaki CR Belt**  
Used for Mimaki JV33 / JV5 / JV22 / JV3 / JV4

**Original**  
**Price: ≤ \$23 / pc**



**ACC-MIM-024: Mimaki Double - decked Pulley**  
Used for Mimaki JV33 / JV5 / JV22 / JV3 / JV4

**OEM**  
**Price: ≤ \$63 / pc**



**ACC-MIM-025: Mimaki Pulley**  
Used for Mimaki JV33 / JV5 / JV22 / JV3 / JV4

**OEM**  
**Price: ≤ \$47 / pc**



**ACC-MIM-026: Mimaki Cap Sensor**  
Used for Mimaki JV22 / JV3 / JV4 / JV5 / JV33

**OEM**  
**Price: ≤ \$18 / pc**



**ACC-MIM-027: Mimaki JV33 / JV5 Paper Width Sensor**  
Used for JV33 / JV5

**OEM**  
**Price: ≤ \$16 / pc**



**ACC-MIM-028: Mimaki JV3 Mainboard (second - hand)**  
Used for Mimaki JV3

**Original**  
**Price: ≤ \$2,086 / pc**

## &gt; Printer Spare Parts &gt; Mimaki printer spare parts



**ACC-MIM-029: Mimaki JV4 / JV2II Water Based Ink Pump**  
Used for Mimaki JV4 / JV2II, water based  
**OEM**  
**Price: ≤ \$20 / pc**



**ACC-MIM-030: Mimaki Wiper Holder for JV33**  
Used for Mimaki JV33  
**OEM**  
**Price: ≤ \$4 / pc**



**ACC-MIM-031: Mimaki Wiper Holder for JV3 / JV4**  
Used for Mimaki JV3 / JV4  
**OEM**  
**Price: ≤ \$3 / pc**



**ACC-MIM-032: Mimaki JV33 / JV5 Big Wiper**  
Used for Mimaki JV33 / JV5  
**OEM**  
**Price: ≤ \$3 / pc**



**ACC-MIM-033: Mimaki Encoder Sensor for JV33 / JV5**  
Used for Mimaki JV33 / JV5  
**OEM**  
**Price: ≤ \$41 / pc**



**ACC-MIM-034: Mimaki Scan Motor for JV22 / JV3**  
Used for Mimaki JV3 / JV22  
**OEM**  
**Price: ≤ \$317 / pc**



**ACC-MIM-035: Mimaki Scan Motor for JV4**  
Used for Mimaki JV4  
**OEM**  
**Price: ≤ \$284 / pc**



**ACC-MIM-036: Mimaki JV4 Power Board**  
Used for Mimaki JV4  
**Original**  
**Price: ≤ \$300 / pc**



**ACC-MIM-037: Mimaki Scan Motor for JV33**  
Used for Mimaki JV33  
**Original**  
**Price: ≤ \$826 / pc**



**ACC-MIM-038: Mimaki Cap Top for JV3**  
Used for Mimaki JV3  
**OEM**  
**Price: ≤ \$16 / pc**



**ACC-MIM-039: Mimaki Cap Top for JV4**  
Used for Mimaki JV4  
**OEM**  
**Price: ≤ \$19 / pc**



**ACC-MIM-040: 440ml Refill Tank**  
Used for Roland soljet / Versa CAMM / HifiJet / VP-540 / XJ-640 / XC-540; Mimaki JV3 / JV4 / JV22 / JV33 / JV5; Mutoh Rock Hopper 2 / Falcon 2 / Falcon plus, Mutoh RJ-8000  
**OEM**  
**Price: ≤ \$9 / pc**



**ACC-MIM-041: Mimaki Encoder Strip for JV3**  
Used for Mimaki JV3 / JV4  
**OEM**  
**Price: ≤ \$21 / pc**



**ACC-MIM-042: Mimaki JV33 Mainboard**  
Used for Mimaki JV33  
**Original**  
**Price: ≤ \$1,752 / pc**



**ACC-MIM-043: Mimaki JV3 DX4 Head Data Cable**  
Used for Mimaki JV3  
**OEM**  
**Price: ≤ \$3 / pc**



**ACC-MIM-044: Mimaki JV33 / JV5 DX5 Head Data Cable**  
Used for Mimaki JV33 / JV5  
**OEM**  
**Price: ≤ \$3 / set**



**ACC-MIM-045: Mimaki JV5 Long Data Cable**  
Used for Mimaki JV5  
**OEM**  
**Price: ≤ \$37 / pc**



**ACC-MIM-046: Mimaki JV4 Long Data Cable**  
Used for Mimaki JV4  
**OEM**  
**Price: ≤ \$25 / pc**



**ACC-MIM-047: Mimaki JV33 Long Data Cable**  
Used for Mimaki JV33  
**OEM**  
**Price: ≤ \$67 / pc**



**ACC-MIM-049: Mimaki JV22 / JV3 / JV4 Paper Width Sensor**  
Used for Mimaki JV22 / JV3 / JV4  
**OEM**  
**Price: ≤ \$18 / pc**



**ACC-MIM-052: Mimaki JV22 / JV3 / JV4 Limited Sensor**  
Used for Mimaki JV22 / JV3 / JV4  
**OEM**  
**Price: ≤ \$16 / pc**



**ACC-MIM-053: Mimaki JV33 / JV5 Limited Sensor**  
Used for Mimaki JV33 / JV5  
**OEM**  
**Price: ≤ \$16 / pc**



**ACC-MIM-055: Mimaki JV33 / JV5 Wiper Sensor**  
Used for Mimaki JV33 / JV5  
**OEM**  
**Price: ≤ \$16 / pc**



**ACC-MIM-056: Mimaki JV5 Carriage Up and Down Sensor**  
Used for Mimaki JV5  
**OEM**  
**Price: ≤ \$33 / pc**



**ACC-MIM-057: Mimaki JV5 Paper Width Sensor**  
Used for JV5  
**OEM**  
**Price: ≤ \$28 / pc**



**ACC-MIM-059: Mimaki JV5 Head Board + Fuse**  
Used for JV5  
**OEM**  
**Price: ≤ \$74 / pc**



**ACC-MIM-060: Mimaki Encoder Strip for JV5-320 / JV5-260 - 5m**  
Used for JV5  
**OEM**  
**Price: ≤ \$28 / pc**



**ACC-MIM-063: Mimaki JV4 HDC Board Cable, 40pin, 40cm**  
Used for JV4  
**OEM**  
**Price: ≤ \$5 / pc**

## &gt; Printer Spare Parts &gt; Mimaki printer spare parts



**ACC-MIM-064: Mimaki JV4 Head Cable, 21pin, 35cm**  
Used for JV4  
OEM  
**Price: ≤ \$3 / pc**



**ACC-MIM-065: Mimaki JV4 Long Cable, 30pin**  
Used for JV4  
OEM  
**Price: ≤ \$24 / pc**



**ACC-MIM-066: Mimaki JV4 Belt, 5.5M**  
Used for JV4  
OEM  
**Price: ≤ \$78 / pc**



**ACC-MIM-067: Mimaki JV5 Belt - 6.5M**  
Used for JV5  
OEM  
**Price: ≤ \$87 / pc**



**ACC-MIM-068: Mimaki JV33 / JV5 Capping Unit Original**  
Used for Mimaki JV33 / JV5  
Original  
**Price: ≤ \$57 / pc**



**ACC-MIM-069: Mimaki JV5 / JV33 Damper UV**  
Used for Mimaki JV33 / JV5  
OEM  
**Price: ≤ \$5 / pc**



**ACC-MIM-070: Mimaki JV33 / JV5 Damper Connector UV**  
Used for Mimaki JV33 / JV5  
OEM  
**Price: ≤ \$3 / pc**



**ACC-MIM-071: Mimaki JV3 SS1 Chip**  
Used for Mimaki JV3  
OEM  
**Price: ≤ \$23 / pc**



**ACC-MIM-072: Mimaki JV3 ES3 Chip**  
Used for Mimaki JV3  
OEM  
**Price: ≤ \$16 / pc**



**ACC-MIM-073: Mimaki JV3 SS2 Chip**  
Used for Mimaki JV3  
OEM  
**Price: ≤ \$23 / pc**



**ACC-MIM-074: Mimaki JV33 SS21 Chip**  
Used for Mimaki JV33  
OEM  
**Price: ≤ \$16 / pc**



**ACC-MIM-075: Mimaki JV33 SB51 Chip**  
Used for Mimaki JV33  
OEM  
**Price: ≤ \$16 / pc**



**ACC-MIM-076: Mimaki JV33 SB52 Chip**  
Used for Mimaki JV33  
OEM  
**Price: ≤ \$16 / pc**



**ACC-MIM-077: Mimaki JV5 HS Chip**  
Used for Mimaki JV5  
OEM  
**Price: ≤ \$23 / pc**



**ACC-MIM-078: Mimaki JV5 PIG Chip**  
Used for Mimaki JV5  
OEM  
**Price: ≤ \$16 / pc**



**ACC-MIM-079: Mimaki JV5 SB51 Chip**  
Used for Mimaki JV5  
OEM  
**Price: ≤ \$16 / pc**



**ACC-MIM-080: Mimaki JV5 SB52 Chip**  
Used for Mimaki JV5  
OEM  
**Price: ≤ \$16 / pc**



**ACC-MIM-081: Mimaki JV33 Media Clamp**  
Used for Mimaki JV33  
OEM  
**Price: ≤ \$13 / pc**



**ACC-MIM-082: Mimaki JV33 Fan Original**  
Used for Mimaki JV33  
OEM  
**Price: ≤ \$87 / pc**



**ACC-MIM-083: Mimaki JV4 Head Cable, 21pin, 50cm**  
Used for Mimaki JV4  
OEM  
**Price: ≤ \$2 / pc**



**ACC-MIM-085: Mimaki JV34 Damper**  
Used for Mimaki JV34 / TS34  
Original  
**Price: ≤ \$21 / pc**



**ACC-MIM-086: Mimaki X - Axis Motor for JV4**  
Used for Mimaki JV4  
Original  
**Price: ≤ \$485 / pc**



**ACC-MIM-087: Generic Mimaki JV33 Power Board**  
Used for Mimaki JV33  
OEM  
**Price: ≤ \$283 / pc**



**ACC-MIM-090: Mimaki JV33 SS21 Chip**  
Used for Mimaki JV33  
OEM  
**Price: ≤ \$16 / pc**

## &gt; Printer Spare Parts &gt; Mutoh printer spare parts



**ACC-WT-001: Mutoh 50" Steel Belt**  
Used for Mutoh RJ-8000 / 8100, Mutoh RH2, Mutoh VJ-1604 / 1604W  
**OEM**  
**Price: ≤ \$40 / pc**



**ACC-WT-002: Mutoh VJ-1204 / VJ-1604 Capping Unit**  
Used for Mutoh VJ-1204 / 1604E / VJ-1304 / VJ-1304W / VJ-1604W / VJ-1614 / VJ-1608H  
**OEM**  
**Price: ≤ \$20 / pc**



**ACC-WT-003: Mutoh RJ-8000 Long Data Cable**  
Used for Mutoh RJ-8000  
**OEM**  
**Price: ≤ \$22 / pc**



**ACC-WT-004: Mutoh RH2 Solvent Resistant Ink Pump**  
Used for Mutoh RH2 / FalconII / Spitfire, solvent resistant  
**OEM**  
**Price: ≤ \$28 / pc**



**ACC-WT-005: Mutoh Carriage Card (Second - hand)**  
Used for Mutoh RJ-8000 / 8100 / Rock Hopper2  
**Original**  
**Price: ≤ \$200 / pc**



**ACC-WT-006: Mutoh Servo Motor for VJ-1604**  
Used for Mutoh VJ-1604 / 1204 / 1618  
**OEM**  
**Price: ≤ \$225 / pc**



**ACC-WT-007: Mutoh RJ-8000 Mainboard for 4 Heads (Second-hand)**  
Used for Mutoh RJ-8000 Mainboard for 4 Heads  
**Original**  
**Price: ≤ \$1,051 / pc**



**ACC-WT-008: Epson Stylus Pro 7880 / 9880 Pump Capping Assembly**  
Used for Mutoh VJ-1604W / 900C, Epson Stylus Pro7400 / 7450 / 7880 / 9880 / 9450 / 9400  
**Original**  
**Price: ≤ \$134 / pc**



**ACC-WT-009: Mutoh RJ-8000 CR Speed Reduction Belt**  
Used for Mutoh RJ-8000 / RJ-8100 / RH2  
**Original**  
**Price: ≤ \$27 / pc**



**ACC-WT-010: Mutoh VJ-1618 Damper**  
Used for Mutoh VJ-1614 / 1618K / 1618W / 1608, Epson Stylus Pro 7700 / 9700 / 7900 / 7910 / 9910 / 9900 / 11880C  
**OEM**  
**Price: ≤ \$7 / pc**



**ACC-WT-011: Mutoh VJ-1204 / VJ-1604 / VJ-1304 CR Board**  
Used for Mutoh VJ-1204 / 1304 / 1604 / 1604W  
**Original**  
**Price: ≤ \$209 / pc**



**ACC-WT-012: Mutoh VJ-1204 / VJ-1604 / VJ-1304 Mainboard**  
Used for Mutoh VJ-1204 / 1304 / 1604 / 1604W  
**Original**  
**Price: ≤ \$2,504 / pc**



**ACC-WT-013: Mutoh VJ-1204 / VJ-1604 / VJ-1304 Panel Unit**  
Used for Mutoh VJ-1204 / 1304 / 1604 / 1604W / 1618K / 1618W / 2606E  
**Original**  
**Price: ≤ \$333 / pc**



**ACC-WT-014: Mutoh VJ-1204 / VJ-1604 / VJ-1304 Power Board**  
Used for Mutoh VJ-1204 / 1304 / 1604 / 1604W  
**Original**  
**Price: ≤ \$450 / pc**



**ACC-WT-015: Mutoh ValueJet VJ-1604 DIMM Memory of 128M**  
Used for Mutoh VJ-1204 / 1304 / 1604 / 1604W  
**OEM**  
**Price: ≤ \$33 / pc**



**ACC-WT-016: Mutoh VJ-1604 CR Speed Reduction Belt**  
Used for Mutoh VJ-1604 / VJ-1604W / VJ-1614 / VJ-1608H / 1618K / 1618W / 2606E  
**Original**  
**Price: ≤ \$30 / pc**



**ACC-WT-017: Mutoh VJ-1204 Head Data Cable**  
Used for Mutoh VJ-1204 / 1304 / 900C  
**OEM**  
**Price: ≤ \$3 / pc**



**ACC-WT-018: Mutoh Panel Cable for VJ-1204**  
Used for Mutoh VJ-1204 / 1304  
**OEM**  
**Price: ≤ \$8 / pc**



**ACC-WT-019: Mutoh CR Motor for VJ-1204**  
Used for Mutoh VJ-1204 / VJ-1304 / RJ-900C / RJ-901C  
**Original**  
**Price: ≤ \$417 / pc**



**ACC-WT-020: Mutoh PF Motor for VJ-1204**  
Used for Mutoh VJ-1204 / 1304 / 1604 / 1604W / 1618K / 1618W / 2606E / VJ-1614 / RJ-900C / RJ-901C / VJ-1608H  
**Original**  
**Price: ≤ \$325 / pc**



**ACC-WT-021: Mutoh CR Encoder Sensor for VJ-1204**  
Used for Mutoh VJ-1204 / 1304 / 1604 / 1604W / 1614 / 1608H / 2606E / RJ-900C  
**OEM**  
**Price: ≤ \$33 / pc**



**ACC-WT-022: Mutoh VJ-1604 Solvent Resistant Pump Capping Assembly**  
Used for Mutoh VJ-1614 / 1204 / 1304 / 1604E  
**OEM**  
**Price: ≤ \$292 / pc**



**ACC-WT-023: Mutoh Absorbent Sponge for VJ-1604**  
Used for Mutoh VJ-1604, Mutoh VJ-1604W  
**Original**  
**Price: ≤ \$20 / pc**



**ACC-WT-024: Mutoh RJ-8000 CR Speed Reduction Belt**  
Used for Mutoh RJ-8000 / RJ-8100 / RH2  
**OEM**  
**Price: ≤ \$16 / pc**

## &gt; Printer Spare Parts &gt; Mutoh printer spare parts



**ACC-WT-025: Mutoh RJ-8000 Water Based Ink Pump**  
Used for Mutoh RJ-8000, water based  
**OEM**  
**Price: ≤ \$15 / pc**



**ACC-WT-026: Mutoh Servo Motor for VJ-1604**  
Used for Mutoh VJ-1604 / 1204 / 1618,RJ-8000  
**OEM**  
**Price: ≤ \$184 / pc**



**ACC-WT-027: Mutoh 87" Steel Belt**  
Used for Mutoh RJ-8000 / 8100  
**OEM**  
**Price: ≤ \$42 / pc**



**ACC-WT-028: Mutoh 64" Steel Belt**  
Used for Mutoh RJ-8000 / 8100  
**OEM**  
**Price: ≤ \$40 / pc**



**ACC-WT-029: Mutoh Encoder Strip for RJ-8000**  
Used for Mutoh VJ-1604, RJ-8000 / 8100  
**OEM**  
**Price: ≤ \$18 / pc**



**ACC-WT-030: Mutoh T Shape Pulley**  
Used for Mutoh VJ-1604 / 1604W / 1618K / 1618W / 2606E  
**Original**  
**Price: ≤ \$225 / pc**



**ACC-WT-031: Mutoh RJ-8000 Mainboard for 8 Heads (Second - hand)**  
Used for Mutoh RJ-8000  
**Original**  
**Price: ≤ \$1,385 / pc**



**ACC-WT-032: Mutoh VJ-1604 Long Data Cable**  
Used for Mutoh VJ-1604 / 1604W  
**OEM**  
**Price: ≤ \$23 / pc**



**ACC-WT-033: Mutoh RJ-8000 DX4 Head Data Cable**  
Used for Mutoh RJ-8000  
**OEM**  
**Price: ≤ \$3 / pc**



**ACC-WT-034: Mutoh VJ-1604 / VJ-1618 Encoder Strip**  
Used for VJ-1604 / 1618  
**OEM**  
**Price: ≤ \$32 / pc**



**ACC-WT-035: Mutoh RJ-8000 / RJ-8100 / RH2 Encoder Sensor**  
Used for RJ-8000 / 8100 / RH2  
**OEM**  
**Price: ≤ \$33 / pc**



**ACC-WT-036: Mutoh CR Motor for VJ-1604**  
Used for Mutoh VJ-1604 / VJ-1604W / VJ-1614 / VJ-1608H / 1618K / 1618W / 2606E  
**Original**  
**Price: ≤ \$442 / pc**



**ACC-WT-037: Mutoh CR Encoder Sensor for VJ-1204**  
Used for Mutoh VJ-1204 / 1304 / 1604 / 1604W / 1614 / 1608H / 2606E / RJ-900C  
**Original**  
**Price: ≤ \$71 / pc**



**ACC-WT-040: Mutoh 1618W PF ENC A0 Assembly - DG-41828**  
Used for Mutoh 1604 / 1604W / 1618K / 1618W / 2606E  
**Original**  
**Price: ≤ \$101 / pc**



**ACC-WT-041: Mutoh 1618W PF\_ENC Scale Assembly, DG-40320**  
Used for Mutoh 1604 / 1604W / 1618K / 1618W / 2606E  
**Original**  
**Price: ≤ \$74 / pc**



**ACC-WT-042: Mutoh 1618W Absorbent Sponge (D) Assembly, DG-41085**  
Used for Mutoh 1618K / 1618W  
**Original**  
**Price: ≤ \$110 / pc**



**ACC-WT-043: Mutoh 1618W Cap Head Assembly, DF-49690**  
Used for Mutoh VJ-1204 / 1304 / 1604 / 1618W  
**Original**  
**Price: ≤ \$131 / pc**



**ACC-WT-045: Mutoh RJ-8000 87" Long Data Cable, 4.25m, 30pin**  
Used for Mutoh RJ-8000  
**OEM**  
**Price: ≤ \$32 / pc**



**ACC-WT-046: Mutoh RJ-8000 87" Encoder Strip, 4200mm x 13mm**  
Used for Mutoh RJ-8000  
**OEM**  
**Price: ≤ \$28 / pc**



**ACC-WT-047: Mutoh VJ-1204 / VJ-1604 / VJ-1304 CR Board**  
Used for Mutoh VJ-1204 / 1304 / 1604 / 1604W  
**OEM**  
**Price: ≤ \$105 / pc**



**ACC-WT-049: Mutoh VJ-1618W Cleaner Head Assembly, DF-49687**  
Used for Mutoh VJ-1204 / 1304 / 1604 / 1604W  
**Original**  
**Price: ≤ \$42 / pc**



**ACC-WT-050: Mutoh VJ-1618 Damper Original, DG-41543**  
Used for Mutoh VJ-1618  
**OEM**  
**Price: ≤ \$45 / pc**



**ACC-WT-052: Mutoh VJ-1618 Steel bearer - 41919**  
Used for Mutoh VJ-1618  
**Original**  
**Price: ≤ \$194 / pc**



**ACC-WT-053: Mutoh VJ-1604E / 1304 / 1204 Solvent Printhead Manifold**  
Used for Mutoh VJ-1204 / 1304 / 1604  
**Original**  
**Price: ≤ \$94 / pc**



**ACC-WT-054: Mutoh VJ-1604E / 1304 / 1204 Solvent Printhead Manifold**  
Used for Mutoh VJ-1204 / 1304 / 1604  
**OEM**  
**Price: ≤ \$82 / pc**



**ACC-WT-056: Mutoh VJ-1604 / 900C Cap Sensor**  
Used for Mutoh Mutoh VJ-1604 / 900C  
**OEM**  
**Price: ≤ \$11 / pc**

## &gt; Printer Spare Parts &gt; Mutoh printer spare parts



**ACC-WT-058: Mutoh VJ-1618 Pump Capping Assembly**  
Used for Mutoh VJ-1618  
**Original**  
**Price: ≤ \$421 / pc**



**ACC-WT-059: Mutoh VJ1604E Pump Capping Assembly**  
Used for Mutoh VJ1604E  
**Original**  
**Price: ≤ \$380 / pc**



**ACC-WT-060: Mutoh VJ1604E Damper**  
Used for Mutoh VJ1604E  
**Original**  
**Price: ≤ \$8 / pc**



**ACC-WT-062: Mutoh RJ-6000 Long Data Cable, 2.8m, 40pin**  
Used for Mutoh RJ-6000  
**OEM**  
**Price: ≤ \$36 / pc**



**ACC-WT-063: Mutoh VJ-1604 Fan**  
Used for Mutoh VJ-1604 / 1618 / 1628 / 1638  
**OEM**  
**Price: ≤ \$28 / pc**



**ACC-WT-064: Mutoh Panel Cable for Falcon Outdoor 46 - 90cm, 26pin**  
Used for Mutoh Falcon outdoor 46  
**OEM**  
**Price: ≤ \$12 / pc**



**ACC-WT-065: Mutoh ECO Solvent Ink Pump Tube**  
Used for Roland, Mimaki, Mutoh Printers  
**OEM**  
**Price: ≤ \$3 / m**



**ACC-WT-066: Double ECO Solvent Ink Pump Tube**  
Used for Roland, Mimaki, Mutoh Printers  
**OEM**  
**Price: ≤ \$3 / m**



**ACC-WT-068: Mutoh Valuejet 1604 Wipers**  
Used for Mutoh Valuejet 1604  
**OEM**  
**Price: ≤ \$3 / pc**



**ACC-WT-069: Mutoh Valuejet 1604 Pinch Rollers**  
Used for Mutoh Valuejet 1604  
**OEM**  
**Price: ≤ \$6 / pc**



**ACC-WT-070: Drafstation Flange - Right**  
Used for Mutoh Valuejet 1604  
**Original**  
**Price: ≤ \$41 / pc**



**ACC-WT-071: Drafstation Flange - Left**  
Used for Mutoh Valuejet 1604  
**Original**  
**Price: ≤ \$41 / pc**



**ACC-WT-072: Mutoh Valuejet 1604 Ink Pump Tube**  
Used for Mutoh Valuejet 1604  
**OEM**  
**Price: ≤ \$8 / pc**



**ACC-WT-073: Mutoh Valuejet 1618 bearing**  
Used for Mutoh Valuejet 1618  
**OEM**  
**Price: ≤ \$6 / pc**



**ACC-WT-074: Mutoh Valuejet 1618 Carriage Lock Solenoid Assy. - DG-41076**  
Used for Mutoh Valuejet 1618  
**Original**  
**Price: ≤ \$89 / pc**



**ACC-WT-075: Mutoh Valuejet 1618 Head FFC**  
Used for Mutoh Valuejet 1618  
**Original**  
**Price: ≤ \$42 / pc**



**ACC-WT-076: Mutoh Servo Motor for VJ-1618 / 1628 / 1638**  
Used for Mutoh VJ-1618 / 1628 / 1638  
**OEM**  
**Price: ≤ \$178 / pc**



**ACC-WT-077: Mutoh Servo Motor for RJ-900C / RJ-1300 / 1204 / 1304**  
Used for Mutoh RJ-900C / RJ-1300 / 1204 / 1304  
**OEM**  
**Price: ≤ \$210 / pc**



**ACC-WT-078: Mutoh Rock Hopper Mainboard - Second Hand**  
Used for Mutoh Rock Hopper  
**Original**  
**Price: ≤ \$1,149 / pc**



**ACC-WT-079: Mutoh RJ-8000 Wiper Rubber UV**  
Used for Mutoh RJ8100 / 8000, Rockhopper II / III / Spitfire / Falcon / FalconII / ViperTX  
**OEM**  
**Price: ≤ \$2 / pc**



**ACC-WT-080: Mutoh RJ-8000 Wiper Rubber**  
Used for Mutoh RJ8100 / 8000, Rockhopper II / III / Spitfire / Falcon / FalconII / ViperTX  
**OEM**  
**Price: ≤ \$2 / pc**

## &gt; Printer Spare Parts &gt; Encad printer spare parts



**ACC-NOV-001: Encad NovaJet Mainboard / PCB**  
Used for NovaJet 750 / 700 / 736 / 630 / 600 printers  
**Part Number: 217659**  
**Original**  
**Price: ≤ \$421 / pc**



**ACC-NOV-002: Encad NovaJet Mainboard / PCB**  
Used for NovaJet 750 / 700 / 736 / 630 / 600 printers  
**OEM**  
**Price: ≤ \$291 / pc**



**ACC-NOV-003: Encad NovaJet Paper Sensor for 750**  
Used for NovaJet 500 / 600 / 700 / 750 printers  
**Part Number: 207180**  
**Original**  
**Price: ≤ \$55 / pc**



**ACC-NOV-004: Encad NovaJet Idler Only for All Serials**  
Used for NovaJet 750 / 700 / 736 / 600 / 630 / 60e / 500 / 505 / 880 / 850 / 42e / T200 printers  
**Part Number: 203405**  
**Original**  
**Price: ≤ \$39 / pc**



**ACC-NOV-005: (OEM) Encad NovaJet Idler Only for All Serials**  
Used for NovaJet 750 / 700 / 736 / 600 / 630 / 60e / 500 / 505 / 880 / 850 / 42e / T200 printers  
**OEM**  
**Price: ≤ \$7 / pc**



**ACC-NOV-006: Encad NovaJet 60" Encoder Strip for 700 / 750**  
Used for NovaJet 60e / 505 / 750 / 700 / 600 / 500 printers  
**Part Number: 213565**  
**Original**  
**Price: ≤ \$74pc**



**ACC-NOV-007: Novajet Cradle Idler (Take Up)**  
Used for NovaJet 750 / 700 / 736 / 600 / 630 / 60e / 500 / 505 / 880 / 850 / 42e / T200 printers  
**OEM**  
**Price: ≤ \$5 / pc**



**ACC-NOV-008: Encad NovaJet Carriage PCB**  
Used for NovaJet 750 / 700 / 736 printers  
**Part Number: 212151**  
**Original**  
**Price: ≤ \$194 / pc**



**ACC-NOV-009: Encad NovaJet Carriage PCB**  
Used for NovaJet 750 / 700 / 736 printers  
**OEM**  
**Price: ≤ \$73 / pc**



**ACC-NOV-010-1: Encad NovaJet Carriage Assembly for 850 (right)**  
Used for Encad Novajet 850  
**Part Number: 217564**  
**Original**  
**Price: ≤ \$583 / pc**



**ACC-NOV-010-2: Encad NovaJet Carriage Assembly for 850 (Left)**  
Used for Encad Novajet 850  
**Part Number: 217564**  
**Original**  
**Price: ≤ \$510 / pc**



**ACC-NOV-011: Encad NovaJet Long Data Cable**  
Used for Encad Novajet 850  
**Original**  
**Price: ≤ \$49 / pc**



**ACC-NOV-012: Novajet power board**  
Used for Novajet 750 / 850 / 880 / 505 printer  
**Part Number: 215349**  
**Original**  
**Price: ≤ \$58 / pc**



**ACC-NOV-013: Encad NovaJet Pinch Roller**  
Used for NovaJet 850 / 880 / 750 / 700 / 630 / 600 / 500 / 505 / 60e / 42e / T200 / 736  
**Part Number: 207486**  
**Original**  
**Price: ≤ \$10 / pc**



**ACC-NOV-014: Encad NovaJet Paper Cutter**  
Used for NovaJet 500 / 600 / 630 / 700 / 750 / 850 printers  
**Part Number: 209114**  
**Original**  
**Price: ≤ \$29 / pc**



**ACC-NOV-015: Encad NovaJet Encoder Sensor w / flex for 750**  
Used for NovaJet 60e / 500 / 700 / 750 / 850 printers  
**Part Number: 209578**  
**Original**  
**Price: ≤ \$50 / pc**



**ACC-NOV-016: Encad NovaJet 60" Trailing Data Cable for 750 / 600**  
Used for Encad Novajet 750 / 700 / 630 / 600 / 500 / 505 / 60e 60" printer  
**Part Number: 211194**  
**Original**  
**Price: ≤ \$32 / pc**



**ACC-NOV-017: Encad NovaJet Carriage Board**  
Used for Novajet 850, Novajet 800  
**Original**  
**Price: ≤ \$89 / pc**



**ACC-NOV-018: Encad NovaJet Take Up Cable**  
Used for NovaJet 600, 600e printers  
**Original**  
**Price: ≤ \$6 / pc**



**ACC-NOV-019: Encad NovaJet Network Card for 850**  
Used for NovaJet 850 printers  
**Part Number: 215704**  
**Original**  
**Price: ≤ \$65 / pc**



**ACC-NOV-020: Encad NovaJet Easy Prime Assy**  
Used for NovaJet 600 / 630 / 700 / 750 / 850 / 880 printers  
**Original**  
**Price: ≤ \$324 / pc**



**ACC-NOV-021: Encad NovaJet Keystroke**  
Used for NovaJet 600 / 630 / 700 / 750 / 850 printers  
**Original**  
**Price: ≤ \$74 / pc**



**ACC-NOV-022: Encad NovaJet Servo Motor for 600 / 750**  
Used for Encad NovaJet 750 / 700 / 600 / 630 / 500 / 42e / 60e / T200 / 736 / 505  
**Part Number: 213674**  
**Original**  
**Price: ≤ \$84 / pc**



**ACC-NOV-023: Encad NovaJet Carriage Board for Pro-50**  
Used for NovaJet Pro-50 printers  
**Original**  
**Price: ≤ \$105 / pc**



## &gt; Printer Spare Parts &gt; Encad printer spare parts



**ACC-NOV-024: Encad NovaJet Spring Pad for Pro-50**  
Used for NovaJet Pro-50 printers  
**Original**  
**Price: ≤ \$10 / pc**



**ACC-NOV-025: Encad NovaJet Carriage Flex Cable**  
Used for NovaJet 736 / 750 / 850 / 880 printers  
**Part Number: 215174**  
**Original**  
**Price: ≤ \$57 / pc**



**ACC-NOV-026: Encad NovaJet Carriage Flex Cable**  
Used for NovaJet 700 / 600 / 630 printers  
**OEM**  
**Price: ≤ \$15 / pc**



**ACC-NOV-027: Encad NovaJet Flex Cable Pad for 700E**  
Used for NovaJet 600 / 630 / 700 printers  
**Part Number: 207572**  
**Original**  
**Price: ≤ \$2 / pc**



**ACC-NOV-028: Encad NovaJet Ink Tube for 750**  
Used for NovaJet 500 / 505 / 600 / 630 / 700 / 736 / 750 printers  
**Original**  
**Price: ≤ \$81 / pc**



**ACC-NOV-029: Encad NovaJet Mainboard / PCB for Pro 50**  
Used for NovaJet Pro-50 printers  
**Original**  
**Price: ≤ \$129 / pc**



**ACC-NOV-031: Encad NovaJet Chip Decoder for 850**  
Used for NovaJet 850 printers  
**Original**  
**Price: ≤ \$49 / pc**



**ACC-NOV-032: Encad NovaJet Easy Prime Assy**  
Used for NovaJet 600 / 630 / 700 / 750 / 850 / 880 printers  
**OEM**  
**Price: ≤ \$52 / pc**



**ACC-NOV-033: Encad NovaJet Belt for 850**  
Used for NovaJet 850 / 880 printers  
**Original**  
**Price: ≤ \$194 / pc**



**ACC-NOV-034: Encad Novajet Carriage Partial for 750**  
Used for NovaJet 500 / 505 / 600 / 630 / 700 / 750 printers  
**OEM**  
**Price: ≤ \$32 / pc**



**ACC-NOV-035: Printhead Needle for Encad Novajet 750**  
Used for NovaJet 600 / 630 / 700 / 750 printers  
**Original**  
**Price: ≤ \$13 / pc**



**ACC-NOV-036: Encad NovaJet Carriage Flex Cable for 500**  
Used for NovaJet 500 printers  
**Original**  
**Price: ≤ \$11 / pc**



**ACC-NOV-037: Encad NovaJet Empty Cartridge for 750**  
Used for NovaJet 600 / 630 / 700 / 736 / 750 / 850 / 880 printers  
**Original**  
**Price: ≤ \$58 / pc**



**ACC-NOV-038: Encad NovaJet Fan**  
Used for NovaJet 850 / 880 / 750 / 700 / 630 / 600 / 500 / 505 / 60e / 42e / T200 / 736  
**Original**  
**Price: ≤ \$17 / pc**



**ACC-NOV-039: Encad NovaJet Pump Slot for 850 / 750 / 736**  
Used for NovaJet 850 / 750 / 736 printers  
**Original**  
**Price: ≤ \$6 / pc**

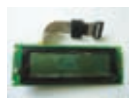

**ACC-NOV-040: Encad NovaJet Key Display for 750**  
Used for NovaJet 600 / 630 / 700 / 750 / 850 printers  
**Original**  
**Price: ≤ \$78 / pc**



**ACC-NOV-041: Encad NovaJet Seal**  
Used for NovaJet 750 / 736 / 700 / 630 / 600 / 500 / T200 printers  
**Part Number: 206502**  
**Original**  
**Price: ≤ \$2 / pc**



**ACC-NOV-042: Encad NovaJet 50" Belt for Pro-50**  
Used for NovaJet Pro-50 printers  
**Part Number: 207475**  
**Original**  
**Price: ≤ \$45 / pc**



**ACC-NOV-043: Encad NovaJet 60" Belt for 750 / 600**  
Used for NovaJet 600 / 630 / 60e / 700 / 736 / 750 / 505 / 500 printers  
**OEM**  
**Price: ≤ \$14 / pc**



**ACC-NOV-044: Encad NovaJet Encoder Strip for 850 / 880**  
Used for NovaJet 850 / 880 printer printers  
**OEM**  
**Price: ≤ \$7 / pc**



**ACC-NOV-045-B: Encad NovaJet Slider Upper for All Encad Serials (Carriage)**  
Used for NovaJet 850 / 880 / 750 / 700 / 630 / 600 / 500 / 505 / 60e / 42e / T200 / 736  
**Part Number: 204654**  
**Original**  
**Price: ≤ \$4 / pc**



**ACC-NOV-046: Encad Novajet 42" Trailing Data Cable for 750 / 600**  
Used for Encad Novajet 750 / 700 / 630 / 600 / 500 / 505 / 60e  
**Part Number: 211195**  
**Original**  
**Price: ≤ \$24 / pc**



**ACC-NOV-047: Encad NovaJet Bushing for All Encad Serials**  
Used for NovaJet 600 / 630 / 500 / 505 / 700 / 750 / 850 / 880 / 60e / 42e  
**Part Number: 209568**  
**OEM**  
**Price: ≤ \$6 / set**



**ACC-NOV-048: Encad NovaJet Service Station for Pro-50**  
Used for NovaJet Pro-50 printers  
**Original**  
**Price: ≤ \$57 / pc**



**ACC-NOV-049: Encad NovaJet Pipeline Interface**  
Used for NovaJet 600 / 630 / 700 / 750 printers  
**Original**  
**Price: ≤ \$2 / pc**



**ACC-NOV-050: Encad NovaJet Paper Jam**  
Used for NovaJet 500 / 600 / 630 / 700 / 750 / 850 printers  
**Original**  
**Price: ≤ \$8 / pc**

## &gt; Printer Spare Parts &gt; Encad printer spare parts



**ACC-NOV-051: Encad NovaJet 60" Encoder Strip for 700 / 750**  
Used for NovaJet 60e / 505 / 750 / 700 / 600 / 500 printers  
**OEM**  
**Price: ≤ \$5 / pc**



**ACC-NOV-052: Encad NovaJet 60" Trailing Data Cable for 750 / 600**  
Used for Encad NovaJet 750 / 700 / 630 / 600 / 500 / 505 / 60e 60" printers  
**OEM**  
**Price: ≤ \$13 / pc**



**ACC-NOV-053: Encad NovaJet Bushing for 1000i / 1200i**  
Used for NovaJet 1000i / 1200i printers  
**OEM**  
**Price: ≤ \$29 / set**



**ACC-NOV-054: Encad NovaJet Servo Motor for 600 / 750**  
Used for Encad NovaJet 750 / 700 / 600 / 630 / 500 / 42e / 60e / T200 / 736 / 505  
**OEM**  
**Price: ≤ \$29 / pc**



**ACC-NOV-055: Novajet Bushing for Encad 1200i / 1000i**  
Used for Encad NovaJet Step Motor for 850 / 880  
**Original**  
**Price: ≤ \$121 / pc**



**ACC-NOV-056: Encad NovaJet Mainboard / PCB for 1000i / 1200i**  
Used for NovaJet 1000i / 1200i printers  
**OEM**  
**Price: ≤ \$485 / pc**



**ACC-NOV-057: Encad NovaJet Carriage Board for 1000i / 1200i**  
Used for NovaJet 1000i / 1200i printers  
**Original**  
**Price: ≤ \$421 / pc**



**ACC-NOV-058: Encad NovaJet Encoder Strip for 1000i / 1200i**  
Used for NovaJet 1000i / 1200i 6 colors inkjet printers  
**OEM**  
**Price: ≤ \$13 / pc**



**ACC-NOV-059: Novajet Trailing Data Cable for 1000i / 1200i**  
Used for NovaJet 1000i / 1200i 6 colors inkjet printers  
**OEM**  
**Price: ≤ \$57 / pc**



**ACC-NOV-062: Encad NovaJet Paper Sensor for 1000i / 1200i**  
Used for Encad 1200i, Encad 1000i  
**OEM**  
**Price: ≤ \$13 / pc**



**ACC-NOV-063: Encad NovaJet Encoder Sensor for 1000i / 1200i**  
Used for Encad 1200i, Encad 1000i  
**OEM**  
**Price: ≤ \$13 / pc**



**ACC-NOV-064: Encad NovaJet Heating Belt for 1000i / 1200i**  
Used for Encad 1200i, Encad 1000i  
**OEM**  
**Price: ≤ \$42 / pc**



**ACC-NOV-065: Encad NovaJet Automatic Paperside Sensor**  
Used for NovaJet 850 printers  
**Original**  
**Price: ≤ \$42 / pc**



**ACC-NOV-066: Encad NovaJet Spindle Hub**  
Used for NovaJet 500 / 505 / 600 / 630 / 700 / 736 / 750 printers  
**Original**  
**Price: ≤ \$5 / pc**



**ACC-NOV-067: Printhead Needle for Encad Novajet 750**  
Used for NovaJet 600 / 630 / 700 / 750 / 850 printers  
**OEM**  
**Price: ≤ \$3 / pc**



**ACC-NOV-068: Encad NovaJet Long Data Cable for 850**  
Used for Encad NovaJet 850  
**OEM**  
**Price: ≤ \$8 / pc**



**ACC-NOV-069: Encad NovaJet Encoder Strip for pro-50**  
Used for NovaJet pro-50 printers  
**Original**  
**Price: ≤ \$26 / pc**



**ACC-NOV-071: Encad NovaJet Chip Decoder for 750**  
Used for NovaJet 750 printers  
**Original**  
**Price: ≤ \$49 / pc**



**ACC-NOV-072: Encad NovaJet Chip Decoder for 1000i / 1200i**  
Used for NovaJet 1000i / 1200i printers  
**OEM**  
**Price: ≤ \$162 / pc**



**ACC-NOV-074: Encad NovaJet Power Board for 1000i / 1200i**  
Used for NovaJet 1000i / 1200i printers  
**Original**  
**Price: ≤ \$154 / pc**



**ACC-NOV-075: Encad NovaJet Service Station for 1000i / 1200i**  
Used for Encad 1200i, Encad 1000i  
**Original**  
**Price: ≤ \$89 / pc**



**ACC-NOV-076: Encad NovaJet Key Display for Pro-50**  
Used for NovaJet Pro-50 printers  
**Original**  
**Price: ≤ \$29 / pc**



**ACC-NOV-077: Encad NovaJet Carriage PCB for 500E**  
Used for NovaJet 500E printers  
**Original**  
**Price: ≤ \$159 / pc**

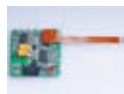

**ACC-NOV-078: Encad NovaJet Paper Sensor for Pro-50**  
Used for NovaJet Pro-50 printers  
**Original**  
**Price: ≤ \$10 / pc**



**ACC-NOV-079: Encad NovaJet Carriage Flex Cable for Pro-50**  
Used for NovaJet Pro-50 printers  
**Original**  
**Price: ≤ \$10 / pc**



**ACC-NOV-080: Encad NovaJet Ink Tube for Pro-50**  
Used for NovaJet Pro-50 printers  
**Original**  
**Price: ≤ \$26 / pc**

## &gt; Printer Spare Parts &gt; Hp printer spare parts



**ACC-HP-001: HP Mainboard / PCB for DesignJet 5000**  
Used for HP DesignJet 5000 machine  
**Original**  
**Price: ≤ \$1,100 / pc**



**ACC-HP-002: HP Mainboard / PCB for DesignJet 1050c**  
Used for HP DesignJet 1050c machine  
**Original**  
**Price: ≤ \$526 / pc**



**ACC-HP-003: HP Mainboard / PCB for DesignJet 130nr**  
Used for HP DesignJet 130nr machine  
**Original**  
**Price: ≤ \$281 / pc**



**ACC-HP-004: HP 42" Encoder Strip for DesignJet 5000 / 5500**  
Used for HP DesignJet 5000 / 5500 machine  
**Original**  
**Price: ≤ \$113 / pc**



**ACC-HP-004-1: HP 60" Encoder Strip for DesignJet 5000 / 5500**  
Used for HP DesignJet 5000 / 5500 machine  
**Original**  
**Price: ≤ \$176 / pc**



**ACC-HP-005: HP Carriage Assembly for DesignJet 5000 / 5500**  
Used for HP DesignJet 5000 / 5500 machine  
**Original**  
**Price: ≤ \$939 / pc**



**ACC-HP-006: HP Carriage Assembly for DesignJet 430 / 450C**  
Used for HP DesignJet 430 / 450C machine  
**Original**  
**Price: ≤ \$246 / pc**



**ACC-HP-007: HP Carriage Assembly for DesignJet 120 / 130**  
Used for HP DesignJet 120 / 130 machine  
**Original**  
**Price: ≤ \$281 / pc**



**ACC-HP-008: HP Power Board for DesignJet 5000 / 5500**  
Used for HP DesignJet 5000 / 5500 machine  
**Original**  
**Price: ≤ \$461 / pc**



**ACC-HP-009: HP Cutter Assy for DesignJet 430 / 450C**  
Used for HP DesignJet 430 / 450C machine  
**Original**  
**Price: ≤ \$38 / pc**



**ACC-HP-010: HP Spindle Hub for DesignJet**  
Used for HP DesignJet 5000, HP DesignJet 5500  
**OEM**  
**Price: ≤ \$11 / pc**



**ACC-HP-011: HP 60" Trailing Data Cable for DesignJet 5000 / 5500**  
Used for HP DesignJet 5000, HP DesignJet 5500  
**Original**  
**Price: ≤ \$202 / pc**



**ACC-HP-013: HP Trailing Data Cable for DesignJet 430 / 450C**  
Used for HP DesignJet 430, HP DesignJet 450  
**Original**  
**Price: ≤ \$94 / pc**



**ACC-HP-014: HP Servo Motor for DesignJet 5000 / 5500**  
Used for HP DesignJet 5000, HP DesignJet 5500  
**Original**  
**Price: ≤ \$202 / pc**



**ACC-HP-015: HP Servo Motor Gear for DesignJet 5000 / 5500**  
Used for HP DesignJet 5000, HP DesignJet 5500  
**OEM**  
**Price: ≤ \$15 / pc**



**ACC-HP-016: HP Line Sensor for DesignJet 5000 / 5500**  
Used for HP DesignJet 5000, HP DesignJet 5500  
**Original**  
**Price: ≤ \$68 / pc**



**ACC-HP-017: HP Roll Replacement Kit for DesignJet 5000 / 5500**  
Used for HP DesignJet 5000, HP DesignJet 5500  
**Original**  
**Price: ≤ \$421 / pc**



**ACC-HP-018: HP 5100 Paper-Axis Motor**  
Used for HP DesignJet 5100 printer  
**Original**  
**Price: ≤ \$194 / pc**



**ACC-HP-019: HP Network Card for DesignJet 5000 / 5500**  
Used for HP DesignJet 5000 / 1050 / 130 machine  
**Original**  
**Price: ≤ \$138 / pc**



**ACC-HP-020: HP Printhead Cleaner for DesignJet 5000 / 5500 / 1050 / 130**  
Used for HP DesignJet 5000 / 5500 / 1050 / 130 printers  
**OEM**  
**Price: ≤ \$13 / pc**



**ACC-HP-021: HP HDD for DesignJet 5000 / 5500**  
Used for HP DesignJet 5000 / 5500 machine  
**OEM**  
**Price: ≤ \$146 / pc**



**ACC-HP-022: HP Refilling Cartridge**  
Used for HP DesignJet 5500 / 5100 / 5000 / 1050 / 1055 / z6100  
**OEM**  
**Price: ≤ \$15 / pc**



**ACC-HP-023: HP Feed Roller Assembly for DesignJet 130nr**  
Used for HP DesignJet 130nr optional part  
**Original**  
**Price: ≤ \$187 / pc**



**ACC-HP-024: HP Cartridge for DesignJet 5500 / 5100**  
Used for HP DesignJet 5000, HP DesignJet 5500  
**OEM**  
**Price: ≤ \$14 / pc**



**ACC-HP-025: Seiko100S Damper**  
Used for Seiko100S  
**OEM**  
**Price: ≤ \$8 / pc**



**ACC-HP-026: HP 60" or 42" Belt for DesignJet 5000 / 5500**  
Used for HP DesignJet 5000, HP DesignJet 5500  
**OEM**  
**Price: ≤ \$44 / pc**



**ACC-HP-027: HP 42" Belt for DesignJet 430 / 450**  
Used for HP DesignJet 430 / 450 machine  
**OEM**  
**Price: ≤ \$32 / pc**



**ACC-HP-028: HP Decipher for DesignJet 5000 / 5500 / 1050**  
Used for HP DesignJet 1050, HP DesignJet 5000, HP DesignJet 5500  
**OEM**  
**Price: ≤ \$43 / pc**



**ACC-HP-029: HP Mainboard / PCB for DesignJet 5500**  
Used for HP5500  
**Original**  
**Price: ≤ \$1,052 / pc**



**ACC-HP-031: Seiko Damper**  
Used for HP9000S, Seiko64S  
**OEM**  
**Price: ≤ \$8 / pc**

## &gt; Printer Spare Parts &gt; Canon printer spare parts



**ACC-CAN-001: Canon IP1880 / IP1980 Pinch Roller Unit**  
Used for Canon PIXMA iP1880 / iP1980  
**Original**  
**Price: ≤ \$9.68 / pc**



**ACC-CAN-002: Canon IP1880 / IP1980 Encoder Strip**  
Used for Canon PIXMA iP1880 / iP1980  
**Original**  
**Price: ≤ \$9.68 / pc**



**ACC-CAN-003: Canon IX5000 / IX4000 Pump Assy**  
Used for Canon PIXMA IX5000 / IX4000  
**Original**  
**Price: \$41.74 / pc**



**ACC-CAN-004: Canon IX4680 Pump Assy**  
Used for Canon PIXMA IX4680  
**Original**  
**Price: ≤ \$75.96 / pc**



**ACC-CAN-005: Canon Image PROGRAF IPF5000 Suction Fan Unit**  
Used for Canon Image PROGRAF IPF5000 / 500  
**Original**  
**Price: ≤ \$103.01 / pc**



**ACC-CAN-006: Canon Image PROGRAF IPF5000 Mist Fan**  
Used for Canon Image PROGRAF IPF5000 / 500  
**Original**  
**Price: ≤ \$50 / pc**



**ACC-CAN-007: Canon Image PROGRAF IPF5000 Ink Supply Unit**  
Used for Canon Image PROGRAF IPF5000  
**Original**  
**Price: ≤ \$278.80 / pc**



**ACC-CAN-008: Canon Image PROGRAF IPF5000 Carriage Unit**  
Used for Canon Image PROGRAF IPF5000  
**Original**  
**Price: ≤ \$358 / pc**



**ACC-CAN-009: Canon Image PROGRAF IPF5000 Operation Panel Unit**  
Used for Canon Image PROGRAF IPF5000  
**Original**  
**Price: ≤ \$101.35 / pc**



**ACC-CAN-010: Canon Image PROGRAF IPF5000 Power Supply Assy**  
Used for Canon Image PROGRAF IPF5000 / 510 / 500 (100 / 120V)  
**Original**  
**Price: ≤ \$133.69 / pc**



**ACC-CAN-011: Canon Image PROGRAF IPF5000 Purge Unit**  
Used for Canon Image PROGRAF IPF5100 / 5000  
**Original**  
**Price: ≤ \$264.12 / pc**



**ACC-CAN-013: Canon Image PROGRAF IPF5000 Cutter Drive Unit**  
Used for Canon Image PROGRAF IPF5100 / 5000 / 510 / 500  
**Original**  
**Price: ≤ \$54.04 / pc**



**ACC-CAN-014: Canon Image PROGRAF IPF5000 Head Management Sensor**  
Used for Canon Image PROGRAF IPF5100 / 5000 / 510 / 500  
**Original**  
**Price: ≤ \$40.15 / pc**



**ACC-CAN-015: Canon Image PROGRAF IPF5000 Main Board**  
Used for Canon Image PROGRAF IPF5000  
**Original**  
**Price: ≤ \$960 / pc**



**ACC-CAN-016: Canon Image PROGRAF IPF5000 Pinch Roller Unit**  
Used for Canon Image PROGRAF IPF5000 / 500  
**Original**  
**Price: ≤ \$17.53 / pc**



**ACC-CAN-017: Canon I Image PROGRAF PF5000 Idler Pulley Unit**  
Used for Canon Image PROGRAF IPF5100 / 5000 / 510 / 500  
**Original**  
**Price: ≤ \$14.69 / pc**



**ACC-CAN-019: Canon Image PROGRAF IPF8000 Ink Tank Unit L**  
Used for Canon Image PROGRAF IPF8000  
**Original**  
**Price: ≤ \$333 / pc**



**ACC-CAN-020: Canon Image PROGRAF IPF8000 Carriage Motor**  
Used for Canon Image PROGRAF IPF8000 / 8100 / 8000S  
**Original**  
**Price: ≤ \$158.60 / pc**



**ACC-CAN-021: Canon Image PROGRAF IPF8000 Carriage Relay Pcb Assy**  
Used for Canon Image PROGRAF IPF8000  
**Original**  
**Price: ≤ \$291.69 / pc**



**ACC-CAN-022: Canon Image PROGRAF IPF8000 Feed Motor Assy**  
Used for Canon Image PROGRAF IPF8000  
**Original**  
**Price: ≤ \$58.60 / pc**



**ACC-CAN-023: Canon Image PROGRAF IPF8000 Lift Drive Unit**  
Used for Canon Image PROGRAF IPF8000 / 8100 / 8000S  
**Original**  
**Price: ≤ \$46.74 / pc**



**ACC-CAN-024: Canon Image PROGRAF IPF8000 Lever Release**  
Used for Canon Image PROGRAF IPF8000 / 8100 / 8000S  
**Original**  
**Price: ≤ \$17.63 / pc**



**ACC-CAN-025: Canon Image PROGRAF IPF8000 Operation Panel Unit**  
Used for Canon Image PROGRAF IPF8000  
**Original**  
**Price: ≤ \$254.14 / pc**



**ACC-CAN-026: Canon Image PROGRAF IPF8000 M / C Relay PCB Assy**  
Used for Canon Image PROGRAF IPF8000  
**Original**  
**Price: ≤ \$21.7 / pc**



**ACC-CAN-027: Canon Image PROGRAF IPF8000 Encoder Pulley**  
Used for Canon Image PROGRAF IPF8000  
**Original**  
**Price: ≤ \$28.38 / pc**

## &gt; Printer Spare Parts &gt; Canon printer spare parts



**ACC-CAN-028: Canon Image PROGRAF IPF700 Carriage Unit**  
Used for Canon Image PROGRAF IPF700  
**Original**  
**Price: ≤ \$431 / pc**



**ACC-CAN-029: Canon Image PROGRAF IPF8000 Flexible Cable**  
Used for Canon Image PROGRAF IPF8000  
**Original**  
**Price: ≤ \$135.86 / pc**



**ACC-CAN-030: Canon Image PROGRAF IPF700 Carriage Board**  
Used for Canon Image PROGRAF IPF700  
**Original**  
**Price: ≤ \$178.83 / pc**



**ACC-CAN-031: Canon Image PROGRAF IPF5000 M / C Relay PCB**  
Used for Canon Image PROGRAF IPF500 / 510 / 600 / 610 / 5000 / 5100 / 6100  
**Original**  
**Price: ≤ \$16.69 / pc**



**ACC-CAN-032: Canon Image PROGRAF IPF8000 Main Board**  
Used for Canon Image PROGRAF IPF8000  
**Original**  
**Price: ≤ \$1,354 / pc**



**ACC-CAN-033: Canon Image PROGRAF W6200 Engine Controller Board**  
Used for Canon Image PROGRAF W6200  
**Original**  
**Price: ≤ \$838 / pc**



**ACC-CAN-034: Canon Image PROGRAF W6200 Power Supply Unit**  
Used for Canon Image PROGRAF W6200  
**Original**  
**Price: ≤ \$399 / pc**



**ACC-CAN-035: Canon Image PROGRAF W6200 System Controller Board**  
Used for Canon Image PROGRAF W6200  
**Original**  
**Price: ≤ \$1,212 / pc**



**ACC-CAN-036: Canon Image PROGRAF W6200 Carriage Board**  
Used for Canon Image PROGRAF W6200  
**Original**  
**Price: ≤ \$550 / pc**



**ACC-CAN-037: Canon Image PROGRAF W6200 Encoder Slit**  
Used for Canon Image PROGRAF W6200  
**Original**  
**Price: ≤ \$31.72 / pc**



**ACC-CAN-038: Canon Image PROGRAF W6200 Feed Roller Sensor**  
Used for Canon Image PROGRAF W6200  
**Original**  
**Price: ≤ \$25.88 / pc**



**ACC-CAN-039: Canon Image PROGRAF W6200 Suction Fan**  
Used for Canon Image PROGRAF W6200  
**Original**  
**Price: ≤ \$124.14 / pc**



**ACC-CAN-040: Canon Image PROGRAF W6200 Purge Unit**  
Used for Canon Image PROGRAF W6200  
**Original**  
**Price: ≤ \$348 / pc**



**ACC-CAN-041: Canon Image PROGRAF W6200 Feed Motor**  
Used for Canon Image PROGRAF W6200  
**Original**  
**Price: ≤ \$94.49 / pc**



**ACC-CAN-042: Canon Image PROGRAF W6200 Carriage Motor**  
Used for Canon Image PROGRAF W6200  
**Original**  
**Price: ≤ \$171.89 / pc**



**ACC-CAN-043: Canon Image PROGRAF W6200 Flexible Cable**  
Used for Canon Image PROGRAF W6200  
**Original**  
**Price: ≤ \$56.64 / pc**



**ACC-CAN-044: Canon Image PROGRAF W6200 Release Lever**  
Used for Canon Image PROGRAF W6200  
**Original**  
**Price: ≤ \$18.70 / pc**



**ACC-CAN-045: Canon Image PROGRAF IPF8000 Pinch Roller Unit**  
Used for Canon Image PROGRAF IPF8000 / 8100 / 8000S  
**Original**  
**Price: ≤ \$35.89 / pc**



**ACC-CAN-046: Canon Image PROGRAF IPF500 Control Panel**  
Used for Canon Image PROGRAF IPF500  
**Original**  
**Price: ≤ \$86.81 / pc**



**ACC-CAN-047: Canon Image PROGRAF IPF500 Carriage Unit**  
Used for Canon Image PROGRAF IPF500  
**Original**  
**Price: ≤ \$259.93 / pc**



**ACC-CAN-048: Canon Image PROGRAF IPF500 Ink Supply Unit**  
Used for Canon Image PROGRAF IPF500  
**Original**  
**Price: ≤ \$254.41 / pc**



**ACC-CAN-049: Canon Image PROGRAF W6200 Mist Fan**  
Used for Canon Image PROGRAF W6200  
**Original**  
**Price: ≤ \$81.17 / pc**



**ACC-CAN-050: Canon Image PROGRAF IPF8000 Suction Fan Unit**  
Used for Canon Image PROGRAF IPF8000  
**Original**  
**Price: ≤ \$128.5 / pc**



**ACC-CAN-051: Canon Image PROGRAF W3000 Purge Unit**  
Used for Canon Image PROGRAF W3000  
**Original**  
**Price: ≤ \$317 / pc**

## &gt; Printer Spare Parts &gt; Seiko / Liyu / GongZheng printer spare parts



**ACC-LFP-001: Small Ink Pump for Sino - printer**  
Used for YSL, LiYu, Gongzheng, Infiniti and other sino - printers  
OEM  
**Price: ≤ \$4.17 / pc**



**ACC-LFP-005: Metal Air Bottle**  
Used for YSL / Wit - color / LiYu, gongzheng, Infiniti printers  
OEM  
**Price: ≤ \$15.68 / pc**



**ACC-LFP-006: Plastic Ink Level Sensor**  
Used for YSL / Wit - Color, LiYu, Gongzheng, Infiniti printers  
OEM  
**Price: ≤ \$5.01 / pc**



**ACC-LFP-007: Stainless Steel Ink Level Sensor**  
Used for YSL, Wit - Color, LiYu, Gongzheng, Infiniti printers  
OEM  
**Price: ≤ \$6.68 / pc**



**ACC-LFP-010: LiYu Plastic Sub - ink Tank**  
Used for LiYu  
OEM  
**Price: ≤ \$20.03 / pc**



**ACC-LFP-012: A Filter for Sino - printers**  
Used for YSL, Wit - Color, LiYu, Gongzheng, Infiniti, etc.  
OEM  
**Price: ≤ \$3.67 / pc**



**ACC-LFP-013: B Filter for Sino - printers**  
Used for YSL, Wit - Color, LiYu, Gongzheng, Infiniti, etc.  
OEM  
**Price: ≤ \$2.67 / pc**



**ACC-LFP-014: C Filter for Sino - printers**  
Used for YSL, Wit - Color, LiYu, Gongzheng, Infiniti, etc.  
Original  
**Price: ≤ \$2.00 / pc**



**ACC-LFP-015: Capsule Filter for Sino - printers**  
Used for LiYu, Myjet, etc  
OEM  
**Price: ≤ \$18.36 / pc**



**ACC-LFP-016: Main Ink-box Filter for Sino - printers**  
Used for YSL, Wit - Color, LiYu, Gongzheng, Infiniti etc.  
OEM  
**Price: ≤ \$4.67 / pc**



**ACC-LFP-017: Solenoid Valve for Sino - printers**  
Used for YSL, Wit - Color, LiYu, Gongzheng, and Infiniti printers, etc.  
OEM  
**Price: ≤ \$6.68 / pc**



**ACC-LFP-018: Manual Two - Way / Three - Way Valve (Plastic)**  
Used for YSL, Wit - Color, LiYu, Gongzheng, Infiniti, etc.  
OEM  
**Price: ≤ \$5.01 / pc**



**ACC-LFP-019: Manual Two - Way / Three - Way Valve for Sino - Printers (Metal)**  
Used for YSL, Wit - Color, LiYu, Gongzheng, Infiniti, etc.  
OEM  
**Price: ≤ \$11.69 / pc**



**ACC-LFP-020: Plastic Cleaning System for Sino - printers**  
Used for YSL, Wit - Color, LiYu, Gongzheng, Infiniti, etc.  
OEM  
**Price: ≤ \$40.07 / pc**



**ACC-LFP-021: Aluminium Cleaning System for Sino - printers**  
Used for YSL, Wit - Color, LiYu, Gongzheng, Infiniti, etc.  
OEM  
**Price: ≤ \$80.13 / pc**



**ACC-LFP-022: Stainlee Steel Cleaning System for Sino - printers**  
Used for YSL, Wit - Color, LiYu, Gongzheng, Infiniti, etc.  
OEM  
**Price: ≤ \$80.13 / pc**



**ACC-LFP-023: Non-woven Cloth for Sino - printers**  
Used for YSL, Wit - Color, LiYu, Gongzheng, Infiniti, etc.  
OEM  
**Price: ≤ \$10.02 / pc**



**ACC-LFP-024: Imported Non-woven Cloth for Sino - printers**  
Used for YSL, Wit - Color, LiYu, Gongzheng, Infiniti, etc.  
OEM  
**Price: ≤ \$8.35 / pc**



**ACC-LFP-028: Big Ink Pump for Sino - printers**  
Used for YSL, LiYu, Gongzheng, Infiniti and other sino - printers  
OEM  
**Price: ≤ \$10.85 / pc**



**ACC-LFP-030: Ink Box for Seiko / Konica Head Printers**  
Used for seiko / Konica  
OEM  
**Price: ≤ \$11.69 / pc**



**ACC-LFP-184: Air or Vacuum Pump for Wide Format Printers**  
Used for YSL, LiYu, Gongzheng, Infiniti and other sino - printers  
OEM  
**Price: ≤ \$10.85 / pc**



**ACC-GZ-018: Thunder Jet V1801 / 1802 Printhead Board**  
Used for Thunder Jet V1801 / 1802 Printer  
Original  
**Price: ≤ \$410.00 / pc**



**ACC-GZ-019: Thunder Jet V1801/1802 Mainboard**  
Used for Thunder Jet V1801 / 1802 Printer  
Original  
**Price: ≤ \$821 / pc**

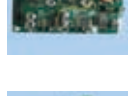

**ACC-GZ-020: Thunder Jet V1801 / 1802 Printhead Driver Board**  
Used for Thunder Jet V1801 / 1802 Printer  
Original  
**Price: ≤ \$308 / pc**



**ACC-GZ-021: GZT3202 / 3204 / 3208AU Printer Printhead Connector Board**  
Used for GZT3202 / 3204 / 3208AU Printer  
Original  
**Price: ≤ \$164.27 / pc**



**ACC-GZ-022: GZT3208AU Printer Mainboard**  
Used for GZT3208AU Printer  
Original  
**Price: ≤ \$1026.00 / pc**



**ACC-GZ-023: GZT3208AU Printer Printhead Board**  
Used for GZT3208AU Printer  
Original  
**Price: ≤ \$1026.00 / pc**



**ACC-GZ-041: ThunderJet A1801 / A1802 / 1802S Printers Cap Capping Top**  
Used for GONGZHENG ThunderJet A1802 / A1801 / A1802S / A1801S / A2502 / A2502S, ThunderJet V1802S / V1801S / V1802 / V1801  
OEM  
**Price: ≤ \$15.03 / pc**

## &gt; Printer Spare Parts &gt; Seiko / Liyu / GongZheng printer spare parts



**ACC-LY-001: Liyu PM2512 / PM3212 Printer Printhead Board**  
Used for Liyu PM2512 / PM3212 Printer  
OEM  
**Price: ≤ \$108.51 / pc**



**ACC-LY-002: Liyu PG2512 / PG3212 Printer Printhead Board**  
Used for Liyu PG3212 / PG2512 Printer  
OEM  
**Price: ≤ \$108.51 / pc**



**ACC-LY-003: LIYU PM1808 / 2508 / 3208 Printer Printhead Board**  
Used for Liyu PM1808 / 2508 / 3208 Printer  
OEM  
**Price: ≤ \$100.17 / pc**



**ACC-LY-004: Liyu PG1808 / 2508 / 3208 Printer Printhead Board**  
Used for Liyu PG1808 / 2508 / 3208 Printer  
OEM  
**Price: ≤ \$100.17 / pc**

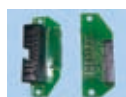

**ACC-LY-005: Liyu PM / PG / PY Series Printer Xaar128 Printhead Transfer Board**  
Used for PM2512 / PM3212 / PM1808 / PM2508 / PM3208 Printer  
OEM  
**Price: ≤ \$5.01 / pc**



**ACC-LY-006: Liyu PM / PG / PY Series Printer 16 Pin Printhead Cable**  
Used for Liyu PM2512 / PM3212, PM1808 / PM2508 / PM3208 Printer  
OEM  
**Price: ≤ \$5.01 / pc**



**ACC-LY-007: Liyu PM / PG / PY Series Printer 14 Pin Date Cable**  
Used for Liyu PM2512 / PM3212, PM1808 / PM2508 / PM3208 Printer  
OEM  
**Price: ≤ \$10.02 / pc**



**ACC-LY-008: Liyu PM / PG / PY Series Printer PCI Card Date Cable**  
Used for Liyu PM2512 / PM3212 Printer, PM1808 / PM2508 / PM3208 Printer  
OEM  
**Price: ≤ \$41.74 / pc**



**ACC-LY-009: Liyu PM / PG Series Printer Ink Filter**  
Used for Liyu PM2512 / PM3212 Printer  
OEM  
**Price: ≤ \$22.54 / pc**



**ACC-LY-010: Liyu PY2508 / 3208 / 3212 Printer Ink Filter**  
Used for Liyu PY2508 / 3208 / 3212 Printer  
OEM  
**Price: ≤ \$21.70 / pc**



**ACC-LY-011: Liyu PM / PG / PY Series Printer Ink Level Sensor**  
Used for Liyu PM2512 / PM3212 / PM1808 / PM2508 / PM3208 Printer  
OEM  
**Price: ≤ \$10.02 / pc**



**ACC-LY-012: Liyu PH / PG / PM Series Printer Servo Motor**  
Used for Liyu PM2512 / PM3212 Printer  
OEM  
**Price: ≤ \$133.56 / pc**



**ACC-LY-013: Liyu PM2512 / PM3312 / PM1808 / PM2508 / PM3208 Printer Long Belt**  
Used for Liyu PM2512 / PM3312 / PM1808 / PM2508 / PM3208 Printer  
OEM  
**Price: ≤ \$41.74 / pc**



**ACC-LY-014: Liyu PH / PG / PM Series Printer Sensor**  
Used for Liyu PM2512 / PM3212 / PM1808 / PM2508 / PM3208 Printer  
OEM  
**Price: ≤ \$7.51 / pc**



**ACC-LY-015: Liyu PG / PY Series Printer Optical Fiber**  
Used for Liyu PG2512 / PG3212 / PG1808 / PG2508 / PG3208 Printer  
OEM  
**Price: ≤ \$7.51 / pc**



**ACC-LY-016: Liyu PG Series Printer Long Belt**  
Used for LIYU PG2512 / PG3212 / PG1808 / PG2508 / PG3208 Printer  
OEM  
**Price: ≤ \$41.74 / pc**



**ACC-LY-017: Liyu PY / POP Series Printer Long Belt**  
Used for Liyu PY3208 / PY3212 / POP3208E Printer  
OEM  
**Price: ≤ \$45.08 / pc**



**ACC-LY-018: Liyu PH / PG / PM Series Printer 89XL Belt**  
Used for Liyu PM2512 / PM3212 / PM1808 / PM2508 / PM3208 Printer  
OEM  
**Price: ≤ \$5.84 / pc**



**ACC-LY-019: Liyu PH / PG / PM Series Printer Step Motor**  
Used for Liyu PM2512 / PM3312 / PM1808 / PM2508 / PM3208 Printer  
OEM  
**Price: ≤ \$58.43 / pc**



**ACC-LY-020: Liyu PH / PG / PM Series Printer Drag Chain**  
Used for Liyu PM2512 / PM3312 / PM1808 / PM2508 / PM3208 Printer  
OEM  
**Price: ≤ \$33.39 / pc**



**ACC-LY-021: Liyu POP3208E Printer Optical Fiber**  
Used for Liyu POP3208E Printer  
OEM  
**Price: ≤ \$7.51 / pc**



**ACC-LY-022: Liyu PY / POP Series Printer Encoder Sensor**  
Used for Liyu PY2508 / PY3208 / PY3212 Printer / POP3208E Printer  
OEM  
**Price: ≤ \$16.69 / pc**

## &gt; Printer Spare Parts &gt; Infiniti printer spare parts



**ACC-LFP-002: Infiniti / Challenger Printer Servo Board**  
Used for Infiniti / Challenger FY-3208S Printer  
**Original**  
**Price: ≤ \$112.69 / pc**



**ACC-LFP-004: Infiniti / Challenger FY3206 Printer PCI Card**  
Used for Infiniti / Challenger FY-3206B Printer  
**Original**  
**Price: ≤ \$368.00 / pc**



**ACC-LFP-008: Infiniti / Challenger Printer 14pin Data Cable**  
Used For Infiniti / Challenger Printer  
**OEM**  
**Price: ≤ \$10.02 / pc**



**ACC-LFP-009: Stainless Steel Ink Level Sensor for Infiniti / Challenger Printer**  
Used for Infiniti / Challenger Printer  
**OEM**  
**Price: ≤ \$8.35 / pc**



**ACC-LFP-011: Shielded Data Cable 14pin for Infiniti / Challenger Printer**  
Used for Infiniti / Challenger Printer  
**OEM**  
**Price: ≤ \$10.02 / pc**



**ACC-LFP-025: Infiniti / Challenger Printer 126 Printhead Cable**  
Used for Infiniti / Challenger Printer  
**OEM**  
**Price: ≤ \$3.34 / pc**



**ACC-LFP-027: Infiniti / Challenger Xaar128 Printer Printhead Connector**  
Used for Infiniti / Challenger Printer  
**OEM**  
**Price: ≤ \$5.34 / pc**



**ACC-LFP-029: Empty Ink Box for Infiniti / Challenger Printer**  
Used for Infiniti / Challenger Printer  
**OEM**  
**Price: ≤ \$10.85 / pc**



**ACC-LFP-031: Infiniti / Challenger FY-3206 Printer Carriage Board**  
Used for Infiniti / Challenger FY-3206 Printer  
**Original**  
**Price: ≤ \$285.48 / pc**



**ACC-LFP-034: Infiniti / Challenger Printer Power Supply**  
Used for all Infiniti / Challenger Printer  
**Original**  
**Price: ≤ \$200.33 / pc**



**ACC-LFP-035: Seiko printhead transfer Board for Infiniti / Challenger Printer**  
Used For Infiniti / Challenger FY-3208HA / 3206B / 3206HA / 323B Printer  
**Original**  
**Price: ≤ \$51.75 / pc**



**ACC-LFP-036: Feeding Media control board for Infiniti / Challenger Printer**  
Used for all Infiniti / Challenger Printer  
**Original**  
**Price: ≤ \$63.44 / pc**



**ACC-LFP-037: Infiniti / Challenger Printer Step Motor**  
Used for all Infiniti / Challenger Printer  
**Original**  
**Price: ≤ \$116.86 / pc**



**ACC-LFP-038: Infiniti / Challenger Printer Motor Driver**  
Used for all Infiniti / Challenger Printer  
**Original**  
**Price: ≤ \$133.56 / pc**



**ACC-LFP-039: Infiniti / Challenger Printer Servo Board**  
Used for all Infiniti / Challenger Printer  
**Original**  
**Price: ≤ \$140.23 / pc**



**ACC-LFP-040: Infiniti / Challenger FY-3208 Printer PCI Card**  
Used for Infiniti / Challenger FY-3208 Printer  
**Original**  
**Price: ≤ \$400.00 / pc**



**ACC-LFP-041: Infiniti / Challenger FY-3208 printer Carriage Board**  
Used for Infiniti / Challenger FY-3208 printer  
**Original**  
**Price: ≤ \$303.00 / pc**



**ACC-LFP-042: Infiniti / Challenger FY-3206B Printer Servo Motor**  
Used for Infiniti / Challenger FY-3206B Printer  
**Original**  
**Price: ≤ \$217.03 / pc**



**ACC-LFP-043: Seiko SPT255 Printhead Damper**  
Used for Infiniti / Challenger FY-252HF / 740F / 183BF Printer  
**Original**  
**Price: ≤ \$61.77 / pc**



**ACC-LFP-045: Seiko SPT510 Printhead Damper**  
Used for Infiniti / Challenger FY-3208S / 3206 / 3206B / 323B Printer  
**OEM**  
**Price: ≤ \$29.38 / pc**



**ACC-LFP-048: Infiniti / Challenger Printer Head Rack (Large)**  
Used for all Infiniti / Challenger Printer  
**Original**  
**Price: ≤ \$70.12 / pc**



**ACC-LFP-053: Infiniti / Challenger Printer Servo Motor Gear**  
Used for all Infiniti / Challenger Printer  
**Original**  
**Price: ≤ \$19.53 / pc**



**ACC-LFP-056: Infiniti / Challenger FY-3208 Printer Pinch Roller**  
Used for Infiniti / Challenger FY-3208 Printer  
**Original**  
**Price: ≤ \$15.03 / pc**



**ACC-LFP-057: Infiniti / Challenger Printer Strut Handle**  
Used for all Infiniti / Challenger Printer  
**Original**  
**Price: ≤ \$9.18 / pc**



**ACC-LFP-058: Infiniti / Challenger Printer High Dense Wire(3M)**  
Used for Infiniti / Challenger Printer  
**Original**  
**Price: ≤ \$28.05 / pc**



**ACC-LFP-059: Infiniti / Challenger Printer Fiber Wire (6m)**  
Used for all Infiniti / Challenger Printer  
**Original**  
**Price: ≤ \$20.03 / pc**



**ACC-LFP-060: Infiniti / Challenger Printer Media Sensor**  
Used for all Infiniti / Challenger Printer  
**Original**  
**Price: ≤ \$65.00 / pc**



## &gt; Printer Spare Parts &gt; Infiniti printer spare parts



**ACC-LFP-062: Infiniti / Challenger FY-3206B Printer Switch**  
Used for Infiniti / Challenger FY-3206B Printer  
**Original**  
**Price: ≤ \$42.07 / pc**



**ACC-LFP-063: Infiniti / Challenger FY-3208 Printer Encoder Sensor**  
Used for Infiniti / Challenger FY-3208 Printer  
**Original**  
**Price: ≤ \$25.04 / pc**



**ACC-LFP-064: Infiniti / Challenger Printer Fiber Joint**  
Used for all Infiniti / Challenger Printer  
**Original**  
**Price: ≤ \$7.01 / pc**



**ACC-LFP-065: Infiniti / Challenger Printer Encoder Strip**  
Used for Infiniti / Challenger FY-206B, FY-3208H Printer  
**Original**  
**Price: ≤ \$22.54 / pc**



**ACC-LFP-066: Infiniti / Challenger FY3206 Printer Pinch Roller**  
Used for Infiniti / Challenger FY-3206 Printer  
**Original**  
**Price: ≤ \$25.71 / pc**



**ACC-LFP-069: Infiniti / Challenger FY3206 Printer Head Rack(Small)**  
Used for Infiniti / Challenger FY-3206 Printer  
**Original**  
**Price: ≤ \$76.62 / pc**



**ACC-LFP-071: Infiniti / Challenger FY-8250B Printer Printhead Board**  
Used for Infiniti / Challenger FY-8250B / FY-3308B / FY-8320B  
**Original**  
**Price: ≤ \$142.24 / pc**



**ACC-LFP-072: Infiniti / Challenger FY-33VB Printer Printhead Board**  
Used for Infiniti / Challenger FY-33VB Printer  
**Original**  
**Price: ≤ \$142.24 / pc**



**ACC-LFP-073: Infiniti / Challenger FY-8250C Printer Printhead Board**  
Used for Infiniti / Challenger FY-33VC+ / 3308C / 1504C / 6150C Printer  
**Original**  
**Price: ≤ \$174.96 / pc**



**ACC-LFP-074: Infiniti / Challenger FY-33VC Printer Printhead Board**  
Used for Infiniti / Challenger FY-3312C / FY-33VC Printer  
**Original**  
**Price: ≤ \$207.85 / pc**



**ACC-LFP-075: Infiniti / Challenger FY-3360EC Printer Printhead Board**  
Used for Infiniti / Challenger FY-3360EC Printer  
**Original**  
**Price: ≤ \$174.96 / pc**



**ACC-LFP-076: Infiniti / Challenger FY-33VB Printer USB Board**  
Used for Infiniti / Challenger FY-8320B / 8320C / 3360EC / 3312C / 33VB / 33VC / 33VC+ / 6250LQ / 8250B / 8250C Printer  
**Original**  
**Price: ≤ \$142.24 / pc**



**ACC-LFP-077: Infiniti / Challenger USB Transfer Board**  
Used for Infiniti / Challenger FY-33VB / 33VC+ Printer  
**Original**  
**Price: ≤ \$50.25 / pc**



**ACC-LFP-078: Infiniti / Challenger FY-3312C Printer Main Board**  
Used for Infiniti / Challenger FY-33VC / 6250LQ / 3312C / 8320B Printer  
**Original**  
**Price: ≤ \$393.00 / pc**



**ACC-LFP-079: Infiniti / Challenger FY-33VB Printer Main Board**  
Used for Infiniti / Challenger FY-33VB / 33VC+ Printer  
**Original**  
**Price: ≤ \$415.00 / pc**



**ACC-LFP-080: Infiniti / Challenger FY-33VB Printer AUX Board**  
Used for Infiniti / Challenger FY-33VB / 33VC+ Printer  
**Original**  
**Price: ≤ \$328.00 / pc**



**ACC-LFP-105: Infiniti / Challenger FY-3312C Ink & Heating Control Board**  
Used for Infiniti / Challenger FY-3360EC / 8320C / 8320B / 8320C / 3312C  
**Original**  
**Price: ≤ \$87.48 / pc**



**ACC-LFP-106: Infiniti / Challenger FY-33VC Printer Ink & Heating Control Board**  
Used for Infiniti / Challenger FY-33VC / 6250LQ / 8250B / 8250C  
**Original**  
**Price: ≤ \$185.98 / pc**



**ACC-LFP-107: Infiniti / Challenger FY-33VB Printer Motor Driver Board**  
Used for Infiniti / Challenger FY-33VB / 33VC+ / 33VC  
**Original**  
**Price: ≤ \$258.10 / pc**



**ACC-LFP-108: Infiniti / Challenger FY-33VB Printer Media Take-up Board**  
Used for Infiniti / Challenger FY-33VB / 33VC / 33VC+  
**Original**  
**Price: ≤ \$72.12 / pc**



**ACC-LFP-109: Infiniti / Challenger Printer Display Panel Assy**  
Used for Infiniti / Challenger FY-8320B / 8320C / 3360EC / 3312C / 33VB / 33VC / 33VC+ / 6250LQ / -8250B / 8250C  
**Original**  
**Price: ≤ \$150.00 / pc**



**ACC-LFP-110: Infiniti / Challenger Auto Cleaning Panel Board**  
Used for Infiniti / Challenger FY-8320C / 8320B / 8320C / 3312C / 8320C  
**Original**  
**Price: ≤ \$61.27 / pc**



**ACC-LFP-112: Infiniti / Challenger ACS806-02 AC Motor Driver**  
Used for Infiniti / Challenger FY-3208HA / 3206HA  
**Original**  
**Price: ≤ \$292.99 / pc**



**ACC-LFP-114: Infiniti / Challenger AMT806 AC Motor Driver**  
Used for Infiniti / Challenger  
**Original**  
**Price: ≤ \$292.99 / pc**



**ACC-LFP-116: Infiniti / Challenger 6 Heads 35PL Printhead Board**  
Used for Infiniti / Challenger FY-3206HA / 3206HF / 3206H / 3206R / 3206G  
**Original**  
**Price: ≤ \$333.00 / pc**



**ACC-LFP-117: Infiniti / Challenger 6 Heads 50PL Printhead Board**  
Used for Infiniti / Challenger FY-3276HA / 3276R  
**Original**  
**Price: ≤ \$333.00 / pc**

## &gt; Printer Spare Parts &gt; Infiniti printer spare parts



**ACC-LFP-118: Infiniti / Challenger 8 Heads 35PL Printhead Board**  
Used for Infiniti / Challenger FY-3208HA / 3208HF / 3208H / 3208G / 3208R  
**Original**  
**Price: ≤ \$350.00 / pc**



**ACC-LFP-119: Infiniti / Challenger 8 Heads 50PL Printhead Board**  
Used for Infiniti / Challenger FY-3278N / 3278F / 3208F  
**Original**  
**Price: ≤ \$350.00 / pc**



**ACC-LFP-120: Infiniti / Challenger 6 Heads 35PL Main Board**  
Used for Infiniti / Challenger FY-3206HA / 3206HF / 3206H / 3206R / 3206G  
**Original**  
**Price: ≤ \$367.00 / pc**



**ACC-LFP-121: Infiniti / Challenger 6 Heads 50PL Main Board**  
Used for Infiniti / Challenger FY-3276HA / 3276R  
**Original**  
**Price: ≤ \$367.00 / pc**



**ACC-LFP-122: Infiniti / Challenger 8 Heads 35PL Main Board**  
Used for Infiniti / Challenger FY-3208HA / 3208HF / 3208H / 3208G / 3208R  
**Original**  
**Price: ≤ \$367.00 / pc**



**ACC-LFP-123: Infiniti / Challenger 8 Heads 50PL Main Board**  
Used for Infiniti / Challenger FY-3278N / 3278 / 3208F  
**Original**  
**Price: ≤ \$367.00 / pc**



**ACC-LFP-124: Infiniti / Challenger 6 Heads I / O Board**  
Used for Infiniti / Challenger FY-3206HA / 3206HF / 3206H / 3206R / 3206G / 3276HA / 3276R  
**Original**  
**Price: ≤ \$217.03 / pc**



**ACC-LFP-125: Infiniti / Challenger 8 Heads I / O Board**  
Used for Infiniti / Challenger FY-3208HA / 3208HF / 3208H / 3208G / 3208R / 3278N / 3278F / 3208F  
**Original**  
**Price: ≤ \$217.03 / pc**



**ACC-LFP-126: Infiniti / Challenger USB I / F Board**  
Used for All Infiniti / Challenger Seiko Printhead USB Printers  
**Original**  
**Price: ≤ \$59.27 / pc**



**ACC-LFP-127: Infiniti / Challenger Sync 354 Belt**  
Used for All Infiniti / Challenger Seiko Printhead USB Printers  
**Original**  
**Price: ≤ \$8.35 / pc**



**ACC-LFP-128: Infiniti / Challenger Sync 400 Belt**  
Used for All Infiniti / Challenger Seiko Printhead USB Printers  
**Original**  
**Price: ≤ \$8.35 / pc**



**ACC-LFP-129: Infiniti / Challenger Sync Long Belt**  
Used for Infiniti / Challenger All Infiniti / Challenger Seiko Printhead USB Printers  
**Original**  
**Price: ≤ \$76.79 / pc**



**ACC-LFP-130: Infiniti / Challenger Negative Pressure Tank**  
Used for Infiniti / Challenger FY-3208HF / 3206HF  
**Original**  
**Price: ≤ \$245.41 / pc**



**ACC-LFP-131: Infiniti / Challenger Seiko Head Printer 14pin Date Cable**  
Used for All Infiniti / Challenger Seiko Printhead USB Printers  
**Original**  
**Price: ≤ \$11.69 / pc**



**ACC-LFP-132: Infiniti / Challenger Seiko Head Printer 16pin Date Cable**  
Used for All Infiniti / Challenger Seiko Printhead USB Printers  
**Original**  
**Price: ≤ \$11.69 / pc**



**ACC-LFP-133: Infiniti / Challenger Seiko Head Printer 18pin Date Cable**  
Used for All Infiniti / Challenger Seiko Printhead USB Printers  
**Original**  
**Price: ≤ \$11.69 / pc**



**ACC-LFP-134: Infiniti / Challenger Feeding & Take Up Sensor**  
Used for All Infiniti / Challenger Seiko Printhead USB Printers  
**Original**  
**Price: ≤ \$86.81 / pc**



**ACC-LFP-135: Infiniti / Challenger Sub Ink Tank (6 Colors)**  
Used for Infiniti / Challenger 6 heads USB Printers  
**Original**  
**Price: ≤ \$25.04 / pc**



**ACC-LFP-136: Infiniti / Challenger Air Tank (6 Colors)**  
Used for All Infiniti / Challenger USB 6 heads Printers  
**Original**  
**Price: ≤ \$26.71 / pc**



**ACC-LFP-137: Infiniti / Challenger Sub Ink Tank (4 Colors)**  
Used for Infiniti / Challenger USB 8 heads Printers  
**Original**  
**Price: ≤ \$22.54 / pc**



**ACC-LFP-138: Infiniti / Challenger Air Tank (4 Colors)**  
Used for Infiniti / Challenger USB 8 heads Printers  
**Original**  
**Price: ≤ \$26.71 / pc**



**ACC-LFP-139: Infiniti / Challenger Cleaning Panel Board (6 Colors)**  
Used for Infiniti / Challenger USB 6 heads Printers  
**Original**  
**Price: ≤ \$76.79 / pc**



**ACC-LFP-140: Infiniti / Challenger Cleaning Panel Board (4 Colors)**  
Used for Infiniti / Challenger USB 8 heads Printers  
**Original**  
**Price: ≤ \$75.13 / pc**



**ACC-LFP-141: Infiniti / Challenger New Cleaning Panel Board (6 Colors)**  
Used for Infiniti / Challenger USB 6 heads Printers  
**Original**  
**Price: ≤ \$75.13 / pc**

## &gt; Printer Spare Parts &gt; Myjet / Galaxy printer spare parts



**ACC-LFP-003: Measuring Pump for Myjet / YSL Printers**  
Used for Myjet, YSL inkjet printer, ect.  
**Original**  
**Price: ≤ \$42.07 / pc**



**ACC-LFP-081: Myjet 3216 Printer Carriage Board**  
Used for Myjet128 Printer  
**Original**  
**Price: ≤ \$500.00 / pc**



**ACC-LFP-082: Myjet Printer 128 2nd Servo Board**  
Used for Myjet128 Printer  
**Original**  
**Price: ≤ \$313.00 / pc**



**ACC-LFP-083: Myjet Printer 128 2nd PCI Card**  
Used for Myjet128 Printer  
**Original**  
**Price: ≤ \$634.00 / pc**



**ACC-LFP-084: Myjet Printer DB810 Motor Driver**  
Used for Myjet128 Printer, Myjet Xaar proton and Konica Printer  
**Original**  
**Price: ≤ \$103.51 / pc**



**ACC-LFP-084-01: Myjet Printer DCS810 Motor Driver**  
Used for Myjet128 Printer, Myjet Xaar proton and Konica Printer  
**Original**  
**Price: ≤ \$110.18 / pc**



**ACC-LFP-085: Myjet Printer Servo motor**  
Used for Myjet128 Printer  
**Original**  
**Price: ≤ \$125.21 / pc**



**ACC-LFP-086: Myjet Printer Xaar Drive Pulley**  
Used for Myjet128 Printer  
**Original**  
**Price: ≤ \$30.00 / pc**



**ACC-LFP-087: Myjet Printer Xaar Strain Pulley**  
Used for Myjet128 Printer  
**Original**  
**Price: ≤ \$29.22 / pc**



**ACC-LFP-088: Myjet Printer 494 Belt**  
Used for Myjet128 Printer, Myjet Xaar proton and Konica Printer  
**Original**  
**Price: ≤ \$10.02 / pc**



**ACC-LFP-089: Myjet Printer 320 Belt**  
Used for Myjet128 Printer, Myjet Xaar proton and Konica Printer  
**Original**  
**Price: ≤ \$10.02 / pc**



**ACC-LFP-090: Myjet Printer Encode Sensor**  
Used for Myjet128 Printer, Myjet Xaar proton and Konica Printer  
**Original**  
**Price: ≤ \$15.03 / pc**



**ACC-LFP-091: Myjet Printer Encoder Strip**  
Used for Myjet128 Printer, Myjet Xaar proton and Konica Printer  
**Original**  
**Price: ≤ \$15.03 / pc**



**ACC-LFP-092: Myjet Printer DC24V Relay**  
Used for Myjet128 Printer, Myjet Xaar proton and Konica Printer  
**Original**  
**Price: ≤ \$6.68 / pc**



**ACC-LFP-093: Myjet Printer Media Sensor**  
Used for Myjet128 Printer, Myjet Xaar proton and Konica Printer  
**Original**  
**Price: ≤ \$23.87 / pc**



**ACC-LFP-094: Myjet Printer Photo Electricity Sensor**  
Used for Myjet128 Printer, Myjet Xaar proton and Konica Printer  
**Original**  
**Price: ≤ \$21.70 / pc**



**ACC-LFP-096: Myjet Printer Switch (Red)**  
Used for Myjet128 Printer, Myjet Xaar proton and Konica Printer  
**Original**  
**Price: ≤ \$11.69 / pc**



**ACC-LFP-099: Myjet Printer Limited Switch**  
Used for Myjet128 Printer, Myjet Xaar proton and Konica Printer  
**Original**  
**Price: ≤ \$4.17 / pc**



**ACC-LFP-101: Myjet Printer Temperature Controller Display Board**  
Used for Myjet128 Printer, Myjet Xaar proton and Konica Printer  
**Original**  
**Price: ≤ \$35.06 / pc**



**ACC-LFP-102: Myjet Printer Print Heads Interface Board (128 2nd)**  
Used for Myjet128 Printer  
**Original**  
**Price: ≤ \$6.84 / pc**



**ACC-LFP-142: Galaxy Printer UD-181 / 1812LA Main Board**  
Used for Galaxy UD-181LA / UD-1812LA / UD-211LA / UD-251LA / UD-2112LA / UD-2512LA Printer  
**Original**  
**Price: ≤ \$517.00 / pc**



**ACC-LFP-143: Galaxy Printer UD-181 / 1812LA Printhead Board**  
Used for Galaxy UD-181LA / UD-1812LA / UD-211LA / UD-251LA / UD-2112LA / UD-2512LA Printer  
**Original**  
**Price: ≤ \$409.00 / pc**



**ACC-LFP-145: Galaxy Printer UD-181 / 1812LA Encoder Sensor**  
Used for Galaxy UD-181LA / UD-1812LA / UD-211LA / UD-251LA / UD-2112LA / UD-2512LA Printer  
**Original**  
**Price: ≤ \$25.88 / pc**



**ACC-LFP-146: Galaxy Printer UD-181/1812LA Encoder Strip**  
Used for Galaxy UD-181LA / UD-1812LA / UD-211LA / UD-251LA / UD-2112LA / UD-2512LA Printer  
**Original**  
**Price: ≤ \$21.70 / pc**



**ACC-LFP-147: Galaxy Printer UD-181 / 1812LA Cap Top**  
Used for Galaxy UD-181LA / UD-1812LA / UD-211LA / UD-251LA / UD-2112LA / UD-2512LA Printer  
**Original**  
**Price: ≤ \$35.06 / pc**



**ACC-LFP-148: Galaxy Printer UD-181 / 1812LA Optical Fiber**  
Used for Galaxy UD-181LA / UD-1812LA / UD-211LA / UD-251LA / UD-2112LA / UD-2512LA Printer  
**Original**  
**Price: ≤ \$9.18 / pc**



**ACC-LFP-149: Galaxy Printer UD-181 / 1812LA Printhead Cable**  
Used for Galaxy UD-181LA / UD-1812LA / UD-211LA / UD-251LA / UD-2112LA / UD-2512LA Printer  
**Original**  
**Price: ≤ \$2.67 / pc**



**ACC-LFP-154: Galaxy Printer UD-181/1812LA Ink Pump**  
Used for Galaxy UD-181LA / UD-1812LA / UD-211LA / UD-251LA / UD-2112LA / UD-2512LA Printer  
**Original**  
**Price: ≤ \$9.18 / pc**

## &gt; Printer Spare Parts &gt; Wit - color printer spare parts



ACC-WIT-26: WIT - COLOR 3312 / 3308 Printer 26Pin Date Cable  
Used for Wit - color 3312 / 3308 Printer  
**Original**  
**Price: ≤ \$20.00 / pc**



ACC-WIT-DC5V-1: WIT - COLOR 3312 / 3308 Printer Power Supply DC5V  
Used for Wit - color 3312 / 3308 Printer  
**Original**  
**Price: ≤ \$45.08 / pc**



ACC-WIT-DC24V-1: WIT - COLOR 3312 / 3308 Printer Power Supply  
Used for Wit - color 3312 / 3308 Printer  
**Original**  
**Price: ≤ \$45.08 / pc**



ACC-WIT-DCF-SV-1: WIT - COLOR 3312 / 3308 Printer Solenoid Valve  
Used for Wit - color 3312 / 3308 Printer  
**Original**  
**Price: ≤ \$11.35 / pc**



ACC-WIT-Dri-2280-A: WIT - COLOR 3312 / 3308 Printer Motor Driver  
Used for Wit - color 3312 / 3308 Printer  
**Original**  
**Price: ≤ \$484.00 / pc**



ACC-WIT-DZB-720A-1: WIT - COLOR 3312 / 3308 Printer Terminal Board  
Used for Wit - color 3312 / 3308 Printer  
**Original**  
**Price: ≤ \$180.30 / pc**



ACC-WIT-GMB-200A-1: WIT - COLOR 3312 / 3308 Printer Controller Board Ink Supply  
Used for Wit - color 3312 / 3308 Printer  
**Original**  
**Price: ≤ \$631.00 / pc**



ACC-WIT-GMB-720A-2: WIT - COLOR 3312 Printer Controller Board Ink Supply  
Used for Wit - color 3312 printer  
**Original**  
**Price: ≤ \$631.00 / pc**



ACC-WIT-M556-1: WIT - COLOR 3312 / 3308 Printer M556 Motor Driver  
Used for Wit - color 3312 / 3308 Printer  
**Original**  
**Price: ≤ \$211.15 / pc**



ACC-WIT-PTB-200A-1: WIT - COLOR 3308 Printer Carriage Terminal Control Board  
Used for Wit - color 3308 Printer  
**Original**  
**Price: ≤ \$191.65 / pc**



ACC-WIT-PTB-200B-1: WIT - COLOR 3312 Printer Carriage Terminal Control Board  
Used for Wit - color 3312 printer  
**Original**  
**Price: ≤ \$191.65 / pc**



ACC-WIT-PTB-720A-3: WIT - COLOR 720 Carriage Board  
Used for Wit - color 720 printer  
**Original**  
**Price: ≤ \$676.00 / pc**



ACC-WIT-XDB25-OAB-1: WIT - COLOR 3312 / 3308 Printer Optical Adapter Board  
Used for Wit - color 3312 / 3308 Printer  
**Original**  
**Price: ≤ \$33.39 / pc**



ACC-WIT-016: WIT - COLOR Ultra1000 Printer 26Pin Date Cable  
Used for Wit - color Ultra1000 / Ultra2000 / Ultra3000 Printer  
**Original**  
**Price: ≤ \$23.87 / pc**



ACC-WIT-017: WIT - COLOR Ultra1000 Printer Power Cable  
Used for Wit - color Ultra1000 / Ultra2000 / Ultra3000 Printer  
**Original**  
**Price: ≤ \$26.04 / pc**



ACC-WIT-018: WIT - COLOR Ultra1000 Printer 22Pin Ink Supply Cable  
Used for Wit - color Ultra1000 / Ultra2000 / Ultra3000 Printer  
**Original**  
**Price: ≤ \$22.54 / pc**



ACC-WIT-019: WIT - COLOR Ultra1000 Printer 16Pin High Voltage Cable  
Used for Wit - color Ultra1000 Printer  
**Original**  
**Price: ≤ \$26.04 / pc**



ACC-WIT-020: WIT - COLOR Ultra1000 Printer Carriage Control Board  
Used for Wit - color Ultra1000 Printer  
**Original**  
**Price: ≤ \$631.00 / pc**



ACC-WIT-021: WIT - COLOR Ultra1000 Printer High Voltage Switch Board  
Used for Wit - color Ultra1000 Printer  
**Original**  
**Price: ≤ \$788.00 / pc**



ACC-WIT-022: WIT - COLOR Ultra1000 Printer Terminal Board  
Used for Wit - color Ultra1000 Printer  
**Original**  
**Price: ≤ \$191.65 / pc**



ACC-WIT-023: WIT - COLOR Ultra2000 Printer Carriage Control Board  
Used for Wit - color Ultra2000 / Ultra3000 Printer  
**Original**  
**Price: ≤ \$631.00 / pc**



ACC-WIT-024: WIT - COLOR Ultra2000 Printer PCI Pixel Board  
Used for Wit - color Ultra2000 / Ultra3000 Printer  
**Original**  
**Price: ≤ \$2,817 / pc**



ACC-WIT-025: WIT - COLOR Ultra1000 Printer Ink Supply Board  
Used for Wit - color Ultra1000 / Ultra2000 / Ultra3000 Printer  
**Original**  
**Price: ≤ \$495.00 / pc**



ACC-WIT-026: WIT - COLOR Xaar382 Head Cable  
Used for Wit - color Ultra2000 / Ultra3000 Printer  
**Original**  
**Price: ≤ \$4.17 / pc**



ACC-WIT-027: WIT - COLOR Xaar382 Printhead Connector  
Used for Wit - color Ultra2000 / Ultra3000 Printer  
**Original**  
**Price: ≤ \$6.68 / pc**



ACC-WIT-028: WIT - COLOR Ultra2000 Printer Encoder Sensor  
Used for Wit - color Ultra2000 / Ultra3000 Printer  
**Original**  
**Price: ≤ \$63.11 / pc**



ACC-WIT-029: WIT - COLOR SCSI Date Cable  
Used for Wit - color Ultra1000 / Ultra2000 / Ultra3000 Printer  
**Original**  
**Price: ≤ \$41.74 / pc**

## &gt; Printer Spare Parts &gt; Flora printer spare parts



**ACC-FLO-001: Flora LJ320P Printer Servo Board**  
Used for Flora LJ320P Printer  
**Original**  
**Price: ≤ \$692 / pc**



**ACC-FLO-002: Flora LJ320K Printer Servo Board**  
Used for Flora LJ320K Printer  
**Original**  
**Price: ≤ \$692 / pc**



**ACC-FLO-003: Flora LJ320K Printer Printhead Board**  
Used for Flora LJ320K Printer  
**Original**  
**Price: ≤ \$1,235 / pc**



**ACC-FLO-004: Flora Motion Control Board**  
Used for Flora F180 Printer  
**Original**  
**Price: ≤ \$834 / pc**



**ACC-FLO-005: Flora LJ320P Printer USB Board**  
Used for Flora LJ320P Printer  
**Original**  
**Price: ≤ \$1,051 / pc**



**ACC-FLO-006: Flora LJ320P Printer High Voltage Switch Board**  
Used for Flora LJ320P Printer  
**Original**  
**Price: ≤ \$951 / pc**



**ACC-FLO-007: Flora LJ320P Printer 4 Heads Printhead Board**  
Used for Flora LJ320P Printer  
**Original**  
**Price: ≤ \$1,051 / pc**



**ACC-FLO-008: Flora LJ320P Printer 8 Heads Printhead Board**  
Used for Flora LJ320P Printer  
**Original**  
**Price: ≤ \$1,235 / pc**



**ACC-FLO-009: Flora LJ320P Printer Take Up Motor**  
Used for Flora LJ320P Printer  
**Original**  
**Price: ≤ \$125.21 / pc**



**ACC-FLO-010: Flora LJ320P Printer DC24V Fan**  
Used for Flora LJ320P Printer  
**Original**  
**Price: ≤ \$33.39 / pc**



**ACC-FLO-011: Flora LJ320P Printer AC220V Fan**  
Used for Flora LJ320P Printer  
**Original**  
**Price: ≤ \$46.74 / pc**



**ACC-FLO-012: Flora LJ320P Printer Printhead Cable**  
Used for Flora LJ320P Printer  
**Original**  
**Price: ≤ \$26.71 / pc**



**ACC-FLO-013: Flora LJ320P Printer Printhead Filter**  
Used for Flora LJ320P Printer  
**Original**  
**Price: ≤ \$45.08 / pc**



**ACC-FLO-014: Flora LJ320P Printer High Voltage Cable**  
Used for Flora LJ320P Printer  
**Original**  
**Price: ≤ \$138.56 / pc**



**ACC-FLO-015: Flora LJ320P Printer Fiber - optical Date Cable**  
Used for Flora LJ320P Printer  
**Original**  
**Price: ≤ \$40.07 / pc**



**ACC-FLO-016: Flora LJ320P Printer Temperature Sensor**  
Used for Flora LJ320P Printer  
**Original**  
**Price: ≤ \$40.07 / pc**



**ACC-FLO-017: Flora LJ320P Printer Cleaning Switch**  
Used for Flora LJ320P Printer  
**Original**  
**Price: ≤ \$50.08 / pc**



**ACC-FLO-018: Flora LJ320P Printer Printhead Serial Port Cable**  
Used for Flora LJ320P Printer  
**Original**  
**Price: ≤ \$55.09 / pc**



**ACC-FLO-019: Flora LJ320P Printer High Voltage Signal Cable**  
Used for Flora LJ320P Printer  
**Original**  
**Price: ≤ \$55.09 / pc**



**ACC-FLO-020: Flora LJ320P Printer Pump Power Cable**  
Used for Flora LJ320P Printer  
**Original**  
**Price: ≤ \$73.46 / pc**



**ACC-FLO-021: Flora LJ320K Printer 36pin Transform 100pin Cable**  
Used for Flora LJ320K Printer  
**Original**  
**Price: ≤ \$200.33 / pc**



**ACC-FLO-022: Flora LJ320K Printer Level Sensors Cable**  
Used for Flora LJ320K Printer  
**Original**  
**Price: ≤ \$100.17 / pc**



**ACC-FLO-023: Flora LJ320K Printer DC Power Cable**  
Used for Flora LJ320K Printer  
**Original**  
**Price: ≤ \$83.47 / pc**



**ACC-FLO-024: Flora LJ320P Printer Printhead DC Power Cable**  
Used for Flora LJ320P Printer  
**Original**  
**Price: ≤ \$75.13 / pc**



**ACC-FLO-025: Flora LJ320P Printer Encoder Raster**  
Used for Flora LJ320P Printer  
**Original**  
**Price: ≤ \$58.43 / pc**



**ACC-FLO-026: Flora LJ320K Printer Encoder Raster A**  
Used for Flora LJ320K Printer  
**Original**  
**Price: ≤ \$55.09 / pc**



**ACC-FLO-027: Flora LJ320K Printer Encoder Raster B**  
Used for Flora LJ320K Printer  
**Original**  
**Price: ≤ \$55.09 / pc**



**ACC-FLO-028: Flora PP2512UV Printer Raster Sensor**  
Used for Flora PP2512UV Printer  
**Original**  
**Price: ≤ \$101.84 / pc**

## &gt; Printer Spare Parts &gt; Flora printer spare parts



**ACC-FLO-029: Flora LJ320K Printer Original Negative Pressure**  
Used for Flora LJ320K Printer  
**Original**  
**Price: ≤ \$51.75 / pc**



**ACC-FLO-030: Flora LJ320K Printer OEM Negative Pressure**  
Used for Flora LJ320K Printer  
**Original**  
**Price: ≤ \$27.55 / pc**



**ACC-FLO-031: Flora LJ320P Printer Raster Sensor Cable**  
Used for Flora LJ320P Printer  
**Original**  
**Price: ≤ \$58.43 / pc**



**ACC-FLO-032: Flora LJ320P Printer Bearing**  
Used for Flora LJ320P Printer  
**Original**  
**Price: ≤ \$106.84 / pc**



**ACC-FLO-033: Flora LJ320K Printer Printhead Cable**  
Used for Flora LJ320K Printer  
**Original**  
**Price: ≤ \$27.55 / pc**



**ACC-FLO-034: Flora LJ320P Printer Bearing**  
Used for Flora LJ320K Printer  
**Original**  
**Price: ≤ \$106.84 / pc**



**ACC-FLO-035: Flora LJ320P Printer Servo Motor Driver**  
Used for Flora LJ320P Printer  
**Original**  
**Price: ≤ \$191.99 / pc**



**ACC-FLO-036: Flora LJ320P Printer Servo Motor**  
Used for Flora LJ320P Printer  
**Original**  
**Price: ≤ \$175.29 / pc**



**ACC-FLO-037: Flora LJ320P Printer Double Pulley**  
Used for Flora LJ320P Printer  
**Original**  
**Price: ≤ \$166.94 / pc**



**ACC-FLO-038: Flora LJ320P Printer Vacuum Negative**  
Used for Flora LJ320P Printer  
**Original**  
**Price: ≤ \$158.6 / pc**



**ACC-FLO-039: Flora LJ320P Printer Motor Belt**  
Used for Flora LJ320P Printer  
**Original**  
**Price: ≤ \$40.07 / pc**



**ACC-FLO-040: Flora LJ320P / 320K Printer Big Pump**  
Used for Flora LJ320P / 320K Printer  
**Original**  
**Price: ≤ \$46.74 / pc**



**ACC-FLO-041: Flora LJ320 / 320K Printer Ink Filter**  
Used for Flora LJ320P / 320K Printer  
**Original**  
**Price: ≤ \$23.37 / pc**



**ACC-FLO-042: Flora LJ320P / 320K Printer Small Ink Pump**  
Used for Flora LJ320P / 320K Printer  
**Original**  
**Price: ≤ \$33.39 / pc**



**ACC-FLO-043: Flora UV Printer UV Ink Pump**  
Used for All Flora UV Printers  
**Original**  
**Price: ≤ \$191.99 / pc**



**ACC-FLO-044: Flora LJ320P Printer Four - way Valve**  
Used for Flora LJ320P Printer  
**Original**  
**Price: ≤ \$118.53 / pc**

> Accessional Device for Printer



### 64" Eco-Solvent Large Format Printer Dryer

- **Operating principle:** Drying the graphic with hot air.
- **Main function:** Drying the graphic.
- **Switch control:** Adjustable temperature, independent switch control in the tuyere, distinguishing the temperature with twinkle frequency.
- Apply to all water and ECO printers printing.



▼ Specifications

Model	Voltage	Power	Working Width	Price
ECO Printer Dryer	220V	3KW	1700mm (67")	≤ \$446 / set



### Mutoh VJ1604 Automatic Media Take - up Roller

- State of art take - up system with tension controlling, which not only extends motor's life, but also makes medium rolled more neatly.
- Applicable range is expanded at the same time, such as car sticker, textile cloth, paper, wallpaper, etc.
- The bearing weight is 40kg, apply to aqueous and light slovent printing.
- Apply to Mutoh VJ16 Series, Epson GS6000, Epson 7700 and Epson 9700. (Other models can be customized according to the demensions provided )

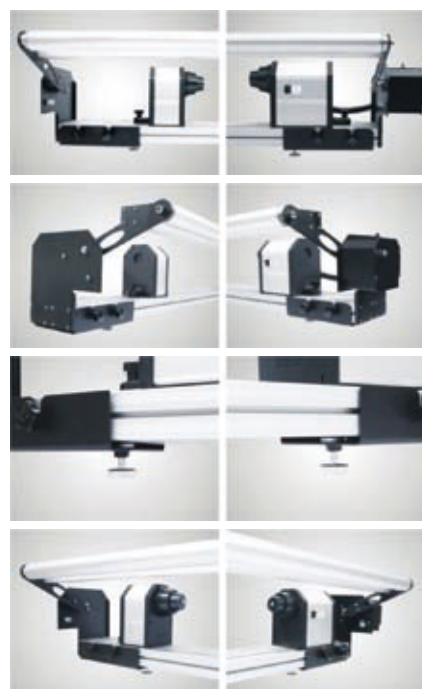

▼ Specifications

Model	PZS301	PZS302	PZS303	PZS304
Applied Printer	Mutoh VJ1604	Roland FJ740	Roland VP540	Epson 9700
Working Width	1600mm (63")	1800mm (71")	1300mm (51")	1300mm (51")
Voltage	12V	12V	12V	12V
Motor Power	24W	24W	24W	24W
Maximum Diameter of Hosting Media	260mm (10")	260mm (10")	260mm (10")	260mm (10")
Bearing Weight	40kg	40kg	40kg	40kg
<b>Price</b>	≤ \$637 / set	≤ \$637 / set	≤ \$637 / set	≤ \$637 / set



## &gt; Accessional Device for Printer

**Roland Automatic Media Take - up Roller**

- Operating principle: Motor drive.
- Main function: To tighten the paper.
- Adjustable Torque: It can be adjusted according to the different materials.
- Applied to Roland FJ740, Roland RS640, VP540 (Other models can be customized according to the demensions provided)

## ▼ Specifications

Model	PZS201	PZS202	PZS203	PZS204
Applied Printer	Roland FJ740	Roland RS640	Roland VP540	Epson 11880C
Working Width	1600mm (63")	1800mm (71")	1300mm (51")	1600mm (63")
Voltage	12V	12V	12V	12V
Motor Power	24W	24W	24W	24W
Maximum Diameter of Hosting Media	220mm (8.7")	220mm (8.7")	220mm (8.7")	220mm (8.7")
Bearing Weight	35kg	35kg	35kg	35kg
<b>Price</b>	≤ \$264 / set	≤ \$264 / set	≤ \$264 / set	≤ \$264 / set

**Inc-1200 Series Ink Vacuum**

It is specially designed for cleaning printer nozzle by vacuum absorbing function.

It is making up of ink absorbing motor in the top, filter in the middle and ink - storage in the bottom.

- Special designed exchangeable filter element, mounted between motor and waste ink tank, prevents motor from being polluted.
- Proof - corrode structure realizes a longer lifetime.
- Ink vacuum is used to avoid the inkjet printhead from being blocked and it will absorb the waste ink when the printhead is blocked.
- 1200 A type has smaller diameter, which is  $\Phi 275\text{mm}$  (11") & 450mm (17.7").



Inc-1200-A



Inc-1200-B

## ▼ Specifications

Model	Inc-1200-A	Inc-1200-B
Rated Voltage	220V, 50HZ / 60HZ	220V, 50Hz / 60Hz
Rated Power	1200W	1200W
Weight	10kg	10kg
Shape Size	550mm (21.6") H x 275mm (11") Diameter	550mm (21.6") H x 450mm (17.7") Diameter
Storage of Waste Ink	12L	12L
<b>Price</b>	≤ \$239 / set	≤ \$294 / set





## > Accessional Device for Printer

### PULSE JET NOZZLE WASHER

High - performance fully automatic nozzle washer is one of the main product focusing on the solution of nozzle blockage problems. It is useful complement to our Ultrasonic Ink Supplying Series Product. Whenever the nozzle gets blockage and thread oblique, this machine could be used for solve these problems. It is suitable for daily nozzle maintenance of the printing companies and professional nozzle service people as well.



#### ▼ Product Highlights

- IC controlling system keeps the whole working proceed running automatically, and the LCD panel indicate each step of the washing program.
- Ultrasonic and Pulse Jet flush working in the same time. So as to guarantee the dirt could be washed out immediately whenever the ultrasonic wave loosed it.
- Suitable for xaar126, xaar128, Konica Seiko 500 and others, which are the most popular printhead.
- Adjustable Ultrasonic running cycle up to 99 times.
- Adjustable soak time up to 99 minutes.
- Adjustable flush cycle up to 99 times.
- External Heating system, make your washing job safe and efficient.
- Automatic running program save your valuable time.

**Price:** ≤ \$1,101 / set

### Ultrasonic Ink Supplying Product

The ultrasonic series include: Ultrasonic Ink Supplier & Ultrasonic Ink Tank. They are composed by Ultrasonic wave emitter, electric heating system, digital temperature sensor, timer / scheduler, and heat tracking devices. Upon starting the ultrasonic system, ultrasonic radiation is automatically applied to the ink, allowing the ink to maintain its finest position by breaking apart pigment molecules clusters, creating cavitations and vacuum within the clusters. With the vibration inside the ink, it with the resulting effect of banishing all the common problems of clogging and uneven concentration and maintain the ink in its best possible state, until it used up. Also, our ultrasonic ink - supplying system, using the electrical heating method, enables printing to be done in winters with the same, fabulous effects.

#### The Amazing Effects of the Ultrasonic Ink Supplying System

- Protecting the printing - heads from blockages and thus extending its life.
- Stops clogging, clustering, or uneven concentration of pigment molecules in solvent.
- Prevents clogging, tearing, or instability of the ink when a printing job is underway.
- Using the ultrasonic splicing system, make the pigment molecules smaller, more refined, and thus creates more vivid images.
- Maintaining the temperature within the ink - tank in the best possible temperature range.



#### ▼ Specifications

Model	Power	Ultrasonic Wave Power	Heating System Power	Ink Temp	Quantity of Ink Tank	Volume of Ink Tank	Running Procedure	Price
UT3.5-4	AC220V<4A	200W	80W	Temp adjustable	4 tanks / set	3.5L x 4	Automatic / Running Procedure and ink temp adjustable	≤ \$990 / set
UT3.5	AC220V<1A	55W / unit	20W / unit	Fixed temp 28°C - 38°C	4 units / set	3.5L / Unit	Automatic / Ultrasonic 5min / suspend 60 min	≤ \$145 / unit
UL3.5	AC220V<1A	55W / unit	-	No thermostat	4 units / set	3.5L / Unit	Automatic / Ultrasonic 5min / suspend 60 min	≤ \$130 / unit
UT1.3	AC220V<1A	30W / unit	15W / unit	Fixed temp 28°C - 38°C	4 units / set	1.3L / Unit	Automatic / Ultrasonic 5min / suspend 60 min	≤ \$81 / unit
UL1.3	AC220V<1A	30W / unit	-	No thermostat	4 units / set	1.3L / Unit	Automatic / Ultrasonic 5min / suspend 60 min	≤ \$65 / unit

Effectively solve the problem of printhead blockage, magic ultrasonic ink supplier, presenting gorgeous image, 7 patented copy rights, solve printing difficult.

> Accessional Device for Printer

### Automatic Picture Drying and Take - up Device

Drying and collecting simultaneously.  
 Drying by Infrared - ray.  
 Regulating temperature.  
 The wind and temperature can be adjusted.

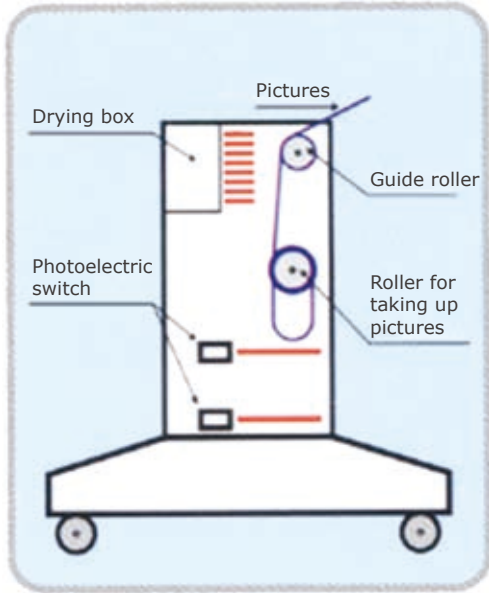

HGJ-1600-ST

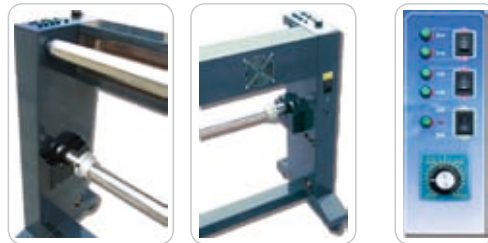

Solving the adhesive problems and matching with all kinds of indoor printer

▼ Specifications

Model	HGJ-940-ST	HGJ-1300-ST	HGJ-1600-ST	HGJ-2000-ST
Working Width	940mm (37")	1300mm (51")	1600mm (63")	2000mm (79")
Motor Power	10W	10W	10W	10W
Heating Power	800W	1200W	1500W	1600W
Machine Weight	88Ib (40kg)	99Ib (45kg)	105Ib (48kg)	127Ib (58kg)
Machine Dimensions	1100mm x 420mm x 760mm (43" x 16.5" x 30")	1590mm x 420mm x 760mm (63" x 16.5" x 30")	1890mm x 420mm x 760mm (74" x 16.5" x 30")	2290mm x 420mm x 760mm (90" x 16.5" x 30")
Price	≤ \$528 / set	≤ \$550 / set	≤ \$506 / set	≤ \$617 / set

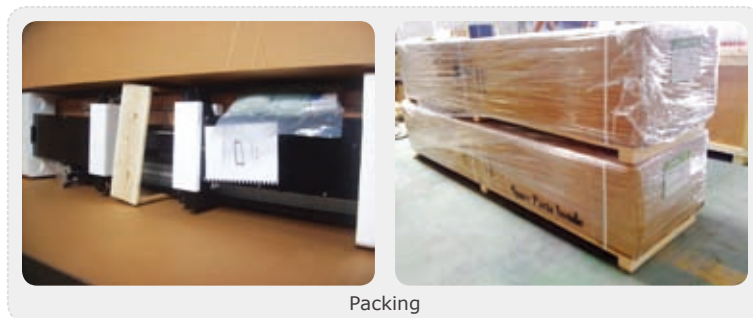

Packing



## PVC Inkjet Media

**Media Width:** 36" / 42" / 50" / 60" (0.914m / 1.07m / 1.27m / 1.52m)

**Media Length:** 30m per roll

**Suitable Inkjet Printers:** Mutoh, Roland, HP, Epson, Mimaki, Encad, etc.

**Suitable Inks:** Water-based ink, ECO ink, Pigment ink

**About Price:** The price of advertising material products list on this book is the third ladder price. You can visit our website [www.sign-in-china.com](http://www.sign-in-china.com) for reference.

## High quality PVC rigid film in 180µm

In the basis of high quality PVC rigid film in 180µm, good surface coating treatment, glossy, better ink suction and quick dry.

- Good stiffness and uncurling for a long time during display.
- To be printed as screen of X display and POP UP display.
- Meet for ECO, SOLVENT and UV ink.
- Matte surface.



### ▼ Specifications (Quotation according to sq. m)

Name	Series	Thickness	Price
Rigid PVC Sheet	BS-BC-180QG-NS	180µm	\$1.12 / sq. m
Rigid PVC Sheet	BS-BC-180QM-NS	180µm	\$1.12 / sq. m
Rigid PVC (Anti - static Coating)	BS-GBC-180QG-NS	180µm	\$1.26 / sq. m
Rigid PVC (Anti - static Coating)	BS-GBC-180QM-NS	180µm	\$1.26 / sq. m

### ▼ Specifications (Quotation according to roll)

Name	Series	Code	Width	Thickness	Length / roll	Price
Rigid PVC Sheet	BS-BC-180QG-NS	BS-BC-180QG-36R-NS	36" (0.914m)	180µm	30m	\$30.82 / roll
		BS-BC-180QG-42R-NS	42" (1.07m)	180µm	30m	\$36.08 / roll
		BS-BC-180QG-50R-NS	50" (1.27m)	180µm	30m	\$42.82 / roll
		BS-BC-180QG-60R-NS	60" (1.52m)	180µm	30m	\$51.26 / roll
Rigid PVC Sheet	BS-BC-180QM-NS	BS-BC-180QM-36R-NS	36" (0.914m)	180µm	30m	\$30.82 / roll
		BS-BC-180QM-42R-NS	42" (1.07m)	180µm	30m	\$36.08 / roll
		BS-BC-180QM-50R-NS	50" (1.27m)	180µm	30m	\$42.82 / roll
		BS-BC-180QM-60R-NS	60" (1.52m)	180µm	30m	\$51.26 / roll
Rigid PVC (Anti - static Coating)	BS-GBC-180QG-NS	BS-GBC-180QG-36R-NS	36" (0.914m)	180µm	30m	\$34.67 / roll
		BS-GBC-180QG-42R-NS	42" (1.07m)	180µm	30m	\$40.60 / roll
		BS-GBC-180QG-50R-NS	50" (1.27m)	180µm	30m	\$48.19 / roll
Rigid PVC (Anti - static Coating)	BS-GBC-180QM-NS	BS-GBC-180QM-36R-NS	36" (0.914m)	180µm	30m	\$34.67 / roll
		BS-GBC-180QM-42R-NS	42" (1.07m)	180µm	30m	\$40.60 / roll
		BS-GBC-180QM-50R-NS	50" (1.27m)	180µm	30m	\$48.19 / roll

## High quality PVC film in 100µm

In the basis of high - quality PVC film in 100µm, silver glue and wood pulp backing paper. Especially used for unclear car body and rear panel.

- Unique embossed backing paper, tiny lines on the backing paper, bubble free during sticking.
- To be widely used for advertising in bus, subway, and so on.
- Meet for ECO, Solvent and UV ink.
- To be used for outdoor more than 2 years.



### ▼ Specifications (Quotation according to sq. m)

Name	Series	Thickness	Price
EUROPEL PVC Vinyl (Bubble free)	BS-GBC-100WGP-NS	100µm	\$1.69 / sq. m
EUROPEL Grey Adhesive Vinyl (Bubble free)	BS-GBC-100WGBP-NS	100µm	\$1.97 / sq. m
Professional PVC Vinyl	BS-BC-100WGP-NS	100µm	\$1.26 / sq. m
Professional PVC Vinyl with Grey Adhesive	BS-BC-100WGBP-NS	100µm	\$1.55 / sq. m

## ▼ Specifications (Quotation according to roll)

Name	Series	Code	Width	Thickness	Length / roll	Price
EUROPEL PVC Vinyl (Bubble free)	BS-GBC-100WGP-NS	BS-GBC-100WGP-36R-NS	36" (0.914m)	100µm	30m	\$46.23 / roll
		BS-GBC-100WGP-42R-NS	42" (1.07m)	100µm	30m	\$54.12 / roll
		BS-GBC-100WGP-50R-NS	50" (1.27m)	100µm	30m	\$64.23 / roll
		BS-GBC-100WGP-60R-NS	60" (1.52m)	100µm	30m	\$76.88 / roll
EUROPEL Grey Adhesive Vinyl (Bubble free)	BS-GBC-100WGBP-NS	BS-GBC-100WGBP-36R-NS	36" (0.914m)	100µm	30m	\$53.93 / roll
		BS-GBC-100WGBP-42R-NS	42" (1.07m)	100µm	30m	\$63.14 / roll
		BS-GBC-100WGBP-50R-NS	50" (1.27m)	100µm	30m	\$74.94 / roll
		BS-GBC-100WGBP-60R-NS	60" (1.52m)	100µm	30m	\$89.69 / roll
Professional PVC Vinyl	BS-BC-100WGP-NS	BS-BC-100WGP-36R-NS	36" (0.914m)	100µm	30m	\$34.67 / roll
		BS-BC-100WGP-42R-NS	42" (1.07m)	100µm	30m	\$40.60 / roll
		BS-BC-100WGP-50R-NS	50" (1.27m)	100µm	30m	\$48.19 / roll
		BS-BC-100WGP-60R-NS	60" (1.52m)	100µm	30m	\$57.67 / roll
Professional PVC Vinyl with Grey Adhesive	BS-BC-100WGBP-NS	BS-BC-100WGBP-36R-NS	36" (0.914m)	100µm	30m	\$42.37 / roll
		BS-BC-100WGBP-42R-NS	42" (1.07m)	100µm	30m	\$49.61 / roll
		BS-BC-100WGBP-50R-NS	50" (1.27m)	100µm	30m	\$58.88 / roll
		BS-BC-100WGBP-60R-NS	60" (1.52m)	100µm	30m	\$70.47 / roll

## Cold laminating film

We can provide 16 kinds of cold laminating film which is especially used in studio. Any surface treatment is different. We get more personalized choices for person, families and studios.

- The surfaces are foggy style, frosted glass, cross texture, coarse cross texture, coarse frosted glass and cover leather.
- You could choose your favorite good according to your own idea.

## ▼ Specifications (Quotation according to sq. m)

Name	Series	Thickness	Price
Top Cold Laminating Film (Leather textile surface for Ad.)	BS-BC-100CM-NS	100µm	\$1.26 / sq. m
Top Cold Laminating Film (Fine frosted surface for Ad.)	BS-BC-100BM-NS	100µm	\$1.26 / sq. m
Top Cold Laminating Film (Matte surface for Ad.)	BS-BC-100AM-NS	100µm	\$1.26 / sq. m
Top Cold Laminating Film (Glossy surface for Ad.)	BS-BC-100AG-NS	100µm	\$1.26 / sq. m
Top Cold laminating Film (No. #4 - #9 for photo - studio)	BS-LAM-4-9#-NS	100µm	\$1.40 / sq. m
Top Cold laminating Film (No. #2 - #16 for photo - studio)	BS-LAM-2-16#-36R-NS	100µm	\$2.11 / sq. m
Top Cold laminating Film (Glossy surface for photo - studio)	BS-LAM-1#-NS	100µm	\$1.46 / sq. m

## ▼ Specifications (Quotation according to roll)

Name	Series	Code	Width	Thickness	Length / roll	Price
Top Cold Laminating Film (Leather textile surface for Ad.)	BS-BC-100CM-NS	BS-BC-100CM-36R-NS	36" (0.914m)	100µm	30m	\$34.67 / roll
		BS-BC-100CM-42R-NS	42" (1.07m)	100µm	30m	\$40.60 / roll
		BS-BC-100CM-50R-NS	50" (1.27m)	100µm	30m	\$48.19 / roll
		BS-BC-100CM-60R-NS	60" (1.52m)	100µm	30m	\$57.67 / roll
Top Cold Laminating Film (Fine frosted surface for Ad.)	BS-BC-100BM-NS	BS-BC-100BM-36R-NS	36" (0.914m)	100µm	30m	\$34.67 / roll
		BS-BC-100BM-42R-NS	42" (1.07m)	100µm	30m	\$40.60 / roll
		BS-BC-100BM-50R-NS	50" (1.27m)	100µm	30m	\$48.19 / roll
		BS-BC-100BM-60R-NS	60" (1.52m)	100µm	30m	\$57.67 / roll
Top Cold Laminating Film (Matte surface for Ad.)	BS-BC-100AM-NS	BS-BC-100AM-36R-NS	36" (0.914m)	100µm	30m	\$34.67 / roll
		BS-BC-100AM-42R-NS	42" (1.07m)	100µm	30m	\$40.60 / roll
		BS-BC-100AM-50R-NS	50" (1.27m)	100µm	30m	\$48.19 / roll
		BS-BC-100AM-60R-NS	60" (1.52m)	100µm	30m	\$57.67 / roll
Top Cold Laminating Film (Glossy surface for Ad.)	BS-BC-100AG-NS	BS-BC-100AG-36R-NS	36" (0.914m)	100µm	30m	\$34.67 / roll
		BS-BC-100AG-42R-NS	42" (1.07m)	100µm	30m	\$40.60 / roll
		BS-BC-100AG-50R-NS	50" (1.27m)	100µm	30m	\$48.19 / roll
		BS-BC-100AG-60R-NS	60" (1.52m)	100µm	30m	\$57.67 / roll
Top Cold-laminating Film (No. #4 - #9 for photo - studio)	BS-LAM-4-9#-NS	BS-LAM-4-9#-36R-NS	36" (0.914m)	100µm	30m	\$38.52 / roll
		BS-LAM-4-9#-42R-NS	42" (1.07m)	100µm	30m	\$45.10 / roll
		BS-LAM-4-9#-50R-NS	50" (1.27m)	100µm	30m	\$53.53 / roll
		BS-LAM-4-9#-60R-NS	60" (1.52m)	100µm	30m	\$64.06 / roll
Top Cold laminating Film (No. #2 - #16 for photo - studio)	BS-LAM-2-16#-36R-NS	BS-LAM-2-16#-36R-NS	36" (0.914m)	100µm	30m	\$57.78 / roll
		BS-LAM-2-16#-42R-NS	42" (1.07m)	100µm	30m	\$67.65 / roll
		BS-LAM-2-16#-50R-NS	50" (1.27m)	100µm	30m	\$80.29 / roll
		BS-LAM-2-16#-60R-NS	60" (1.52m)	100µm	30m	\$96.10 / roll
Top Cold laminating Film (Glossy surface for photo - studio)	BS-LAM-1#-NS	BS-LAM-1#-36R-NS	36" (0.914m)	100µm	30m	\$57.78 / roll
		BS-LAM-1#-42R-NS	42" (1.07m)	100µm	30m	\$67.65 / roll
		BS-LAM-1#-50R-NS	50" (1.27m)	100µm	30m	\$80.29 / roll
		BS-LAM-1#-60R-NS	60" (1.52m)	100µm	30m	\$96.10 / roll

## Glossy RC Water - proof Media

"RC" means this item is laminated with PE on both sides, compared with common photo paper it has better waterproofing ability. It is not easy deformed and convenient to store, thus more suitable for Maritime Provinces.

- As the surface coating has been treated for waterproofing, it is suitable for outdoor using.
- Mainly used for Roll up banner, X banner stand and poster.
- Self-adhesive, suitable to be slicked on the back boards, walls, shop windows, etc.

**Media Width:** 24" / 36" / 42" / 50" / 60" (0.61m / 0.914m / 1.07m / 1.27m / 1.52m)

**Media Length:** 25m, 30m per roll

**Suitable Inkjet Printers:** Mutoh, Roland, HP, Epson, Mimaki, Encad, etc.

**Suitable Inks:** Water-based ink, ECO ink, Pigment ink, dye

**About Price:** The price of advertising material products list on this book is the third ladder price.

You can visit our website [www.sign-in-china.com](http://www.sign-in-china.com) for reference.

### ▼ Samples

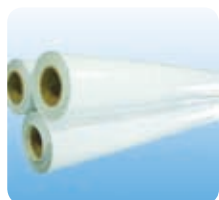

Glossy W / P PP Film



Glossy W / P PP with Self adhesive



Glossy W / P PVC with Self adhesive

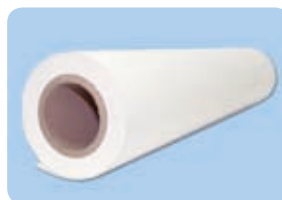

RC Silk W / P Photo Paper



RC Velvet W / P Photo paper

### ▼ Specifications (Quotation according to sq. m)

Name	Series	Weight	Length / roll	Width	Price
RC Glossy W / P Photo Paper	BS-PH-180GN-NS	180gsm	25m	24" / 36" / 42" / 50" / 60" (0.61m / 0.914m / 1.07m / 1.27m / 1.52m)	\$1.55 / sq. m
	BS-PH-230GN-NS	230gsm	25m	24" / 36" / 42" / 50" / 60" (0.61m / 0.914m / 1.07m / 1.27m / 1.52m)	\$1.83 / sq. m
	BS-PH-260GN-NS	260gsm	25m	24" / 36" / 42" / 50" / 60" (0.61m / 0.914m / 1.07m / 1.27m / 1.52m)	\$1.97 / sq. m
RC Silky W / P Photo Paper	BS-PH-180SN-NS	180gsm	25m	24" / 36" / 42" / 50" / 60" (0.61m / 0.914m / 1.07m / 1.27m / 1.52m)	\$1.55 / sq. m
	BS-PH-230SN-NS	230gsm	25m	24" / 36" / 42" / 50" / 60" (0.61m / 0.914m / 1.07m / 1.27m / 1.52m)	\$1.83 / sq. m
	BS-PH-260SN-NS	260gsm	25m	24" / 36" / 42" / 50" / 60" (0.61m / 0.914m / 1.07m / 1.27m / 1.52m)	\$1.97 / sq. m
RC Velvet W / P Photo Paper	BS-PH-180NS-NS	180gsm	25m	24" / 36" / 42" / 50" / 60" (0.61m / 0.914m / 1.07m / 1.27m / 1.52m)	\$1.55 / sq. m
	BS-PH-230NS-NS	230gsm	25m	24" / 36" / 42" / 50" / 60" (0.61m / 0.914m / 1.07m / 1.27m / 1.52m)	\$1.83 / sq. m
	BS-PH-260NS-NS	260gsm	25m	24" / 36" / 42" / 50" / 60" (0.61m / 0.914m / 1.07m / 1.27m / 1.52m)	\$1.97 / sq. m
Glossy W / P Photo Paper S / A	BS-PH-180GNL-NS	180gsm	25m	24" / 36" / 42" / 50" / 60" (0.61m / 0.914m / 1.07m / 1.27m / 1.52m)	\$1.97 / sq. m
	BS-PH-220GNL-NS	220gsm	25m	24" / 36" / 42" / 50" / 60" (0.61m / 0.914m / 1.07m / 1.27m / 1.52m)	\$2.11 / sq. m
	BS-PH-260GNL-NS	260gsm	25m	24" / 36" / 42" / 50" / 60" (0.61m / 0.914m / 1.07m / 1.27m / 1.52m)	\$2.25 / sq. m

Name	Series	Thickness	Length / roll	Width	Price
Glossy W / P Front Print acklit Film	BS-TF-100GN-NS	100µm	30m	36" / 42" / 50" / 60" (0.914m / 1.07m / 1.27m / 1.52m)	\$1.97 / sq. m
	BS-TF-200GN-NS	200µm	30m	36" / 42" / 50" / 60" (0.914m / 1.07m / 1.27m / 1.52m)	\$2.81 / sq. m
Glossy W / P PP with Self-adhesive	BS-120GNL-NS	120µm	30m	36" / 42" / 50" / 60" (0.914m / 1.07m / 1.27m / 1.52m)	\$1.97 / sq. m
	BS-150GNL-NS	150µm	30m	36" / 42" / 50" / 60" (0.914m / 1.07m / 1.27m / 1.52m)	\$2.11 / sq. m
Glossy W / P PP Film	BS-150GN-NS	150µm	30m	36" / 42" / 50" / 60" (0.914m / 1.07m / 1.27m / 1.52m)	\$1.40 / sq. m
	BS-180GN-NS	180µm	30m	36" / 42" / 50" / 60" (0.914m / 1.07m / 1.27m / 1.52m)	\$1.55 / sq. m
Glossy W / P PVC with Self - adhesive	BS-BC-100GNP-NS	100µm	30m	36" / 42" / 50" / 60" (0.914m / 1.07m / 1.27m / 1.52m)	\$2.67 / sq. m

## &gt; Materials and Inks &gt; Indoor inkjet media &gt; glossy RC water - proof media

## ▼ Specifications (Quotation according to roll)

Name	Series	Code	Width / roll	Weight	Length	Price
RC Glossy W / P Photo Paper	BS-PH-180GN-NS	BS-PH-180GN-17R-NS	17" (0.43m)	180gsm	25m	\$16.62 / roll
		BS-PH-180GN-24R-NS	24" (0.61m)	180gsm	25m	\$23.57 / roll
		BS-PH-180GN-36R-NS	36" (0.914m)	180gsm	25m	\$35.32 / roll
		BS-PH-180GN-42R-NS	42" (1.07m)	180gsm	25m	\$41.34 / roll
		BS-PH-180GN-50R-NS	50" (1.27m)	180gsm	25m	\$49.07 / roll
		BS-PH-180GN-60R-NS	60" (1.52m)	180gsm	25m	\$58.73 / roll
RC Glossy W / P Photo Paper	BS-PH-230GN-NS	BS-PH-230GN-17R-NS	17" (0.43m)	230gsm	25m	\$19.64 / roll
		BS-PH-230GN-24R-NS	24" (0.61m)	230gsm	25m	\$27.85 / roll
		BS-PH-230GN-36R-NS	36" (0.914m)	230gsm	25m	\$41.74 / roll
		BS-PH-230GN-42R-NS	42" (1.07m)	230gsm	25m	\$48.86 / roll
		BS-PH-230GN-50R-NS	50" (1.27m)	230gsm	25m	\$57.99 / roll
		BS-PH-230GN-60R-NS	60" (1.52m)	230gsm	25m	\$69.40 / roll
RC Glossy W / P Photo Paper	BS-PH-260GN-NS	BS-PH-260GN-17R-NS	17" (0.43m)	260gsm	25m	\$21.15 / roll
		BS-PH-260GN-24R-NS	24" (0.61m)	260gsm	25m	\$30.0 / roll
		BS-PH-260GN-36R-NS	36" (0.914m)	260gsm	25m	\$44.95 / roll
		BS-PH-260GN-42R-NS	42" (1.07m)	260gsm	25m	\$52.62 / roll
		BS-PH-260GN-50R-NS	50" (1.27m)	260gsm	25m	\$62.45 / roll
		BS-PH-260GN-60R-NS	60" (1.52m)	260gsm	25m	\$74.74 / roll
RC Silky W / P Photo Paper	BS-PH-180SN-NS	BS-PH-180SN-17R-NS	17" (0.43m)	180gsm	25m	\$16.62 / roll
		BS-PH-180SN-24R-NS	24" (0.61m)	180gsm	25m	\$23.57 / roll
		BS-PH-180SN-36R-NS	36" (0.914m)	180gsm	25m	\$35.32 / roll
		BS-PH-180SN-42R-NS	42" (1.07m)	180gsm	25m	\$41.34 / roll
		BS-PH-180SN-50R-NS	50" (1.27m)	180gsm	25m	\$49.07 / roll
		BS-PH-180SN-60R-NS	60" (1.52m)	180gsm	25m	\$58.73 / roll
RC Silky W / P Photo Paper	BS-PH-230SN-NS	BS-PH-230SN-17R-NS	17" (0.43m)	230gsm	25m	\$19.64 / roll
		BS-PH-230SN-24R-NS	24" (0.61m)	230gsm	25m	\$27.85 / roll
		BS-PH-230SN-36R-NS	36" (0.914m)	230gsm	25m	\$41.74 / roll
		BS-PH-230SN-42R-NS	42" (1.07m)	230gsm	25m	\$48.86 / roll
		BS-PH-230SN-50R-NS	50" (1.27m)	230gsm	25m	\$57.99 / roll
		BS-PH-230SN-60R-NS	60" (1.52m)	230gsm	25m	\$69.4 / roll
RC Silky W / P Photo Paper	BS-PH-260SN-NS	BS-PH-260SN-17R-NS	17" (0.43m)	260gsm	25m	\$21.15 / roll
		BS-PH-260SN-24R-NS	24" (0.61m)	260gsm	25m	\$30.00 / roll
		BS-PH-260SN-36R-NS	36" (0.914m)	260gsm	25m	\$44.95 / roll
		BS-PH-260SN-42R-NS	42" (1.07m)	260gsm	25m	\$52.62 / roll
		BS-PH-260SN-50R-NS	50" (1.27m)	260gsm	25m	\$62.45 / roll
		BS-PH-260SN-60R-NS	60" (1.52m)	260gsm	25m	\$74.74 / roll
RC Velvet W / P Photo Paper	BS-PH-180NS-NS	BS-PH-180NS-17R-NS	17" (0.43m)	180gsm	25m	\$16.62 / roll
		BS-PH-180NS-24R-NS	24" (0.61m)	180gsm	25m	\$23.57 / roll
		BS-PH-180NS-36R-NS	36" (0.914m)	180gsm	25m	\$35.32 / roll
		BS-PH-180NS-42R-NS	42" (1.07m)	180gsm	25m	\$41.34 / roll
		BS-PH-180NS-50R-NS	50" (1.27m)	180gsm	25m	\$49.07 / roll
		BS-PH-180NS-60R-NS	60" (1.52m)	180gsm	25m	\$58.73 / roll
RC Velvet W / P Photo Paper	BS-PH-230NS-NS	BS-PH-230NS-17R-NS	17" (0.43m)	230gsm	25m	\$19.64 / roll
		BS-PH-230NS-24R-NS	24" (0.61m)	230gsm	25m	\$27.85 / roll
		BS-PH-230NS-36R-NS	36" (0.914m)	230gsm	25m	\$41.74 / roll
		BS-PH-230NS-42R-NS	42" (1.07m)	230gsm	25m	\$48.86 / roll
		BS-PH-230NS-50R-NS	50" (1.27m)	230gsm	25m	\$57.99 / roll
		BS-PH-230NS-60R-NS	60" (1.52m)	230gsm	25m	\$69.40 / roll

## &gt; Materials and Inks &gt; Indoor inkjet media &gt; glossy RC water - proof media

Name	Series	Code	Width / roll	Weight	Length	Price
RC Velvet W / P Photo Paper	BS-PH-260NS-NS	BS-PH-260NS-17R-NS	17" (0.43m)	260gsm	25m	\$21.15 / roll
		BS-PH-260NS-24R-NS	24" (0.61m)	260gsm	25m	\$30 / roll
		BS-PH-260NS-36R-NS	36" (0.914m)	260gsm	25m	\$44.95 / roll
		BS-PH-260NS-42R-NS	42" (1.07m)	260gsm	25m	\$52.62 / roll
		BS-PH-260NS-50R-NS	50" (1.27m)	260gsm	25m	\$62.45 / roll
		BS-PH-260NS-60R-NS	60" (1.52m)	260gsm	25m	\$74.74 / roll
Glossy W / P Photo Paper S / A	BS-PH-180GNL-NS	BS-PH-180GNL-17R-NS	17" (0.43m)	180gsm	25m	\$21.15 / roll
		BS-PH-180GNL-24R-NS	24" (0.61m)	180gsm	25m	\$30.00 / roll
		BS-PH-180GNL-36R-NS	36" (0.914m)	180gsm	25m	\$44.95 / roll
		BS-PH-180GNL-42R-NS	42" (1.07m)	180gsm	25m	\$52.62 / roll
		BS-PH-180GNL-50R-NS	50" (1.27m)	180gsm	25m	\$62.45 / roll
		BS-PH-180GNL-60R-NS	60" (1.52m)	180gsm	25m	\$74.74 / roll
Glossy W / P Photo Paper S / A	BS-PH-220GNL-NS	BS-PH-220GNL-17R-NS	17" (0.43m)	220gsm	25m	\$22.65 / roll
		BS-PH-220GNL-24R-NS	24" (0.61m)	220gsm	25m	\$37 / roll
		BS-PH-220GNL-36R-NS	36" (0.914m)	220gsm	25m	\$48.15 / roll
		BS-PH-220GNL-42R-NS	42" (1.07m)	220gsm	25m	\$56.37 / roll
		BS-PH-220GNL-50R-NS	50" (1.27m)	220gsm	25m	\$66.91 / roll
		BS-PH-220GNL-60R-NS	60" (1.52m)	220gsm	25m	\$80.08 / roll
Glossy W / P Photo Paper S / A	BS-PH-260GNL-NS	BS-PH-260GNL-17R-NS	17" (0.43m)	260gsm	25m	\$24.17 / roll
		BS-PH-260GNL-24R-NS	24" (0.61m)	260gsm	25m	\$34.28 / roll
		BS-PH-260GNL-36R-NS	36" (0.914m)	260gsm	25m	\$51.37 / roll
		BS-PH-260GNL-42R-NS	42" (1.07m)	260gsm	25m	\$60.13 / roll
		BS-PH-260GNL-50R-NS	50" (1.27m)	260gsm	25m	\$71.37 / roll
		BS-PH-260GNL-60R-NS	60" (1.52m)	260gsm	25m	\$85.43 / roll

Name	Series	Code	Width / roll	Weight	Length	Price
Glossy W / R Front Print Backlit Film	BS-TF-100GN-NS	BS-TF-100GN-36R-NS	36" (0.914m)	100µm	30m	\$53.93 / roll
		BS-TF-100GN-42R-NS	42" (1.07m)	100µm	30m	\$63.14 / roll
		BS-TF-100GN-50R-NS	50" (1.27m)	100µm	30m	\$74.94 / roll
		BS-TF-100GN-60R-NS	60" (1.52m)	100µm	30m	\$89.69 / roll
Glossy W / R Front Print Backlit Film	BS-TF-200GN-NS	BS-TF-200GN-36R-NS	36" (0.914m)	200µm	30m	\$77.04 / roll
		BS-TF-200GN-42R-NS	42" (1.07m)	200µm	30m	\$90.20 / roll
		BS-TF-200GN-50R-NS	50" (1.27m)	200µm	30m	\$107.06 / roll
Glossy W / R PP with Self - adhesive	BS-120GNL-NS	BS-TF-200GN-60R-NS	60" (1.52m)	200µm	30m	\$128.13 / roll
		BS-120GNL-36R-NS	36" (0.914m)	120µm	30m	\$53.83 / roll
		BS-120GNL-42R-NS	42" (1.07m)	120µm	30m	\$63.14 / roll
		BS-120GNL-50R-NS	50" (1.27m)	120µm	30m	\$74.94 / roll
Glossy W / R PP with Self - adhesive	BS-150GNL-NS	BS-120GNL-60R-NS	60" (1.52m)	120µm	30m	\$89.69 / roll
		BS-150GNL-36R-NS	36" (0.914m)	150µm	30m	\$57.78 / roll
		BS-150GNL-42R-NS	42" (1.07m)	150µm	30m	\$67.65 / roll
Glossy W / P PP Film	BS-150GN-NS	BS-150GNL-50R-NS	50" (1.27m)	150µm	30m	\$80.29 / roll
		BS-150GNL-60R-NS	60" (1.52m)	150µm	30m	\$96.10 / roll
		BS-150GN-36R-NS	36" (0.914m)	150µm	30m	\$38.52 / roll
		BS-150GN-42R-NS	42" (1.07m)	150µm	30m	\$45.10 / roll
Glossy W / P PP Film	BS-180GN-NS	BS-150GN-50R-NS	50" (1.27m)	150µm	30m	\$53.53 / roll
		BS-150GN-60R-NS	60" (1.52m)	150µm	30m	\$64.06 / roll
		BS-180GN-36R-NS	36" (0.914m)	180µm	30m	\$42.37 / roll
		BS-180GN-42R-NS	42" (1.07m)	180µm	30m	\$49.61 / roll
Glossy W / RPVC with Self - adhesive	BS-BC-100GNP-NS	BS-180GN-50R-NS	50" (1.27m)	180µm	30m	\$58.88 / roll
		BS-180GN-60R-NS	60" (1.52m)	180µm	30m	\$70.47 / roll
		BS-BC-100GNP-36R-NS	36" (0.914m)	100µm	25m	\$61.00 / roll
		BS-BC-100GNP-42R-NS	42" (1.07m)	100µm	25m	\$71.41 / roll
		BS-BC-100GNP-50R-NS	50" (1.27m)	100µm	25m	\$84.75 / roll
		BS-BC-100GNP-60R-NS	60" (1.52m)	100µm	25m	\$101.44 / roll

## ECO Wall Paper

**Media Width:** 42" / 44" / 50" (1.07m / 1.12m / 1.52m)

**Media Length:** 30m / roll

**Suitable Inkjet Printers:** Mutoh, Roland, HP, Epson, Mimaki, Encad, etc.

**Suitable Inks:** Water - based ink, ECO ink, Pigment ink

ECO wall paper latest new environmental material, is fire - proof, water - proof, moisture - proof and no curl under damp conditions.

- Printed with ECO environmental ink, its saturation is good; No toxicity and the odor is small.
- This series of products could be customized. Customers can print various pictures up to their tastes so as to decorate their private room.
- It can be used for decoration in private rooms, offices, hotels, markets, etc.
- It's a kind of glossy white wall paper.

**About Price:** The price of advertising material products list on this book is the third ladder price. You can visit our website [www.sign-in-china.com](http://www.sign-in-china.com) for reference.

### ▼ Samples



### ▼ Specifications (Quotation according to sq. m)

Name	Series	Width	Thickness (± 0.05)	Weight (± 10)	Whiteness (±10%)	Price
Solvent Personalized Crushed Pattern Glossy Wallpaper (White)	BS-RTG-3220-ECO	1.07m (42")	0.26mm	258gsm	78.2	\$2.64 / sq. m
Solvent Personalized Crushed Pattern Glossy Wallpaper (Silver)	BS-RSG-3220-ECO	1.07m (42")	0.27mm	227gsm	51.6	\$3.12 / sq. m
Solvent Drawing Pattern Wallpaper (White)	BS-RLG-3220-ECO	1.07m (42")	0.26mm	227gsm	70.9	\$2.64 / sq. m
Solvent Flower Pattern Wallpaper (White)	BS-RHG-3220-ECO	1.07m (42")	0.29mm	245gsm	74.3	\$2.80 / sq. m
Solvent Personalized Matte Wallpaper (115g)	BS-RCS-3180-ECO	1.07m (42")	0.25mm	188gsm	76.3	\$1.65 / sq. m
Solvent Stone Pattern Glossy Wallpaper	BS-WPV-T01701-ECO	1.07m (42")	0.26mm	221gsm	70.4	\$2.96 / sq. m
Solvent Leather Pattern Glossy Wallpaper	BS-WPV-D80562-ECO	1.07m (42")	0.27mm	230gsm	74.5	\$2.96 / sq. m
Solvent Gold Sands Wallpaper	BS-WPV-A0008-ECO	1.07m (42")	0.27mm	260gsm	20.4	\$3.62 / sq. m
Solvent Silver Sands Wallpaper	BS-WPV-A0009-ECO	1.07m (42")	0.26mm	250gsm	59.1	\$3.67 / sq. m
Solvent Fine Pattern Wallpaper	BS-WPV-T02001-ECO	1.07m (42")	0.28mm	229gsm	71.5	\$2.80 / sq. m
Solvent TC Wallpaper	BS-WWP-QY12-2-ECO	1.12m (44")	0.34mm	221gsm	90.1	\$2.64 / sq. m
ECO Matte Waterproof Non - woven Fabric	BS-WWS-3090-ECO	1.12m (44")	0.47mm	356gsm	78.3	\$1.49 / sq. m
ECO Backlit Waterproof Banner Fabric	BS-EAS-3150-ECO	1.27m (50")	0.32mm	329gsm	85.8	\$2.96 / sq. m
ECO Backlit Cotton Canvas	BS-CAS-3500-ECO	1.27m (50")	0.67mm	581gsm	86.0	\$5.28 / sq. m
Solvent Thick Pattern Charpie	BS-FRS-3220-ECO	1.07m (42")	0.47mm	179gsm	77.6	\$3.46 / sq. m

### ▼ Specifications (Quotation according to roll)

Name	Series	Code	Width	Weight	Thickness	Price
Solvent Personalized Crushed Pattern Glossy Wallpaper (White)	BS-RTG-3220-ECO	BS-RTG-3220-42R-ECO	42" (1.07m)	258gsm	0.26mm	\$84.66 / roll
Solvent Personalized Crushed Pattern Glossy Wallpaper (Silver)	BS-RSG-3220-ECO	BS-RSG-3220-42R-ECO	42" (1.07m)	227gsm	0.27mm	\$100.17 / roll
Solvent Drawing Pattern Wallpaper (White)	BS-RLG-3220-ECO	BS-RLG-3220-42R-ECO	42" (1.07m)	227gsm	0.26mm	\$4.66 / roll
Solvent Flower Pattern Wallpaper (White)	BS-RHG-3220-ECO	BS-RHG-3220-42R-ECO	42" (1.07m)	245gsm	0.29mm	\$89.84 / roll
Solvent Personalized Matte Wallpaper (115g)	BS-RCS-3180-ECO	BS-RCS-3180-42R-ECO	42" (1.07m)	188gsm	0.25mm	\$52.84 / roll
Solvent Stone Pattern Glossy Wallpaper	BS-WPV-T01701-ECO	BS-WPV-T01701-42R-ECO	42" (1.07m)	221gsm	0.26mm	\$95.00 / roll
Solvent Leather Pattern Glossy Wallpaper	BS-WPV-D80562-ECO	BS-WPV-D80562-42R-ECO	42" (1.07m)	230gsm	0.27mm	\$95.00 / roll
Solvent Gold Sands Wallpaper	BS-WPV-A0008-ECO	BS-WPV-A0008-42R-ECO	42" (1.07m)	260gsm	0.27mm	\$116.33 / roll
Solvent Silver Sands Wallpaper	BS-WPV-A0009-ECO	BS-WPV-A0009-42R-ECO	42" (1.07m)	250gsm	0.26mm	\$117.78 / roll
Solvent Fine Pattern Wallpaper	BS-WPV-T02001-ECO	BS-WPV-T02001-42R-ECO	42" (1.07m)	229gsm	0.28mm	\$89.84 / roll
Solvent TC Wallpaper	BS-WWP-QY12-2-ECO	BS-WWP-QY12-2-44R-ECO	44" (1.12m)	221gsm	0.34mm	\$88.54 / roll
ECO Matte Waterproof Non - woven Fabric	BS-WWS-3090-ECO	BS-WWS-3090-44R-ECO	44" (1.12m)	356gsm	0.47mm	\$49.93 / roll
ECO Backlit Waterproof Banner Fabric	BS-EAS-3150-ECO	BS-EAS-3150-50R-ECO	50" (1.27m)	329gsm	0.32mm	\$112.94 / roll
ECO Backlit Cotton Canvas	BS-CAS-3500-ECO	BS-CAS-3500-50R-ECO	50" (1.27m)	581gsm	0.67mm	\$200.99 / roll
Solvent Thick Pattern Charpie	BS-FRS-3220-ECO	BS-FRS-3220-42RECO	42" (1.07m)	179gsm	0.47mm	\$111.00 / roll



## Inkjet Media in Pigment Ink

**Media Width:** 24" / 36" / 42" / 50" / 60" (0.61m / 0.914m / 1.07m / 1.27m / 1.52m)

**Media Length:** 25m or 30m per roll

**Suitable Inkjet Printers:** Mutoh, Roland, HP, Epson, Mimaki, Encad, etc.

**Suitable Inks:** Pigment ink

**About Price:** The price of advertising material products list on this book is the third ladder price. You can visit our website [www.sign-in-china.com](http://www.sign-in-china.com) for reference.

### Notes:

1. Don't open the package to uncover the products in high humidity environment, avoiding affecting the absorbing speed.
2. Please wear the cotton gloves when you touching the pictures to avoid the pinhole.

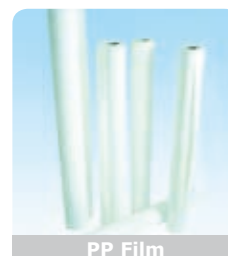
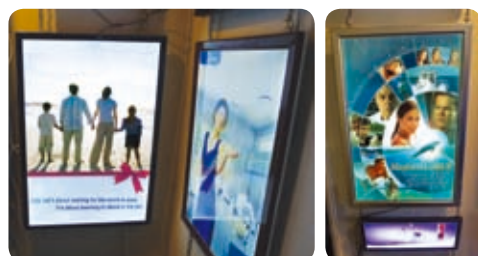
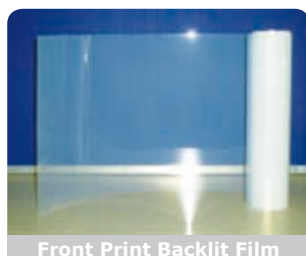

### ▼ Specifications (Quotation according to sq. m) 25m, 30m / roll

Name	Series	Thickness	Width	Price
Glossy PP Film	BS-150GU-NS	150µm	36" / 42" / 50" / 60" (0.914m / 1.07m / 1.27m / 1.52m)	\$1.12 / sq. m
Glossy PP Film	BS-180GU-NS	180µm	36" / 42" / 50" / 60" (0.914m / 1.07m / 1.27m / 1.52m)	\$1.26 / sq. m
Matte PP Film	BS-150SU-NS	150µm	36" / 42" / 50" / 60" (0.914m / 1.07m / 1.27m / 1.52m)	\$1.12 / sq. m
Matte PP Film	BS-180SU-NS	180µm	36" / 42" / 50" / 60" (0.914m / 1.07m / 1.27m / 1.52m)	\$1.26 / sq. m
Glossy PP Film S / A	BS-120GUL-NS	120µm	36" / 42" / 50" / 60" (0.914m / 1.07m / 1.27m / 1.52m)	\$1.40 / sq. m
Glossy PP Film S / A	BS-150GUL-NS	150µm	36" / 42" / 50" / 60" (0.914m / 1.07m / 1.27m / 1.52m)	\$1.40 / sq. m
Glossy PP Film S / A	GBS-120GUL-NS	120µm	36" / 42" / 50" / 60" (0.914m / 1.07m / 1.27m / 1.52m)	\$1.40 / sq. m
Matte PP Film S / A	BS-120SUL-NS	120µm	36" / 42" / 50" / 60" (0.914m / 1.07m / 1.27m / 1.52m)	\$1.26 / sq. m
Matte PP Film S / A	BS-150SULBS	150µm	36" / 42" / 50" / 60" (0.914m / 1.07m / 1.27m / 1.52m)	\$1.40 / sq. m
Matte PP Film S / A	GBS-120SUL-NS	120µm	36" / 42" / 50" / 60" (0.914m / 1.07m / 1.27m / 1.52m)	\$1.40 / sq. m
Front Print Backlit Film	BS-FB-210SU-NS	210µm	36" / 42" / 50" / 60" (0.914m / 1.07m / 1.27m / 1.52m)	\$1.97 / sq. m
Front Print Backlit Film	BS-TF-130SU-NS	130µm	36" / 42" / 50" / 60" (0.914m / 1.07m / 1.27m / 1.52m)	\$1.83 / sq. m
Glossy White PVC	BS-BC-100GUP-NS	100µm	36" / 42" / 50" / 60" (0.914m / 1.07m / 1.27m / 1.52m)	\$2.11 / sq. m

Name	Series	Weight	Width	Price
Glossy Photo Paper	BS-PH-180GU-NS	180gsm	24" / 36" / 42" / 50" / 60" (0.61m / 0.914m / 1.07m / 1.27m / 1.52m)	\$1.12 / sq. m
Glossy Photo Paper	BS-PH-220GU-NS	220gsm	24" / 36" / 42" / 50" / 60" (0.61m / 0.914m / 1.07m / 1.27m / 1.52m)	\$1.26 / sq. m
Matte Photo Paper	BS-PH-180SU-NS	180gsm	24" / 36" / 42" / 50" / 60" (0.61m / 0.914m / 1.07m / 1.27m / 1.52m)	\$1.12 / sq. m
Matte Photo Paper	BS-PH-220SU-NS	220gsm	24" / 36" / 42" / 50" / 60" (0.61m / 0.914m / 1.07m / 1.27m / 1.52m)	\$1.26 / sq. m

### ▼ Specifications (Quotation according to roll)

Name	Series	Code	Width	Thickness	Length / roll	Price
Glossy PP Film	BS-150GU-NS	BS-150GU-36R-NS	36" (0.914m)	150µm	30m	\$30.82 / roll
		BS-150GU-42R-NS	42" (1.07m)	150µm	30m	\$30.82 / roll
		BS-150GU-50R-NS	50" (1.27m)	150µm	30m	\$42.82 / roll
		BS-150GU-60R-NS	60" (1.52m)	150µm	30m	\$51.26 / roll
Glossy PP Film	BS-180GU-NS	BS-180GU-36R-NS	36" (0.914m)	180µm	30m	\$34.67 / roll
		BS-180GU-42R-NS	42" (1.07m)	180µm	30m	\$40.58 / roll
		BS-180GU-50R-NS	50" (1.27m)	180µm	30m	\$48.18 / roll
		BS-180GU-60R-NS	60" (1.52m)	180µm	30m	\$57.66 / roll
Matte PP Film	BS-150SU-NS	BS-150SU-36R-NS	36" (0.914m)	150µm	30m	\$30.82 / roll
		BS-150SU-42R-NS	42" (1.07m)	150µm	30m	\$30.82 / roll
		BS-150SU-50R-NS	50" (1.27m)	150µm	30m	\$42.82 / roll
		BS-150SU-60R-NS	60" (1.52m)	150µm	30m	\$51.26 / roll
Matte PP Film	BS-180SU-NS	BS-180SU-36R-NS	36" (0.914m)	180µm	30m	\$34.67 / roll
		BS-180SU-42R-NS	42" (1.07m)	180µm	30m	\$40.58 / roll
		BS-180SU-50R-NS	50" (1.27m)	180µm	30m	\$48.18 / roll
		BS-180SU-60R-NS	60" (1.52m)	180µm	30m	\$57.66 / roll

## &gt; Materials and Inks &gt; Indoor inkjet media &gt; inkjet media in pigment ink

Name	Series	Code	Width	Thickness	Length / roll	Price
Glossy PP Film S / A	BS-120GUL-NS	BS-120GUL-36R-NS	36" (0.914m)	120µm	30m	\$38.52 / roll
		BS-120GUL-42R-NS	42" (1.07m)	120µm	30m	\$45.1 / roll
		BS-120GUL-50R-NS	50" (1.27m)	120µm	30m	\$53.53 / roll
		BS-120GUL-60R-NS	60" (1.52m)	120µm	30m	\$64.6 / roll
Glossy PP Film S / A	BS-150GUL-NS	BS-150GUL-36R-NS	36" (0.914m)	150µm	30m	\$38.52 / roll
		BS-150GUL-42R-NS	42" (1.07m)	150µm	30m	\$45.1 / roll
		BS-150GUL-50R-NS	50" (1.27m)	150µm	30m	\$53.53 / roll
		BS-150GUL-60R-NS	60" (1.52m)	150µm	30m	\$64.6 / roll
Glossy PP Film S / A	GBS-120GUL-NS	GBS-120GUL-36R-NS	36" (0.914m)	120µm	30m	\$38.52 / roll
		GBS-120GUL-42R-NS	42" (1.07m)	120µm	30m	\$45.1 / roll
		GBS-120GUL-50R-NS	50" (1.27m)	120µm	30m	\$53.53 / roll
		GBS-120GUL-60R-NS	60" (1.52m)	120µm	30m	\$64.6 / roll
Matte PP Film S / A	BS-120SUL-NS	BS-120SUL-36R-NS	36" (0.914m)	120µm	30m	\$38.52 / roll
		BS-120SUL-42R-NS	42" (1.07m)	120µm	30m	\$45.1 / roll
		BS-120SUL-50R-NS	50" (1.27m)	120µm	30m	\$53.53 / roll
		BS-120SUL-60R-NS	60" (1.52m)	120µm	30m	\$64.6 / roll
Matte PP Film S / A	BS-150SULBS	BS-150SULBS-36R	36" (0.914m)	150µm	30m	\$38.52 / roll
		BS-150SULBS-42R	42" (1.07m)	150µm	30m	\$45.1 / roll
		BS-150SULBS-50R	50" (1.27m)	150µm	30m	\$53.53 / roll
		BS-150SULBS-60R	60" (1.52m)	150µm	30m	\$64.6 / roll
Matte PP Film S / A	GBS-120SUL-NS	GBS-120SUL-36R-NS	36" (0.914m)	120µm	30m	\$38.52 / roll
		GBS-120SUL-42R-NS	42" (1.07m)	120µm	30m	\$45.1 / roll
		GBS-120SUL-50R-NS	50" (1.27m)	120µm	30m	\$53.53 / roll
		GBS-120SUL-60R-NS	60" (1.52m)	120µm	30m	\$64.6 / roll
Front Print Backlit Film	BS-FB-210SU-NS	BS-FB-210SU-36R-NS	36" (0.914m)	210µm	30m	\$53.93 / roll
		BS-FB-210SU-42R-NS	42" (1.07m)	210µm	30m	\$63.14 / roll
		BS-FB-210SU-50R-NS	50" (1.27m)	210µm	30m	\$75.06 / roll
		BS-FB-210SU-60R-NS	60" (1.52m)	210µm	30m	\$89.83 / roll
Front Print Backlit Film	BS-TF-130SU-NS	BS-TF-130SU-36R-NS	36" (0.914m)	130µm	30m	\$50.08 / roll
		BS-TF-130SU-42R-NS	42" (1.07m)	130µm	30m	\$58.63 / roll
		BS-TF-130SU-50R-NS	50" (1.27m)	130µm	30m	\$69.59 / roll
		BS-TF-130SU-60R-NS	60" (1.52m)	130µm	30m	\$83.28 / roll
Glossy White PVC	BS-BC-100GUP-NS	BS-BC-100GUP-36R-NS	36" (0.914m)	100µm	30m	\$57.78 / roll
		BS-BC-100GUP-42R-NS	42" (1.07m)	100µm	30m	\$67.65 / roll
		BS-BC-100GUP-50R-NS	50" (1.27m)	100µm	30m	\$80.29 / roll
		BS-BC-100GUP-60R-NS	60" (1.52m)	100µm	30m	\$96.10 / roll

Name	Series	Code	Width	Weight	Length / roll	Price
Glossy Photo Paper	BS-PH-180GU-NS	BS-PH-180GU-24R-NS	24" (0.61m)	180gsm	30m	\$20.57 / roll
		BS-PH-180GU-36R-NS	36" (0.914m)	180gsm	30m	\$30.82 / roll
		BS-PH-180GU-42R-NS	42" (1.07m)	180gsm	30m	\$36.08 / roll
		BS-PH-180GU-50R-NS	50" (1.27m)	180gsm	30m	\$42.82 / roll
		BS-PH-180GU-60R-NS	60" (1.52m)	180gsm	30m	\$51.26 / roll
Glossy Photo Paper	BS-PH-220GU-NS	BS-PH-220GU-24R-NS	24" (0.61m)	220gsm	30m	\$23.14 / roll
		BS-PH-220GU-36R-NS	36" (0.914m)	220gsm	30m	\$34.67 / roll
		BS-PH-220GU-42R-NS	42" (1.07m)	220gsm	30m	\$40.59 / roll
		BS-PH-220GU-50R-NS	50" (1.27m)	220gsm	30m	\$48.18 / roll
Matte Photo Paper	BS-PH-180SU-NS	BS-PH-180SU-24R-NS	24" (0.61m)	180gsm	30m	\$20.57 / roll
		BS-PH-180SU-36R-NS	36" (0.914m)	180gsm	30m	\$30.82 / roll
		BS-PH-180SU-42R-NS	42" (1.07m)	180gsm	30m	\$36.08 / roll
		BS-PH-180SU-50R-NS	50" (1.27m)	180gsm	30m	\$42.82 / roll
		BS-PH-180SU-60R-NS	60" (1.52m)	180gsm	30m	\$51.26 / roll
Matte Photo Paper	BS-PH-220SU-NS	BS-PH-220SU-24R-NS	24" (0.61m)	220gsm	30m	\$23.14 / roll
		BS-PH-220SU-36R-NS	36" (0.914m)	220gsm	30m	\$34.67 / roll
		BS-PH-220SU-42R-NS	42" (1.07m)	220gsm	30m	\$40.59 / roll
		BS-PH-220SU-50R-NS	50" (1.27m)	220gsm	30m	\$48.18 / roll
		BS-PH-220SU-60R-NS	60" (1.52m)	220gsm	30m	\$57.66 / roll

## Indoor Inkjet Printing Media

Use water-based ink so picture can keep long time indoors with vivid color.

The coating is very fine and smooth with high brightness, high density, dry fast, extensive vivid color, owning very high definition and accuracy. It could well prevent problems of changing yellow and folding.

**Media Width:** 24" / 36" / 42" / 50" / 60" (0.61m / 0.914m / 1.07m / 1.27m / 1.52m)

**Media Length:** 25m or 30m per roll

**Suitable Inkjet Printers:** Mutoh, Roland, HP, Epson, Mimaki, Encad, etc.

**Suitable Inks:** Pigment ink

**About Price:** The price of advertising material products list on this book is the third ladder price. You can visit our website [www.sign-in-china.com](http://www.sign-in-china.com) for reference.

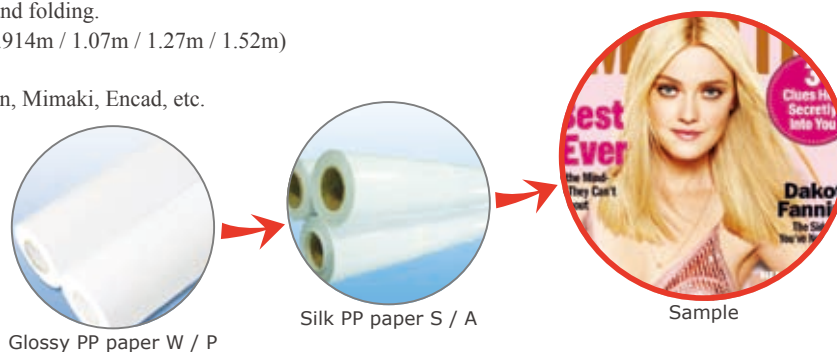

Glossy PP paper W / P

Silk PP paper S / A

Sample

### ▼ Specifications (Quotation according to sq. m) 25m, 30m / roll

Name	Series	Thickness	Width	Price
Glossy PP Film / Paper (I / D)	BS-150G-NS	150µm	36" / 42" / 50" / 60" (0.914m / 1.07m / 1.27m / 1.52m)	\$0.99 / sq. m
Glossy PP Film / Paper (I / D)	BS-180G-NS	180µm	36" / 42" / 50" / 60" (0.914m / 1.07m / 1.27m / 1.52m)	\$1.15 / sq. m
Matte PP Film / Paper (I / D)	BS-150S-NS	150µm	36" / 42" / 50" / 60" (0.914m / 1.07m / 1.27m / 1.52m)	\$0.99 / sq. m
Matte PP Film/ Paper (I / D)	BS-180S-NS	180µm	36" / 42" / 50" / 60" (0.914m / 1.07m / 1.27m / 1.52m)	\$1.15 / sq. m
Glossy PP Film S / A (I / D)	BS-120GL-NS	120µm	36" / 42" / 50" / 60" (0.914m / 1.07m / 1.27m / 1.52m)	\$1.33 / sq. m
Glossy PP Film S / A (I / D)	BS-150GL-NS	150µm	36" / 42" / 50" / 60" (0.914m / 1.07m / 1.27m / 1.52m)	\$1.15 / sq. m
Glossy PP Film S / A (I / D)	BS-GBS-120GL-NS	120µm	36" / 42" / 50" / 60" (0.914m / 1.07m / 1.27m / 1.52m)	\$1.31 / sq. m
Matte PP Film S / A (I / D)	BS-120SL-NS	120µm	36" / 42" / 50" / 60" (0.914m / 1.07m / 1.27m / 1.52m)	\$1.15 / sq. m
Matte PP Film S / A (I / D)	BS-150SL-NS	150µm	36" / 42" / 50" / 60" (0.914m / 1.07m / 1.27m / 1.52m)	\$1.15 / sq. m
Matte PP Film S / A (I / D)	BS-GBS-120SL-NS	120µm	36" / 42" / 50" / 60" (0.914m / 1.07m / 1.27m / 1.52m)	\$1.15 / sq. m
Glossy White PVC Vinyl (Paper liner) (I / D)	BS-BC-100GP-NS	100µm	36" / 42" / 50" / 60" (0.914m / 1.07m / 1.27m / 1.52m)	\$2.47 / sq. m
Glossy White PVC Vinyl (PET liner) (I / D)	BS-BC-100GL-NS	100µm	36" / 42" / 50" / 60" (0.914m / 1.07m / 1.27m / 1.52m)	\$2.47 / sq. m
Transparent PET Film (I / D)	BS-TF-100T-NS	100µm	36" / 42" / 50" / 60" (0.914m / 1.07m / 1.27m / 1.52m)	\$1.15 / sq. m
Transparent PET Film S / A (I / D)	BS-TF-100TL-NS	100µm	36" / 42" / 50" / 60" (0.914m / 1.07m / 1.27m / 1.52m)	\$2.47 / sq. m
Front Print Backlit Film (I / D)	BS-TF-100S-NS	100µm	36" / 42" / 50" / 60" (0.914m / 1.07m / 1.27m / 1.52m)	\$1.97 / sq. m
Front Print Backlit Film (I / D)	BS-TF-200S-NS	200µm	36" / 42" / 50" / 60" (0.914m / 1.07m / 1.27m / 1.52m)	\$2.63 / sq. m
Front Print Backlit Film (I / D)	BS-FB-110S-NS	110µm	36" / 42" / 50" / 60" (0.914m / 1.07m / 1.27m / 1.52m)	\$1.65 / sq. m
Front Print Backlit Film (I / D)	BS-FB-210S-NS	210µm	36" / 42" / 50" / 60" (0.914m / 1.07m / 1.27m / 1.52m)	\$2.47 / sq. m
Front Print Backlit Film S / A (I / D)	BS-FB-100SL-NS	100µm	36" / 42" / 50" / 60" (0.914m / 1.07m / 1.27m / 1.52m)	\$1.65 / sq. m
Rigid Glossy PVC Sheet (I / D)	BS-BC-180G-NS	180µm	24" / 36" / 42" / 50" / 60" (0.61m / 0.914m / 1.07m / 1.27m / 1.52m)	\$1.65 / sq. m
Rigid Matte PVC Sheet (I / D)	BS-BC-180S-NS	180µm	36" / 42" / 50" / 60" (0.914m / 1.07m / 1.27m / 1.52m)	\$1.65 / sq. m

Name	Series	Weight	Width	Price
Glossy Photo Paper (I / D)	BS-PH-150G-NS	150gsm	24" / 36" / 42" / 50" / 60" (0.61m / 0.914m / 1.07m / 1.27m / 1.52m)	\$0.99 / sq. m
Glossy Photo Paper (I / D)	BS-PH-180G-NS	180gsm	24" / 36" / 42" / 50" / 60" (0.61m / 0.914m / 1.07m / 1.27m / 1.52m)	\$0.99 / sq. m
Glossy Photo Paper (I / D)	BS-PH-220G-NS	220gsm	24" / 36" / 42" / 50" / 60" (0.61m / 0.914m / 1.07m / 1.27m / 1.52m)	\$1.15 / sq. m
Matte Photo Paper (I / D)	BS-PH-150S-NS	150gsm	24" / 36" / 42" / 50" / 60" (0.61m / 0.914m / 1.07m / 1.27m / 1.52m)	\$0.99 / sq. m
Matte Photo Paper (I / D)	BS-PH-180S-NS	180gsm	24" / 36" / 42" / 50" / 60" (0.61m / 0.914m / 1.07m / 1.27m / 1.52m)	\$0.99 / sq. m
Matte Photo Paper (I / D)	BS-PH-220S-NS	220gsm	24" / 36" / 42" / 50" / 60" (0.61m / 0.914m / 1.07m / 1.27m / 1.52m)	\$1.15 / sq. m
Glossy Photo Paper S / A (I / D)	BS-PH-150GL-NS	150gsm	36" / 42" / 50" / 60" (0.914m / 1.07m / 1.27m / 1.52m)	\$1.31 / sq. m

### ▼ Specifications (Quotation according to roll)

Name	Series	Code	Width	Thickness	Length / roll	Price
Glossy PP Film / Paper (I / D)	BS-150G-NS	BS-150G-36R-NS	36" (0.914m)	150µm	30m	\$27.14 / roll
		BS-150G-42R-NS	42" (1.07m)	150µm	30m	\$31.67 / roll
		BS-150G-50R-NS	50" (1.27m)	150µm	30m	\$37.49 / roll
		BS-150G-60R-NS	60" (1.52m)	150µm	30m	\$44.91 / roll

## &gt; Materials and Inks &gt; Indoor inkjet media &gt; indoor inkjet printing media

Name	Series	Code	Width	Thickness	Length / roll	Price
Glossy PP Film / Paper (I / D)	BS-180G-NS	BS-180G-36R-NS	36" (0.914m)	180µm	30m	\$31.51 / roll
		BS-180G-42R-NS	42" (1.07m)	180µm	30m	\$36.84 / roll
		BS-180G-50R-NS	50" (1.27m)	180µm	30m	\$43.95 / roll
		BS-180G-60R-NS	60" (1.52m)	180µm	30m	\$52.35 / roll
Matte PP Film / Paper (I / D)	BS-150S-NS	BS-150S-36R-NS	36" (0.914m)	150µm	30m	\$27.14 / roll
		BS-150S-42R-NS	42" (1.07m)	150µm	30m	\$31.10 / roll
		BS-150S-50R-NS	50" (1.27m)	150µm	30m	\$31.67 / roll
		BS-150S-60R-NS	60" (1.52m)	150µm	30m	\$44.91 / roll
Matte PP Film / Paper (I / D)	BS-180S-NS	BS-180S-36R-NS	36" (0.914m)	180µm	30m	\$31.51 / roll
		BS-180S-42R-NS	42" (1.07m)	180µm	30m	\$36.84 / roll
		BS-180S-50R-NS	50" (1.27m)	180µm	30m	\$43.95 / roll
		BS-180S-60R-NS	60" (1.52m)	180µm	30m	\$52.35 / roll
Glossy PP Film S / A (I / D)	BS-120GL-NS	BS-120GL-36R-NS	36" (0.914m)	120µm	30m	\$35.87 / roll
		BS-120GL-42R-NS	42" (1.07m)	120µm	30m	\$42.01 / roll
		BS-120GL-50R-NS	50" (1.27m)	120µm	30m	\$49.93 / roll
		BS-120GL-60R-NS	60" (1.52m)	120µm	30m	\$59.78 / roll
Glossy PP Film S / A (I / D)	BS-150GL-NS	BS-150GL-36R-NS	36" (0.914m)	150µm	30m	\$31.51 / roll
		BS-150GL-42R-NS	42" (1.07m)	150µm	30m	\$36.84 / roll
		BS-150GL-50R-NS	50" (1.27m)	150µm	30m	\$43.95 / roll
		BS-150GL-60R-NS	60" (1.52m)	150µm	30m	\$52.35 / roll
Glossy PP Film S / A (I / D)	BS-GBS-120GL-NS	BS-GBS-120GL-36R-NS	36" (0.914m)	120µm	30m	\$35.87 / roll
		BS-GBS-120GL-42R-NS	42" (1.07m)	120µm	30m	\$42.01 / roll
		BS-GBS-120GL-50R-NS	50" (1.27m)	120µm	30m	\$49.93 / roll
		BS-GBS-120GL-60R-NS	60" (1.52m)	120µm	30m	\$59.78 / roll
Matte PP Film S / A (I / D)	BS-120SL-NS	BS-120SL-36R-NS	36" (0.914m)	120µm	30m	\$31.51 / roll
		BS-120SL-42R-NS	42" (1.07m)	120µm	30m	\$36.84 / roll
		BS-120SL-50R-NS	50" (1.27m)	120µm	30m	\$43.95 / roll
		BS-120SL-60R-NS	60" (1.52m)	120µm	30m	\$52.35 / roll
Matte PP Film S / A (I / D)	BS-150SL-NS	BS-150SL-36R-NS	36" (0.914m)	150µm	30m	\$31.51 / roll
		BS-150SL-42R-NS	42" (1.07m)	150µm	30m	\$36.84 / roll
		BS-150SL-50R-NS	50" (1.27m)	150µm	30m	\$43.95 / roll
		BS-150SL-60R-NS	60" (1.52m)	150µm	30m	\$52.35 / roll
Matte PP Film S / A (I / D)	BS-GBS-120SL-NS	BS-GBS-120SL-36R-NS	36" (0.914m)	120µm	30m	\$31.51 / roll
		BS-GBS-120SL-42R-NS	42" (1.07m)	120µm	30m	\$36.84 / roll
		BS-GBS-120SL-50R-NS	50" (1.27m)	120µm	30m	\$43.95 / roll
		BS-GBS-120SL-60R-NS	60" (1.52m)	120µm	30m	\$52.35 / roll
Glossy White PVC Vinyl (Paper liner) (I / D)	BS-BC-100GP-NS	BS-BC-100GP-36R-NS	36" (0.914m)	100µm	30m	\$67.86 / roll
		BS-BC-100GP-42R-NS	42" (1.07m)	100µm	30m	\$79.33 / roll
		BS-BC-100GP-50R-NS	50" (1.27m)	100µm	30m	\$94.20 / roll
		BS-BC-100GP-60R-NS	60" (1.52m)	100µm	30m	\$112.78 / roll
Glossy White PVC Vinyl (PET liner) (I / D)	BS-BC-100GL-NS	BS-BC-100GL-36R-NS	36" (0.914m)	100µm	30m	\$67.86 / roll
		BS-BC-100GL-42R-NS	42" (1.07m)	100µm	30m	\$79.33 / roll
		BS-BC-100GL-50R-NS	50" (1.27m)	100µm	30m	\$94.20 / roll
		BS-BC-100GL-60R-NS	60" (1.52m)	100µm	30m	\$112.78 / roll
Transparent PET Film (I / D)	BS-TF-100T-NS	BS-TF-100T-36R-NS	36" (0.914m)	100µm	30m	\$31.51 / roll
		BS-TF-100T-42R-NS	42" (1.07m)	100µm	30m	\$36.84 / roll
		BS-TF-100T-50R-NS	50" (1.27m)	100µm	30m	\$43.95 / roll
		BS-TF-100T-60R-NS	60" (1.52m)	100µm	30m	\$52.35 / roll
Transparent PET Film S / A (I / D)	BS-TF-100TL-NS	BS-TF-100TL-36R-NS	36" (0.914m)	100µm	30m	\$67.86 / roll
		BS-TF-100TL-42R-NS	42" (1.07m)	100µm	30m	\$79.33 / roll
		BS-TF-100TL-50R-NS	50" (1.27m)	100µm	30m	\$94.20 / roll
		BS-TF-100TL-60R-NS	60" (1.52m)	100µm	30m	\$112.78 / roll
Front Print Backlit Film (I / D)	BS-TF-100S-NS	BS-TF-100S-36R-NS	36" (0.914m)	100µm	30m	\$54.13 / roll
		BS-TF-100S-42R-NS	42" (1.07m)	100µm	30m	\$63.33 / roll
		BS-TF-100S-50R-NS	50" (1.27m)	100µm	30m	\$75.13 / roll
		BS-TF-100S-60R-NS	60" (1.52m)	100µm	30m	\$90.00 / roll
Front Print Backlit Film (I / D)	BS-TF-200S-NS	BS-TF-200S-36R-NS	36" (0.914m)	200µm	30m	\$72.22 / roll
		BS-TF-200S-42R-NS	42" (1.07m)	200µm	30m	\$84.50 / roll
		BS-TF-200S-50R-NS	50" (1.27m)	200µm	30m	\$100.5 / roll
		BS-TF-200S-60R-NS	60" (1.52m)	200µm	30m	\$120.21 / roll

## &gt; Materials and Inks &gt; Indoor inkjet media &gt; indoor inkjet printing media

Name	Series	Code	Width	Thickness	Length / roll	Price
Front Print Backlit Film (I / D)	BS-FB-110S-NS	BS-FB-110S-36R-NS	36" (0.914m)	110µm	30m	\$45.24 / roll
		BS-FB-110S-42R-NS	42" (1.07m)	110µm	30m	\$52.84 / roll
		BS-FB-110S-50R-NS	50" (1.27m)	110µm	30m	\$62.69 / roll
		BS-FB-110S-60R-NS	60" (1.52m)	110µm	30m	\$75.13 / roll
Front Print Backlit Film (I / D)	BS-FB-210S-NS	BS-FB-210S-36R-NS	36" (0.914m)	210µm	30m	\$67.86 / roll
		BS-FB-210S-42R-NS	42" (1.07m)	210µm	30m	\$79.33 / roll
		BS-FB-210S-50R-NS	50" (1.27m)	210µm	30m	\$94.20 / roll
Front Print Backlit Film S / A (I / D)	BS-FB-100SL-NS	BS-FB-100SL-36R-NS	36" (0.914m)	100µm	30m	\$45.24 / roll
		BS-FB-100SL-42R-NS	42" (1.07m)	100µm	30m	\$52.84 / roll
		BS-FB-100SL-50R-NS	50" (1.27m)	100µm	30m	\$62.69 / roll
		BS-FB-100SL-60R-NS	60" (1.52m)	100µm	30m	\$63.14 / roll
Rigid Glossy PVC Sheet (I / D)	BS-BC-180G-NS	BS-BC-180G-36R-NS	36" (0.914m)	180µm	30m	\$45.24 / roll
		BS-BC-180G-42R-NS	42" (1.07m)	180µm	30m	\$52.84 / roll
		BS-BC-180G-50R-NS	50" (1.27m)	180µm	30m	\$62.69 / roll
Rigid Matte PVC Sheet (I / D)	BS-BC-180S-NS	BS-BC-180S-36R-NS	36" (0.914m)	180µm	30m	\$45.24 / roll
		BS-BC-180S-42R-NS	42" (1.07m)	180µm	30m	\$52.84 / roll
		BS-BC-180S-50R-NS	50" (1.27m)	180µm	30m	\$62.69 / roll
		BS-BC-180S-60R-NS	60" (1.52m)	180µm	30m	\$75.13 / roll

Name	Series	Code	Width	Weight	Length / roll	Price
Glossy Photo Paper (I / D)	BS-PH-150G-NS	BS-PH-150G-24R-NS	24" (0.61m)	150gsm	30m	\$17.94 / roll
		BS-PH-150G-36R-NS	36" (0.914m)	150gsm	30m	\$27.14 / roll
		BS-PH-150G-42R-NS	42" (1.07m)	150gsm	30m	\$27.14 / roll
		BS-PH-150G-50R-NS	50" (1.27m)	150gsm	30m	\$37.49 / roll
		BS-PH-150G-60R-NS	60" (1.52m)	150gsm	30m	\$44.91 / roll
Glossy Photo Paper (I / D)	BS-PH-180G-NS	BS-PH-180G-24R-NS	24" (0.61m)	180gsm	30m	\$17.94 / roll
		BS-PH-180G-36R-NS	36" (0.914m)	180gsm	30m	\$27.14 / roll
		BS-PH-180G-42R-NS	42" (1.07m)	180gsm	30m	\$31.67 / roll
		BS-PH-180G-50R-NS	50" (1.27m)	180gsm	30m	\$37.49 / roll
		BS-PH-180G-60R-NS	60" (1.52m)	180gsm	30m	\$44.91 / roll
Glossy Photo Paper (I / D)	BS-PH-220G-NS	BS-PH-220G-24R-NS	24" (0.61m)	220gsm	30m	\$21 / roll
		BS-PH-220G-36R-NS	36" (0.914m)	220gsm	30m	\$31.51 / roll
		BS-PH-220G-42R-NS	42" (1.07m)	220gsm	30m	\$36.84 / roll
		BS-PH-220G-50R-NS	50" (1.27m)	220gsm	30m	\$43.95 / roll
Matte Photo Paper (I / D)	BS-PH-150S-NS	BS-PH-150S-24R-NS	24" (0.61m)	150gsm	30m	\$17.94 / roll
		BS-PH-150S-36R-NS	36" (0.914m)	150gsm	30m	\$27.14 / roll
		BS-PH-150S-42R-NS	42" (1.07m)	150gsm	30m	\$31.67 / roll
		BS-PH-150S-50R-NS	50" (1.27m)	150gsm	30m	\$37.49 / roll
		BS-PH-150S-60R-NS	60" (1.52m)	150gsm	30m	\$44.91 / roll
Matte Photo Paper (I / D)	BS-PH-180S-NS	BS-PH-180S-24R-NS	24" (0.61m)	180gsm	30m	\$17.94 / roll
		BS-PH-180S-36R-NS	36" (0.914m)	180gsm	30m	\$27.14 / roll
		BS-PH-180S-42R-NS	42" (1.07m)	180gsm	30m	\$31.67 / roll
		BS-PH-180S-50R-NS	50" (1.27m)	180gsm	30m	\$37.49 / roll
Matte Photo Paper (I / D)	BS-PH-220S-NS	BS-PH-220S-24R-NS	24" (0.61m)	220gsm	30m	\$21 / roll
		BS-PH-220S-36R-NS	36" (0.914m)	220gsm	30m	\$31.51 / roll
		BS-PH-220S-42R-NS	42" (1.07m)	220gsm	30m	\$36.84 / roll
		BS-PH-220S-50R-NS	50" (1.27m)	220gsm	30m	\$43.95 / roll
		BS-PH-220S-60R-NS	60" (1.52m)	220gsm	30m	\$52.35 / roll
Glossy Photo Paper S / A (I / D)	BS-PH-150GL-NS	BS-PH-150GL-36R-NS	36" (0.914m)	150gsm	30m	\$35.87 / roll
		BS-PH-150GL-42R-NS	42" (1.07m)	150gsm	30m	\$42.01 / roll
		BS-PH-150GL-50R-NS	50" (1.27m)	150gsm	30m	\$49.93 / roll
		BS-PH-150GL-60R-NS	60" (1.52m)	150gsm	30m	\$59.78 / roll
		BS-BC-100GL-60R-NS	60" (1.52m)	100µm	30m	\$110.8 / roll

## PET Inkjet Film

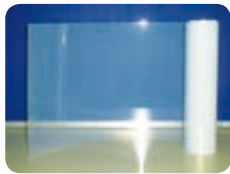

This is a backlit PET film especially for indoor water - based ink. Since we adopted the nanotechnology and selected the transparent PET, the material is shape - keeping. The transmission is even and soft. Appearance of picture is fine and smooth. Colors are bright. Therefore it's widely used for indoor & outdoor light boxes, show windows, and manufacturing of background in studios.

**Media Width:** 24" / 36" / 42" / 50" / 60" (0.61m / 0.914m / 1.07m / 1.27m / 1.52m)

**Media Length:** 30m per roll

**Suitable Inkjet Printers:** Mutoh, Roland, HP, Epson, Mimaki, Encad, etc.

**Suitable Inks:** Pigment ink

**About Price:** The price of advertising material products list on this book is the third ladder price. You can visit our website [www.sign-in-china.com](http://www.sign-in-china.com) for reference.

### ▼ Samples

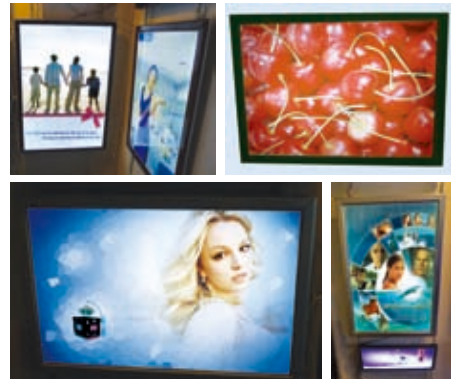

### ▼ Specifications (Quotation according to sq. m) 30m / roll

Name	Series	Thickness	Width	Price
Transparent PET Film	BS-TPET100-XG	100µm	36" / 42" / 50" (0.914m / 1.07m / 1.27m )	\$1.49 / sq. m
	BS-TPET100-60-XG	100µm	60" (1.52m)	\$1.65 / sq. m
PET Negative Backlit Print Film (100µ)	BS-PET100-XG	100µm	36" / 42" / 50" (0.914m / 1.07m / 1.27m )	\$1.49 / sq. m
	BS-PET100-54-XG	100µm	50" / 60" (1.27m / 1.52m)	\$1.65 / sq. m
	BS-PET100-62-XG	100µm	62" / 63" (1.57m / 1.6m)	\$1.65 / sq. m
PET Negative Backlit Print Film (125µ)	BS-PET125-XG	125µm	24" / 36" / 42" / 50" (0.61m / 0.914m / 1.07m / 1.27m)	\$1.98 / sq. m
	BS-PET125-60-XG	125µm	60" / 61" (1.52m / 1.54)	\$2.14 / sq. m
PET Negative Backlit Print Film (175µ)	BS-PET175-XG	175µm	24" / 36" / 42" / 50" (0.61m / 0.914m / 1.07m / 1.27m)	\$2.80 / sq. m
	BS-PET175-60-XG	175µm	60" (1.52m)	\$2.96 / sq. m
Plate Making of Inkjet Film	BS-ZPET100-XG	100µm	24" / 36" / 42" / 50" (0.61m / 0.914m / 1.07m / 1.27m)	\$1.49 / sq. m
	BS-ZPET100-50-XG	100µm	50" / 60" (1.27m / 1.52m)	\$1.65 / sq. m

### ▼ Specifications (Quotation according to roll)

Name	Series	Code	Width	Thickness	Length / roll	MOQ	Price
PET Transparent Film	BS-TPET100-60-XG	BS-TPET100-60R-XG	60" (1.52m)	100µm	30m	32	\$75.13 / roll
PET Transparent Film	BS-TPET100-XG	BS-TPET100-24R-XG	24" (0.61m)	100µm	30m	30	\$27.14 / roll
		BS-TPET100-36R-XG	36" (0.914m)	100µm	30m	30	\$40.72 / roll
		BS-TPET100-42R-XG	42" (1.07m)	100µm	30m	30	\$47.66 / roll
		BS-TPET100-50R-XG	50" (1.27m)	100µm	30m	30	\$56.55 / roll
		BS-PET100-24R-XG	24" (0.61m)	100µm	30m	30	\$27.14 / roll
PET Negative Backlit Print Film (100µ)	BS-PET100-XG	BS-PET100-36R-XG	36" (0.914m)	100µm	30m	30	\$40.72 / roll
		BS-PET100-42R-XG	42" (1.07m)	100µm	30m	30	\$47.66 / roll
		BS-PET100-50R-XG	50" (1.27m)	100µm	30m	30	\$56.56 / roll
PET Negative Backlit Print Film (100µ)	BS-PET100-54-XG	BS-PET100-54R-XG	54" (1.37m)	100µm	30m	32	\$67.86 / roll
		BS-PET100-60R-XG	60" (1.52m)	100µm	30m	32	\$75.13 / roll
PET Negative Backlit Print Film (100µ)	BS-PET100-62-XG	BS-PET100-62R-XG	62" (1.57m)	100µm	30m	32	\$77.55 / roll
		BS-PET100-63R-XG	63" (1.60m)	100µm	30m	32	\$79.17 / roll
PET Negative Backlit Print Film (125µ)	BS-PET125-XG	BS-PET125-24R-XG	24" (0.61m)	125µm	30m	30	\$36.19 / roll
		BS-PET125-36R-XG	36" (0.914m)	125µm	30m	30	\$54.13 / roll
		BS-PET125-42R-XG	42" (1.07m)	125µm	30m	30	\$63.33 / roll
		BS-PET125-50R-XG	50" (1.27m)	125µm	30m	30	\$75.13 / roll
PET Negative Backlit Print Film (125µ)	BS-PET125-60-XG	BS-PET125-60R-XG	60" (1.52m)	125µm	30m	32	\$97.59 / roll
		BS-PET125-61R-XG	61" (1.55m)	125µm	30m	32	\$99.37 / roll
PET Negative Backlit Print Film (175µ)	BS-PET175-XG	BS-PET175-24R-XG	36" (0.914m)	175µm	30m	30	\$49.26 / roll
		BS-PET175-36R-XG	42" (1.07m)	175µm	30m	30	\$76.75 / roll
		BS-PET175-42R-XG	50" (1.27m)	175µm	30m	30	\$89.84 / roll
PET Negative Backlit Print Film (175µ)	BS-PET175-60-XG	BS-PET175-60R-XG	60" (1.52m)	175µm	30m	32	\$135.7 / roll
Plate Making of Inkjet Film	BS-ZPET100-XG	BS-ZPET100-24R-XG	24" (0.61m)	100µm	30m	30	\$27.14 / roll
		BS-ZPET100-36R-XG	36" (0.914m)	100µm	30m	30	\$40.72 / roll
		BS-ZPET100-42R-XG	42" (1.07m)	100µm	30m	30	\$47.66 / roll
Plate Making of Inkjet Film	BS-ZPET100-50-XG	BS-ZPET100-50R-XG	50" (1.27m)	100µm	30m	32	\$62.69 / roll
		BS-ZPET100-60R-XG	60" (1.52m)	100µm	30m	32	\$75.13 / roll

## Matte Water - proof Media

Including self - adhesive vinyl for vehicles, PET film, PP paper, etc.

Because of the waterproof coating, so it is well protected from the sunshine, no fading when putting outside.

Suitable for Mutoh, Roland, HP, Epson, Mimaki printers.

It is widely used for making posters, fleet graphics and wraps, window displays, billboards, etc.

**Media Width:** 36" / 42" / 50" / 60" (0.914m / 1.07m / 1.27m / 1.52m)

**Media Length:** 30m per roll

**Suitable Inkjet Printers:** Mutoh, Roland, HP, Epson, Mimaki, Encad, etc.

**Suitable Inks:** Pigment or dye ink

**About Price:** The price of advertising material products list on this book is the third ladder price. You can visit our website [www.sign-in-china.com](http://www.sign-in-china.com) for reference.



Matte W / R Front  
Print Backlit Film



W / R Matte PP Film  
S / A



W / R Matte PP Film

### ▼ Samples



### ▼ Specifications (Quotation according to sq. m)

Name	Series	Thickness	Width	Price
Matte W / R PVC Vinyl S / A (PET Liner)	BS-BC-100ML-NS	100µm	36" / 42" / 50" / 60" (0.914m / 1.07m / 1.27m / 1.52m)	\$2.13 / sq. m
Matte W / R PVC Vinyl S / A (Paper Liner)	BS-BC-100MP-NS	100µm	336" / 42" / 50" / 60" (0.914m / 1.07m / 1.27m / 1.52m)	\$2.31 / sq. m
Matte W / R PVC Vinyl Gray Adhesive	BS-BC-100MBL-NS	100µm	36" / 42" / 50" / 60" (0.914m / 1.07m / 1.27m / 1.52m)	\$2.31 / sq. m
W / R Matte PP Film S / A	BS-120ML-NS	120µm	36" / 42" / 50" / 60" (0.914m / 1.07m / 1.27m / 1.52m)	\$1.65 / sq. m
W / R PP Film Gray Adhesive	BS-120MBL-NS	120µm	36" / 42" / 50" / 60" (0.914m / 1.07m / 1.27m / 1.52m)	\$2.13 / sq. m
W / R Matte PP Film / Paper	BS-150M-NS	150µm	36" / 42" / 50" / 60" (0.914m / 1.07m / 1.27m / 1.52m)	\$1.48 / sq. m
	BS-180M-NS	180µm	36" / 42" / 50" / 60" (0.914m / 1.07m / 1.27m / 1.52m)	\$1.49 / sq. m
Matte W / R Front Print Backlit Film	BS-FB-110M-NS	110µm	36" / 42" / 50" / 60" (0.914m / 1.07m / 1.27m / 1.52m)	\$1.65 / sq. m
	BS-FB-210M-NS	210µm	36" / 42" / 50" / 60" (0.914m / 1.07m / 1.27m / 1.52m)	\$2.80 / sq. m
	BS-FB-110ML-NS	110µm	36" / 42" / 50" / 60" (0.914m / 1.07m / 1.27m / 1.52m)	\$2.14 / sq. m
	BS-TF-100M-NS	100µm	36" / 42" / 50" / 60" (0.914m / 1.07m / 1.27m / 1.52m)	\$2.13 / sq. m
	BS-TF-200M-NS	200µm	36" / 42" / 50" / 60" (0.914m / 1.07m / 1.27m / 1.52m)	\$2.80 / sq. m
Matte Water - proof Grey Back PET	BS-TF-125MB-NS	125µm	36" / 42" / 50" / 60" (0.914m / 1.07m / 1.27m / 1.52m)	\$2.31 / sq. m
	BS-TF-175MB-NS	175µm	36" / 42" / 50" / 60" (0.914m / 1.07m / 1.27m / 1.52m)	\$2.80 / sq. m

### ▼ Specifications (Quotation according to roll)

Name	Series	Code	Width	Thickness	Length / roll	Price
Matte W / R PVC Vinyl S / A (PET Liner)	BS-BC-100ML-NS	BS-BC-100ML-36R-NS	36" (0.914m)	100µm	30m	\$58.49 / roll
		BS-BC-100ML-42R-NS	42" (1.07m)	100µm	30m	\$68.51 / roll
		BS-BC-100ML-50R-NS	50" (1.27m)	100µm	30m	\$73.29 / roll
		BS-BC-100ML-60R-NS	60" (1.52m)	100µm	30m	\$97.43 / roll
Matte W / R PVC Vinyl S / A (Paper Liner)	BS-BC-100MP-NS	BS-BC-100MP-36R-NS	36" (0.914m)	100µm	30m	\$63.33 / roll
		BS-BC-100MP-42R-NS	42" (1.07m)	100µm	30m	\$74.16 / roll
		BS-BC-100MP-50R-NS	50" (1.27m)	100µm	30m	\$88.06 / roll
		BS-BC-100MP-60R-NS	60" (1.52m)	100µm	30m	\$105.34 / roll

## &gt; Materials and Inks &gt; Indoor inkjet media &gt; matte water - proof media

Name	Series	Code	Width	Thickness	Length / roll	Price
Matte W / R PVC Vinyl Gray Adhesive	BS-BC-100MBL-NS	BS-BC-100MBL-36R-NS	36" (0.914m)	100µm	30m	\$63.33 / roll
		BS-BC-100MBL-42R-NS	42" (1.07m)	100µm	30m	\$74.16 / roll
		BS-BC-100MBL-50R-NS	50" (1.27m)	100µm	30m	\$88.06 / roll
		BS-BC-100MBL-60R-NS	60" (1.52m)	100µm	30m	\$105.34 / roll
W / R Matte PP Film S / A	BS-120ML-NS	BS-120ML-36R-NS	36" (0.914m)	120µm	30m	\$45.24 / roll
		BS-120ML-42R-NS	42" (1.07m)	120µm	30m	\$52.84 / roll
		BS-120ML-50R-NS	50" (1.27m)	120µm	30m	\$62.69 / roll
		BS-120ML-60R-NS	60" (1.52m)	120µm	30m	\$75.13 / roll
W / R PP Film S / A Gray Adhesive	BS-120MBL-NS	BS-120MBL-36R-NS	36" (0.914m)	120µm	30m	\$58.49 / roll
		BS-120MBL-42R-NS	42" (1.07m)	120µm	30m	\$68.51 / roll
		BS-120MBL-50R-NS	50" (1.27m)	120µm	30m	\$81.43 / roll
		BS-120MBL-60R-NS	60" (1.52m)	120µm	30m	\$97.43 / roll
W / R Matte PP Film / Paper	BS-150M-NS	BS-150M-36R-NS	36" (0.914m)	150µm	30m	\$35.87 / roll
		BS-150M-42R-NS	42" (1.07m)	150µm	30m	\$47.66 / roll
		BS-150M-50R-NS	50" (1.27m)	150µm	30m	\$49.93 / roll
		BS-150M-60R-NS	60" (1.52m)	150µm	30m	\$59.78 / roll
W / R Matte PP Film / Paper	BS-180M-NS	BS-180M-36R-NS	36" (0.914m)	180µm	30m	\$40 / roll
		BS-180M-42R-NS	42" (1.07m)	180µm	30m	\$42.01 / roll
		BS-180M-50R-NS	50" (1.27m)	180µm	30m	\$56.55 / roll
		BS-180M-60R-NS	60" (1.52m)	180µm	30m	\$67.86 / roll
Matte W / R Front Print Backlit Film	BS-FB-110M-NS	BS-FB-110M-36R-NS	36" (0.914m)	110µm	30m	\$45.24 / roll
		BS-FB-110M-42R-NS	42" (1.07m)	110µm	30m	\$52.84 / roll
		BS-FB-110M-50R-NS	50" (1.27m)	110µm	30m	\$62.69 / roll
		BS-FB-110M-60R-NS	60" (1.52m)	110µm	30m	\$75.13 / roll
Matte W / R Front Print Backlit Film	BS-FB-210M-NS	BS-FB-210M-36R-NS	36" (0.914m)	210µm	30m	\$76.75 / roll
		BS-FB-210M-42R-NS	42" (1.07m)	210µm	30m	\$89.84 / roll
		BS-FB-210M-50R-NS	50" (1.27m)	210µm	30m	\$106.63 / roll
		BS-FB-210M-60R-NS	60" (1.52m)	210µm	30m	\$127.64 / roll
Matte W / R Front Print Backlit Film	BS-FB-110ML-NS	BS-FB-110ML-36R-NS	36" (0.914m)	110µm	30m	\$58.49 / roll
		BS-FB-110ML-42R-NS	42" (1.07m)	110µm	30m	\$68.51 / roll
		BS-FB-110ML-50R-NS	50" (1.27m)	110µm	30m	\$81.43 / roll
		BS-FB-110ML-60R-NS	60" (1.52m)	110µm	30m	\$97.43 / roll
Matte W / R Front Print Backlit Film	BS-TF-100M-NS	BS-TF-100M-36R-NS	36" (0.914m)	100µm	30m	\$58.49 / roll
		BS-TF-100M-42R-NS	42" (1.07m)	100µm	30m	\$68.51 / roll
		BS-TF-100M-50R-NS	50" (1.27m)	100µm	30m	\$81.43 / roll
		BS-TF-100M-60R-NS	60" (1.52m)	100µm	30m	\$97.43 / roll
Matte W / R Front Print Backlit Film	BS-TF-200M-NS	BS-TF-200M-36R-NS	36" (0.914m)	200µm	30m	\$76.75 / roll
		BS-TF-200M-50R-NS	50" (1.27m)	200µm	30m	\$106.63 / roll
		BS-TF-200M-60R-NS	60" (1.52m)	200µm	30m	\$127.64 / roll
Matte Water - proof Grey Back PET	BS-TF-125MB-NS	BS-TF-125MB-36R-NS	36" (0.914m)	125µm	30m	\$63.33 / roll
		BS-TF-125MB-42R-NS	42" (1.07m)	125µm	30m	\$74.16 / roll
		BS-TF-125MB-50R-NS	50" (1.27m)	125µm	30m	\$88.06 / roll
		BS-TF-125MB-60R-NS	60" (1.52m)	125µm	30m	\$105.34 / roll
Matte Water - proof Grey Back PET	BS-TF-175MB-NS	BS-TF-175MB-36R-NS	36" (0.914m)	175µm	30m	\$76.75 / roll
		BS-TF-175MB-42R-NS	42" (1.07m)	175µm	30m	\$89.84 / roll
		BS-TF-175MB-50R-NS	50" (1.27m)	175µm	30m	\$106.63 / roll
		BS-TF-175MB-60R-NS	60" (1.52m)	175µm	30m	\$127.64 / roll



## Inkjet Canvas (Glossy, Matte)

**Media Width:** 36" / 42" / 50" / 60" (0.914m / 1.07m / 1.27m / 1.52m)

**Media Length:** 18m or 30m per roll

**Suitable Inkjet Printers:** Mutoh, Roland, HP, Epson, Mimaki, Encad, etc.

**Suitable Inks:** Pigment ink

### ▼ Samples



- The inkjet flex & banner, indoor used.
- The colors are highly saturated and distinct.
- People usually need several square meters to print a picture.
- Inkjet flex is packed in rolls.
- Usually, printed by printing equipment with high resolution like Novajet, Roland, Mimaki, HP, Mutoh, etc.
- With a width less than 1.5 meters and a length of 3 - 55 meters, shown as posters and advertisement in marketplaces, exhibition fairs, etc.
- Based on different weave methods, this product is divided into many different varieties for different hanging images, such as Rolla screen, X - stand, L - stand, flag poster, pop up display, etc. Some are for simulation paintings.

**About Price:** The price of advertising material products list on this book is the third ladder price.

You can visit our website [www.sign-in-china.com](http://www.sign-in-china.com) for reference.

### ▼ Specifications (Quotation according to sq. m)

Name	Series	Thickness	Width	Length / roll	Price
Solvent Cotton Canvas	BS-CY-030	320µm	24" / 36" / 42" / 50" / 60" (0.61m / 0.914m / 1.07m / 1.27m / 1.52m)	18m	\$3.24 / sq. m
Solvent Oil Canvas	BS-CY-017S	220µm	24" / 36" / 42" / 50" / 60" (0.61m / 0.914m / 1.07m / 1.27m / 1.52m)	18m	\$1.78 / sq. m
Cotton Canvas	BS-CY-010	250µm	24" / 36" / 42" / 50" / 60" (0.61m / 0.914m / 1.07m / 1.27m / 1.52m)	18m	\$2.75 / sq. m
Cotton Canvas - AW	BS-CY-025W	250µm	24" / 36" / 42" / 50" / 60" (0.61m / 0.914m / 1.07m / 1.27m / 1.52m)	18m	\$3.24 / sq. m
Oil Canvas	BS-CY-006B	210µm	24" / 36" / 42" / 50" / 60" (0.61m / 0.914m / 1.07m / 1.27m / 1.52m)	18m	\$1.62 / sq. m
Cotton Canvas - AN	BS-CY-025N	380µm	24" / 36" / 42" / 50" / 60" (0.61m / 0.914m / 1.07m / 1.27m / 1.52m)	18m	\$3.56 / sq. m
Glossy Cotton Canvas	BS-CY-020W	360µm	24" / 36" / 42" / 50" / 60" (0.61m / 0.914m / 1.07m / 1.27m / 1.52m)	18m	\$3.24 / sq. m
Glossy Cotton Canvas	BS-CY-020N	380µm	24" / 36" / 42" / 50" / 60" (0.61m / 0.914m / 1.07m / 1.27m / 1.52m)	18m	\$3.56 / sq. m
White Canvas - 1	BS-CY-004	110µm	24" / 36" / 42" / 50" / 60" (0.61m / 0.914m / 1.07m / 1.27m / 1.52m)	30m	\$1.46 / sq. m
Polychrome Oil Canvas	BS-CY-008	320µm	24" / 36" / 42" / 50" / 60" (0.61m / 0.914m / 1.07m / 1.27m / 1.52m)	18m	\$2.10 / sq. m
Double side Canvas	BS-CY-014	270µm	24" / 36" / 42" / 50" / 60" (0.61m / 0.914m / 1.07m / 1.27m / 1.52m)	18m	\$3.07 / sq. m
Glossy Oil Canvas	BS-CY-017B	220µm	24" / 36" / 42" / 50" / 60" (0.61m / 0.914m / 1.07m / 1.27m / 1.52m)	18m	\$1.78 / sq. m
Sail Canvas	BS-CY-005	150µm	24" / 36" / 42" / 50" / 60" (0.61m / 0.914m / 1.07m / 1.27m / 1.52m)	18m	\$1.46 / sq. m
Silk Fabric	BS-CY-018	100µm	24" / 36" / 42" / 50" / 60" (0.61m / 0.914m / 1.07m / 1.27m / 1.52m)	30m	\$1.46 / sq. m
Art Fabric	BS-CY-001	100µm	24" / 36" / 42" / 50" / 60" (0.61m / 0.914m / 1.07m / 1.27m / 1.52m)	30m	\$0.97 / sq. m
White Canvas	BS-CY-003	110µm	24" / 36" / 42" / 50" / 60" (0.61m / 0.914m / 1.07m / 1.27m / 1.52m)	30m	\$1.46 / sq. m
Glossy Rain Fabric	BS-CY-009S	100µm	55" / 59" (1.4m / 1.5m)	30m	\$0.97 / sq. m
Flag Fabric	BS-CY-022	100µm	55" / 59" (1.4m / 1.5m)	30m	\$0.81 / sq. m

### ▼ Specifications (Quotation according to roll)

Name	Series	Code	Width	Weight	Length / roll	Price
Solvent Cotton Canvas	BS-CY-030	BS-CY-030-24R	24" (0.61m)	320gsm	18m	\$35.6 / roll
		BS-CY-030-36R	36" (0.914m)	320gsm	18m	\$52.3 / roll
		BS-CY-030-50R	50" (1.27m)	320gsm	18m	\$74.0 / roll
		BS-CY-030-60R	60" (1.52m)	320gsm	18m	\$88.6 / roll
Solvent Oil Canvas	BS-CY-017S	BS-CY-017S-24R	24" (0.61m)	220gsm	18m	\$19.5 / roll
		BS-CY-017S-36R	36" (0.914m)	220gsm	18m	\$29.3 / roll
		BS-CY-017S-50R	50" (1.27m)	220gsm	18m	\$40.7 / roll
		BS-CY-017S-60R	60" (1.52m)	220gsm	18m	\$48.7 / roll

## &gt; Materials and Inks &gt; Indoor inkjet media &gt; inkjet canvas

Name	Series	Code	Width	Weight	Length / roll	Price
Cotton Canvas	BS-CY-010	BS-CY-010-24R	24" (0.61m)	250gsm	18m	\$30.2 / roll
		BS-CY-010-36R	36" (0.914m)	250gsm	18m	\$45.2 / roll
		BS-CY-010-50R	50" (1.27m)	250gsm	18m	\$62.9 / roll
		BS-CY-010-60R	60" (1.52m)	250gsm	18m	\$75.2 / roll
Cotton Canvas - AW	BS-CY-025W	BS-CY-025W-24R	24" (0.61m)	250gsm	18m	\$35.6 / roll
		BS-CY-025W-36R	36" (0.914m)	250gsm	18m	\$52.3 / roll
		BS-CY-025W-50R	50" (1.27m)	250gsm	18m	\$74.0 / roll
		BS-CY-025W-60R	60" (1.52m)	250gsm	18m	\$88.6 / roll
Oil Canvas	BS-CY-006B	BS-CY-006B-24R	24" (0.61m)	210gsm	18m	\$17.8 / roll
		BS-CY-006B-36R	36" (0.914m)	210gsm	18m	\$26.6 / roll
		BS-CY-006B-50R	50" (1.27m)	210gsm	18m	\$37.0 / roll
		BS-CY-006B-60R	60" (1.52m)	210gsm	18m	\$44.3 / roll
Cotton Canvas - AN	BS-CY-025N	BS-CY-025N-24R	24" (0.61m)	380gsm	18m	\$39.1 / roll
		BS-CY-025N-36R	36" (0.914m)	380gsm	18m	\$58.6 / roll
		BS-CY-025N-50R	50" (1.27m)	380gsm	18m	\$81.4 / roll
		BS-CY-025N-60R	60" (1.52m)	380gsm	18m	\$97.4 / roll
Glossy Cotton Canvas	BS-CY-020W	BS-CY-020W-24R	24" (0.61m)	360gsm	18m	\$35.6 / roll
		BS-CY-020W-36R	36" (0.914m)	360gsm	18m	\$52.3 / roll
		BS-CY-020W-50R	50" (1.27m)	360gsm	18m	\$74.0 / roll
		BS-CY-020W-60R	60" (1.52m)	360gsm	18m	\$88.6 / roll
Glossy Cotton Canvas	BS-CY-020N	BS-CY-020N-24R	24" (0.61m)	380gsm	18m	\$39.1 / roll
		BS-CY-020N-36R	36" (0.914m)	380gsm	18m	\$58.6 / roll
		BS-CY-020N-50R	50" (1.27m)	380gsm	18m	\$81.4 / roll
		BS-CY-020N-60R	60" (1.52m)	380gsm	18m	\$97.4 / roll
White Canvas - 1	BS-CY-004	BS-CY-004-24R	24" (0.61m)	110gsm	18m	\$16.0 / roll
		BS-CY-004-36R	36" (0.914m)	110gsm	18m	\$24.0 / roll
		BS-CY-004-50R	50" (1.27m)	110gsm	18m	\$33.4 / roll
		BS-CY-004-60R	60" (1.52m)	110gsm	18m	\$39.9 / roll
Polychrome Oil Canvas	BS-CY-008	BS-CY-008-24R	24" (0.61m)	320gsm	18m	\$23.1 / roll
		BS-CY-008-36R	36" (0.914m)	320gsm	18m	\$34.5 / roll
		BS-CY-008-50R	50" (1.27m)	320gsm	18m	\$48.0 / roll
		BS-CY-008-60R	60" (1.52m)	320gsm	18m	\$57.5 / roll
Double side Canvas	BS-CY-014	BS-CY-014-24R	24" (0.61m)	270gsm	18m	\$33.7 / roll
		BS-CY-014-36R	36" (0.914m)	270gsm	18m	\$50.5 / roll
		BS-CY-014-50R	50" (1.27m)	270gsm	18m	\$70.2 / roll
		BS-CY-014-60R	60" (1.52m)	270gsm	18m	\$84.0 / roll
Glossy Oil Canvas	BS-CY-017B	BS-CY-017B-24R	24" (0.61m)	220gsm	18m	\$19.5 / roll
		BS-CY-017B-36R	36" (0.914m)	220gsm	18m	\$29.3 / roll
		BS-CY-017B-50R	50" (1.27m)	220gsm	18m	\$40.7 / roll
		BS-CY-017B-60R	60" (1.52m)	220gsm	18m	\$48.7 / roll
Sail Canvas	BS-CY-005	BS-CY-005-24R	24" (0.61m)	150gsm	18m	\$16.0 / roll
		BS-CY-005-36R	36" (0.914m)	150gsm	18m	\$24.0 / roll
		BS-CY-005-50R	50" (1.27m)	150gsm	18m	\$33.4 / roll
		BS-CY-005-60R	60" (1.52m)	150gsm	18m	\$39.9 / roll
Silk Fabric	BS-CY-018	BS-CY-018-24R	24" (0.61m)	100gsm	18m	\$16.0 / roll
		BS-CY-018-36R	36" (0.914m)	100gsm	18m	\$24.0 / roll
		BS-CY-018-50R	50" (1.27m)	100gsm	18m	\$33.4 / roll
		BS-CY-018-60R	60" (1.52m)	100gsm	18m	\$39.9 / roll
Art Fabric	BS-CY-001	BS-CY-001-24R	24" (0.61m)	100gsm	18m	\$10.7 / roll
		BS-CY-001-36R	36" (0.914m)	100gsm	18m	\$16.0 / roll
		BS-CY-001-50R	50" (1.27m)	100gsm	18m	\$22.2 / roll
		BS-CY-001-60R	60" (1.52m)	100gsm	18m	\$26.5 / roll
White Canvas	BS-CY-003	BS-CY-003-24R	24" (0.61m)	110gsm	18m	\$16.0 / roll
		BS-CY-003-36R	36" (0.914m)	110gsm	18m	\$24.0 / roll
		BS-CY-003-50R	50" (1.27m)	110gsm	18m	\$33.4 / roll
		BS-CY-003-60R	60" (1.52m)	110gsm	18m	\$39.9 / roll
Glossy Rain Fabric	BS-CY-009S	BS-CY-009-140R	55" (1.4m)	100gsm	30m	\$40.7 / roll
		BS-CY-009-150R	59" (1.5m)	100gsm	30m	\$43.7 / roll
Flag Fabric	BS-CY-022	BS-CY-022-140R	55" (1.4m)	100gsm	30m	\$34.0 / roll
		BS-CY-022-150R	59" (1.5m)	100gsm	30m	\$36.5 / roll

## Self Adhesive Vinyl Film (Vehicle Wraps)

**Media Width:** 36.8" / 42" / 50" / 60" (0.98m / 1.07m / 1.27m / 1.52m)

**Media Length:** 50m or 100m per roll

Used for the wide format digital printing indoor and outdoor, the ECO solvent printing and screen printing, mainly used in advertising of the windows of the buses, taxis, subway and other means of transport, glass wall advertising, windows of shopping mall advertising.

### ▼ The application of the printer types

**Solvent:** Vutek, Noel, Scitex, DGI, Teckwin, Yaselan, Flora, Fitto, Infinity, GongZheng, LiYu.

**ECO solvent:** Mutoh, Roland, 9.8' (3m), Mimaki and others.

**About Price:** The price of advertising material products list on this book is the third ladder price.

You can visit our website [www.sign-in-china.com](http://www.sign-in-china.com) for reference.

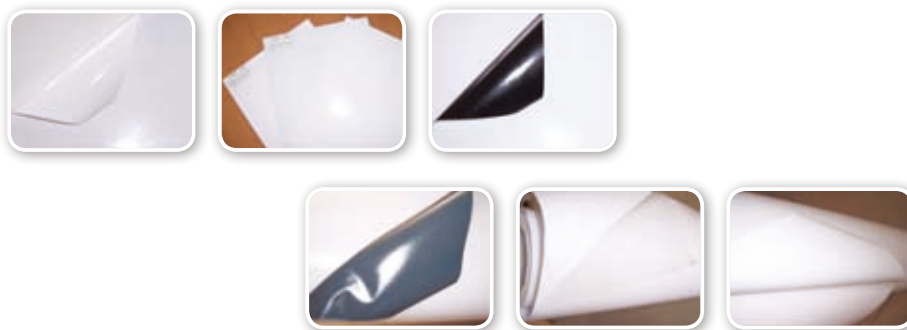
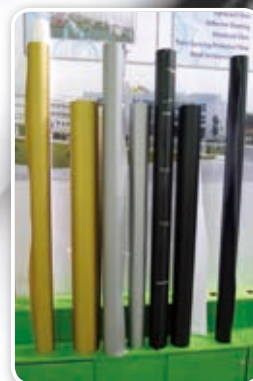

### ▼ Specifications (Quotation according to sq. m) 50m, 100m / roll

Name	Series	Glue	Weight	PVC Face	Width	Price
Self Adhesive Vinyl Film / Vehicle Wrap (One year warranty)	BS-PV350W-PY	Transparent	120gsm	100μm	38.6" / 42" / 50" / 54" / 60" (0.98m / 1.07m / 1.27m / 1.37mm / 1.52m)	\$0.84 / sq. m
	BS-PV350B-PY	Black	120gsm	100μm	38.6" / 42" / 50" / 54" / 60" (0.98m / 1.07m / 1.27m / 1.37mm / 1.52m)	\$0.84 / sq. m
	BS-PV350G-PY	Grey	120gsm	100μm	38.6" / 42" / 50" / 54" / 60" (0.98m / 1.07m / 1.27m / 1.37mm / 1.52m)	\$0.84 / sq. m
Bubble Free Self Adhesive Vinyl Film / Vehicle Wrap (One year warranty)	BS-PV3500W-PY	Transparent	140gsm	100μm	38.6" / 42" / 50" / 54" / 60" (0.98m / 1.07m / 1.27m / 1.37mm / 1.52m)	\$0.98 / sq. m
	BS-PV3500B-PY	Black	140gsm	100μm	38.6" / 42" / 50" / 54" / 60" (0.98m / 1.07m / 1.27m / 1.37mm / 1.52m)	\$0.98 / sq. m
	BS-PV3500G-PY	Grey	140gsm	100μm	38.6" / 42" / 50" / 54" / 60" (0.98m / 1.07m / 1.27m / 1.37mm / 1.52m)	\$0.98 / sq. m
High Quality Self Adhesive Vinyl Film / Vehicle Wrap	BS-SC100-PY	Transparent	160gsm	80μm	38.6" / 42" / 50" / 54" / 60" (0.98m / 1.07m / 1.27m / 1.37mm / 1.52m)	\$1.1 / sq. m
High Quality Bubble Free Self Adhesive Vinyl Film / Vehicle Wrap	BS-SC1000-PY	Transparent	140gsm	80μm	38.6" / 42" / 50" / 54" / 60" (0.98m / 1.07m / 1.27m / 1.37mm / 1.52m)	\$1.16 / sq. m
Self Adhesive Vinyl Film / Vehicle Wrap (Two years warranty)	BS-PL500-PY	Transparent	140gsm	80μm	36" / 42" / 50" / 60" (0.914m / 1.07m / 1.27m / 1.52m)	\$0.88 / sq. m
High Polymer White Glue Self Adhesive Vinyl Film / Vehicle Wrap	BS-PV700W-PY	Transparent	140gsm	80μm	38.6" / 42" / 50" / 54" / 60" (0.98m / 1.07m / 1.27m / 1.37mm / 1.52m)	\$1.37 / sq. m
High Polymer Black Glue Self Adhesive Vinyl Film / Vehicle Wrap	BS-PV700B-PY	Black	140gsm	80μm	38.6" / 42" / 50" / 54" / 60" (0.98m / 1.07m / 1.27m / 1.37mm / 1.52m)	\$1.42 / sq. m
High Polymer Grey Glue Self Adhesive Vinyl Film / Vehicle Wrap	BS-PV700G-PY	Grey	140gsm	80μm	38.6" / 42" / 50" / 54" / 60" (0.98m / 1.07m / 1.27m / 1.37mm / 1.52m)	\$1.42 / sq. m
High Quality Bubble Free White Glue Self Adhesive Vinyl Film / Vehicle Wrap	BS-PV7000W-PY	Transparent	140gsm	80μm	38.6" / 42" / 50" / 54" / 60" (0.98m / 1.07m / 1.27m / 1.37mm / 1.52m)	\$1.42 / sq. m
High Quality Bubble Free Black Glue Self Adhesive Vinyl Film / Vehicle Wrap	BS-PV7000B-PY	Black	140gsm	80μm	38.6" / 42" / 50" / 54" / 60" (0.98m / 1.07m / 1.27m / 1.37mm / 1.52m)	\$1.47 / sq. m
High Quality Bubble Free Grey Glue Self Adhesive Vinyl Film / Vehicle Wrap	BS-PV7000G-PY	Grey	140gsm	80μm	36" / 42" / 50" / 60" (0.914m / 1.07m / 1.27m / 1.52m)	\$1.47 / sq. m

## &gt; Materials and Inks &gt; Outdoor inkjet media &gt; self adhesive vinyl film (vehicle wraps) //

## ▼ Specifications (Quotation according to roll)

Name	Series	Code	Width	Line Weight	PVC Face	Length / roll	Price
White Glue Self Adhesive Vinyl Film / Vehicle Wrap (One year warranty)	BS-PV350W-PY	BS-PV350W-38R-PY	38.6" (0.98m)	120gsm	100µm	50m	\$41.31 / roll
		BS-PV350W-42R-PY	42" (1.07m)	120gsm	100µm	50m	\$45.1 / roll
		BS-PV350W-50R-PY	50" (1.27m)	120gsm	100µm	50m	\$53.53 / roll
		BS-PV350W-54R-PY	54" (1.37m)	120gsm	100µm	50m	\$57.74 / roll
		BS-PV350W-60R-PY	60" (1.52m)	120gsm	100µm	50m	\$64.06 / roll
Black Glue Self Adhesive Vinyl Film / Vehicle Wrap (One year warranty)	BS-PV350B-PY	BS-PV350B-38R-PY	38.6" (0.98m)	120gsm	100µm	50m	\$41.31 / roll
		BS-PV350B-42R-PY	42" (1.07m)	120gsm	100µm	50m	\$45.1 / roll
		BS-PV350B-50R-PY	50" (1.27m)	120gsm	100µm	50m	\$53.53 / roll
		BS-PV350B-54R-PY	54" (1.37m)	120gsm	100µm	50m	\$57.74 / roll
		BS-PV350B-60R-PY	60" (1.52m)	120gsm	100µm	50m	\$64.06 / roll
Grey Glue Self Adhesive Vinyl Film / Vehicle Wrap (One year warranty)	BS-PV350G-PY	BS-PV350G-38R-PY	38.6" (0.98m)	120gsm	100µm	50m	\$41.31 / roll
		BS-PV350G-42R-PY	42" (1.07m)	120gsm	100µm	50m	\$45.1 / roll
		BS-PV350G-50R-PY	50" (1.27m)	120gsm	100µm	50m	\$53.53 / roll
		BS-PV350G-54R-PY	54" (1.37m)	120gsm	100µm	50m	\$57.74 / roll
		BS-PV350G-60R-PY	60" (1.52m)	120gsm	100µm	50m	\$64.06 / roll
Bubble Free White Glue Self Adhesive Vinyl Film / Vehicle Wrap (One year warranty)	BS-PV3500W-PY	BS-PV3500W-38R-PY	38.6" (0.98m)	140gsm	100µm	50m	\$48.19 / roll
		BS-PV3500W-42R-PY	42" (1.07m)	140gsm	100µm	50m	\$52.62 / roll
		BS-PV3500W-50R-PY	50" (1.27m)	140gsm	100µm	50m	\$62.45 / roll
		BS-PV3500W-54R-PY	54" (1.37m)	140gsm	100µm	50m	\$67.37 / roll
		BS-PV3500W-60R-PY	60" (1.52m)	140gsm	100µm	50m	\$74.74 / roll
Bubble Free Black Glue Self Adhesive Vinyl Film / Vehicle Wrap (One year warranty)	BS-PV3500B-PY	BS-PV3500B-38R-PY	38.6" (0.98m)	140gsm	100µm	50m	\$47.09 / roll
		BS-PV3500B-42R-PY	42" (1.07m)	140gsm	100µm	50m	\$51.42 / roll
		BS-PV3500B-50R-PY	50" (1.27m)	140gsm	100µm	50m	\$61.02 / roll
		BS-PV3500B-54R-PY	54" (1.37m)	140gsm	100µm	50m	\$65.82 / roll
		BS-PV3500B-60R-PY	60" (1.52m)	140gsm	100µm	50m	\$73.03 / roll
Bubble Free Grey Glue Self Adhesive Vinyl Film / Vehicle Wrap (One year warranty)	BS-PV3500G-PY	BS-PV3500G-38R-PY	38.6" (0.98m)	140gsm	100µm	50m	\$53.35 / roll
		BS-PV3500G-42R-PY	42" (1.07m)	140gsm	100µm	50m	\$58.25 / roll
		BS-PV3500G-50R-PY	50" (1.27m)	140gsm	100µm	50m	\$69.14 / roll
		BS-PV3500G-54R-PY	54" (1.37m)	140gsm	100µm	50m	\$57.59 / roll
		BS-PV3500G-60R-PY	60" (1.52m)	140gsm	100µm	50m	\$82.76 / roll
High Quality White Glue Self Adhesive Vinyl Film / Vehicle Wrap	BS-SC100-PY	BS-SC100-38R-PY	38.6" (0.98m)	160gsm	80µm	50m	\$53.69 / roll
		BS-SC100-42R-PY	42" (1.07m)	160gsm	80µm	50m	\$58.63 / roll
		BS-SC100-50R-PY	50" (1.27m)	160gsm	80µm	50m	\$69.59 / roll
		BS-SC100-54R-PY	54" (1.37m)	160gsm	80µm	50m	\$75.06 / roll
		BS-SC100-60R-PY	60" (1.52m)	160gsm	80µm	50m	\$83.28 / roll
High Quality Bubble Free White Glue Self Adhesive Vinyl Film / Vehicle Wrap	BS-SC1000-PY	BS-SC1000-38R-PY	38.6" (0.98m)	140gsm	80µm	50m	\$57.00 / roll
		BS-SC1000-42R-PY	42" (1.07m)	140gsm	80µm	50m	\$62.23 / roll
		BS-SC1000-50R-PY	50" (1.27m)	140gsm	80µm	50m	\$73.87 / roll
		BS-SC1000-54R-PY	54" (1.37m)	140gsm	80µm	50m	\$79.69 / roll
		BS-SC1000-60R-PY	60" (1.52m)	140gsm	80µm	50m	\$88.4 / roll
Transparent Self Adhesive Vinyl Film / Vehicle Wrap (Two years warranty)	BS-PL500-PY	BS-PL500-38R-PY	38.6" (0.98m)	140gsm	80µm	50m	\$42.96 / roll
		BS-PL500-42R-PY	42" (1.07m)	140gsm	80µm	50m	\$46.90 / roll
		BS-PL500-50R-PY	50" (1.27m)	140gsm	80µm	50m	\$5.00 / roll
		BS-PL500-54R-PY	54" (1.37m)	140gsm	80µm	50m	\$77.4 / roll
		BS-PL500-60R-PY	60" (1.52m)	140gsm	80µm	50m	\$85.9 / roll
High Polymer White Glue Self Adhesive Vinyl Film / Vehicle Wrap	BS-PV700W-PY	BS-PV700W-38R-PY	38.6" (0.98m)	140gsm	80µm	50m	\$66.91 / roll
		BS-PV700W-42R-PY	42" (1.07m)	140gsm	80µm	50m	\$73.06 / roll
		BS-PV700W-50R-PY	50" (1.27m)	140gsm	80µm	50m	\$86.72 / roll
		BS-PV700W-54R-PY	54" (1.37m)	140gsm	80µm	50m	\$93.54 / roll
		BS-PV700W-60R-PY	60" (1.52m)	140gsm	80µm	50m	\$103.79 / roll

## &gt; Materials and Inks &gt; Outdoor inkjet media &gt; self adhesive vinyl film (vehicle wraps) //

Name	Series	Code	Width	Line Weight	PVC Face	Length / roll	Price
High Polymer Black Glue Self Adhesive Vinyl Film / Vehicle Wrap	BS-PV700B-PY	BS-PV700B-38R-PY	38.6" (0.98m)	140gsm	80μm	50m	\$69.39 / roll
		BS-PV700B-42R-PY	42" (1.07m)	140gsm	80μm	50m	\$75.77 / roll
		BS-PV700B-50R-PY	50" (1.27m)	140gsm	80μm	50m	\$89.93 / roll
		BS-PV700B-54R-PY	54" (1.37m)	140gsm	80μm	50m	\$97.01 / roll
		BS-PV700B-60R-PY	60" (1.52m)	140gsm	80μm	50m	\$107.63 / roll
High Polymer Grey Glue Self Adhesive Vinyl Film / Vehicle Wrap	BS-PV700G-PY	BS-PV700G-38R-PY	38.6" (0.98m)	140gsm	80μm	50m	\$69.39 / roll
		BS-PV700G-42R-PY	42" (1.07m)	140gsm	80μm	50m	\$75.77 / roll
		BS-PV700G-50R-PY	50" (1.27m)	140gsm	80μm	50m	\$89.93 / roll
		BS-PV700G-54R-PY	54" (1.37m)	140gsm	80μm	50m	\$97.01 / roll
		BS-PV700G-60R-PY	60" (1.52m)	140gsm	80μm	50m	\$107.63 / roll
High Quality Bubble Free White Glue Self Adhesive Vinyl Film / Vehicle Wrap	BS-PV7000W-PY	BS-PV7000W-38R-PY	38.6" (0.98m)	140gsm	80μm	50m	\$69.39 / roll
		BS-PV7000W-42R-PY	42" (1.07m)	140gsm	80μm	50m	\$75.77 / roll
		BS-PV7000W-50R-PY	50" (1.27m)	140gsm	80μm	50m	\$89.93 / roll
		BS-PV7000W-54R-PY	54" (1.37m)	140gsm	80μm	50m	\$97.01 / roll
		BS-PV7000W-60R-PY	60" (1.52m)	140gsm	80μm	50m	\$107.63 / roll
High Quality Bubble Free Black Glue Self Adhesive Vinyl Film / Vehicle Wrap	BS-PV7000B-PY	BS-PV7000B-38R-PY	38.6" (0.98m)	140gsm	80μm	50m	\$71.88 / roll
		BS-PV7000B-42R-PY	42" (1.07m)	140gsm	80μm	50m	\$78.47 / roll
		BS-PV7000B-50R-PY	50" (1.27m)	140gsm	80μm	50m	\$93.14 / roll
		BS-PV7000B-54R-PY	54" (1.37m)	140gsm	80μm	50m	\$100.47 / roll
		BS-PV7000B-60R-PY	60" (1.52m)	140gsm	80μm	50m	\$111.48 / roll
High Quality Bubble Free Grey Glue Self Adhesive Vinyl Film / Vehicle Wrap	BS-PV7000G-PY	BS-PV7000G-38R-PY	38.6" (0.98m)	140gsm	80μm	50m	\$71.88 / roll
		BS-PV7000G-42R-PY	42" (1.07m)	140gsm	80μm	50m	\$78.47 / roll
		BS-PV7000G-50R-PY	50" (1.27m)	140gsm	80μm	50m	\$93.14 / roll
		BS-PV7000G-54R-PY	54" (1.37m)	140gsm	80μm	50m	\$100.47 / roll
		BS-PV7000G-60R-PY	60" (1.52m)	140gsm	80μm	50m	\$111.48 / roll
60" (1.52m) High Quality 3D Carbon Fiber Vehicle Wraps	BS-CAQ- DS	BS-CAQ-60R-DS	60" (1.52m)	140gsm	80μm	50m	\$96.94 / roll
54" (1.37m) Print - On - Glue One Way Vision (Transparent)	BS-WYJ7106-SZG	BS-WYJ7106-SZG-54R	54" (1.37m)	140gsm	80μm	50m	\$1,250 / roll
54" (1.37m) Print - On - Glue Self - adhesive Vinyl (Transparent)	BS-WYJ7300-SZG	BS-WYJ7300-SZG-54R	54" (1.37m)	140gsm	80μm	50m	\$962.2 / roll
54" (1.37m) Print - On - Glue Self - adhesive Vinyl (White)	BS-WYJ7200-SZG	BS-WYJ7200-SZG-54R	54" (1.37m)	140gsm	80μm	50m	\$962.2 / roll
60" (1.52m) High Quality Matte Vehicle Wraps	BS-MT- DS	BS-MT-60R-DS	60" (1.52m)	140gsm	80μm	50m	\$96.94 / roll
60" (1.52m) High Quality Vehicle Wraps	BS-MPI3802	BS-MPI3802-60R	60" (1.52m)	140gsm	80μm	50m	\$171.8 / roll

## ▼ Samples



# PVC Flex Banner

**Media Width:** 40" - 126" (1.02m - 3.2m), 138" - 201" (3.51 - 5.10m)

**Media Length:** 50m per roll

Good smoothness, high bonding strength, stable ink absorbing, expressive force, self-cleaning, faster drying, perfect printing ability, anti - UV surface

**Application:** Signage, Digital printing, Screen printing for banner and outdoor, indoor digital printing and so on.

**About Price:** The price of advertising material products list on this book is the third ladder price. You can visit our website [www.sign-in-china.com](http://www.sign-in-china.com) for reference.



## ▼ Specifications (Quotation according to sq. m)

Name	Series	Weight	Substrates	Width	Price
Laminated Backlit	BS-LB001-GL	480gsm	300 x 500 18 x 12	40" - 126" (1.02m - 3.2m)	\$1.13 / sq. m
Laminated Backlit	BS-LB002-GL	610gsm	300 x 500 18 x 12	40" - 126" (1.02m - 3.2m)	\$1.29 / sq. m
Laminated Backlit	BS-LB003-GL	630gsm	500 x 500 18 x 12	40" - 126" (1.02m - 3.2m)	\$1.45 / sq. m
Laminated Backlit	BS-LB004-GL	650gsm	300 x 1000 18 x 12	40" - 126" (1.02m - 3.2m)	\$1.45 / sq. m
Coated Backlit	BS-CB005-GL-1	440gsm	250 x 250 36 x 36	40" - 126" (1.02m - 3.2m)	\$2.26 / sq. m
Coated Backlit	BS-CB005-GL-G	510gsm	1000 x 1000 20 x 20	40" - 126" (1.02m - 3.2m)	\$2.26 / sq. m
Coated Backlit	BS-CB005-GL-2-M	610gsm	1000 x 1000 20 x 20	40" - 126" (1.02m - 3.2m)	\$2.30 / sq. m
Laminated Frontlit	BS-LF006-1-GL-G	280gsm	200 x 300 18 x 12	40" - 126" (1.02m - 3.2m)	\$0.65 / sq. m
Laminated Frontlit	BS-LF006-GL-G	300gsm	200 x 300 18 x 12	40" - 126" (1.02m - 3.2m)	\$0.65 / sq. m
Laminated Frontlit	BS-LF007-1-GL-G	320gsm	200 x 300 18 x 12	40" - 126" (1.02m - 3.2m)	\$0.65 / sq. m
Laminated Frontlit	BS-LF007-GL-G	340gsm	200 x 300 18 x 12	40" - 126" (1.02m - 3.2m)	\$0.75 / sq. m
Laminated Frontlit	BS-LF008-GL	380gsm	300 x 500 18 x 12	40" - 126" (1.02m - 3.2m)	\$0.81 / sq. m
Laminated Frontlit	BS-LF009-GL-G	440gsm	300 x 500 18 x 12	40" - 126" (1.02m - 3.2m)	\$0.97 / sq. m
Laminated Frontlit	BS-LF009-GL-M	440gsm	300 x 500 18 x 12	40" - 126" (1.02m - 3.2m)	\$0.97 / sq. m
Laminated Frontlit	BS-LF009-GL-W / G	440gsm	300 x 500 18 x 12	40" - 126" (1.02m - 3.2m)	\$0.97 / sq. m
Laminated Frontlit	BS-LF009-GL-W / B	440gsm	300 x 500 18 x 12	40" - 126" (1.02m - 3.2m)	\$0.97 / sq. m
Laminated Frontlit	BS-LF010-GL-G	440gsm	500 x 500 18 x 12	40" - 126" (1.02m - 3.2m)	\$0.97 / sq. m
Laminated Frontlit	BS-LF010-GL-M	440gsm	500 x 500 18 x 12	40" - 126" (1.02m - 3.2m)	\$0.97 / sq. m
Laminated Frontlit	BS-LF010-GL-W / G	440gsm	500 x 500 18 x 12	40" - 126" (1.02m - 3.2m)	\$0.97 / sq. m
Laminated Frontlit	BS-LF010-GL-W / B	440gsm	500 x 500 18 x 12	40" - 126" (1.02m - 3.2m)	\$0.97 / sq. m
Laminated Frontlit	BS-LF011-GL-G	440gsm	1000 x 1000 9 x 9	40" - 126" (1.02m - 3.2m)	\$1.13 / sq. m
Laminated Frontlit	BS-LF011-GL-M	440gsm	1000 x 1000 9 x 9	40" - 126" (1.02m - 3.2m)	\$1.13 / sq. m
Laminated Frontlit	BS-LF011-GL-W / G	440gsm	1000 x 1000 9 x 9	40" - 126" (1.02m - 3.2m)	\$1.13 / sq. m
Laminated Frontlit	BS-LF011-GL-W / B	440gsm	1000 x 1000 9 x 9	40" - 126" (1.02m - 3.2m)	\$1.13 / sq. m
Laminated Frontlit	BS-LF011-1-GL-G	510gsm	1000 x 1000 9 x 9	40" - 126" (1.02m - 3.2m)	\$1.13 / sq. m
Laminated Frontlit	BS-LF011-1-GL-W / B	510gsm	1000 x 1000 9 x 9	40" - 126" (1.02m - 3.2m)	\$1.13 / sq. m
Laminated Frontlit	BS-LF012-GL	610gsm	1000 x 1000 12 x 12	40" - 126" (1.02m - 3.2m)	\$1.45 / sq. m
Coated Frontlit	BS-CF013-GL	440gsm	500 x 500 28 x 28	40" - 126" (1.02m - 3.2m)	\$1.94 / sq. m
Coated Frontlit	BS-CF013-1-GL	460gsm	1000 x 1000 18 x 18	40" - 126" (1.02m - 3.2m)	\$1.78 / sq. m
Coated Frontlit	BS-CF014-GL	510gsm	1000 x 1000 20 x 20	40" - 126" (1.02m - 3.2m)	\$1.94 / sq. m
Coated Frontlit	BS-CF015-GL	560gsm	1000 x 1000 20 x 20	40" - 126" (1.02m - 3.2m)	\$1.94 / sq. m
Coated Blockout	BS-CF016-GL	440gsm	250 x 250 36 x 36	40" - 126" (1.02m - 3.2m)	\$2.1 / sq. m
Coated Blockout	BS-CF017-GL	610gsm	1000 x 1000 20 x 20	40" - 126" (1.02m - 3.2m)	\$2.42 / sq. m
Backlit Flex Banner	ODP-LB-NHB5050G / M-HLD-1	610gsm	500 x 500 18 x 12	138" - 201" (3.51 - 5.10m)	\$2.58 / sq. m
Backlit Flex Banner	ODP-LB-NHB530G / M-HLD-1	510gsm	300 x 500 18 x 12	138" - 201" (3.51 - 5.10m)	\$2.26 / sq. m
Blockout Flex Banner	ODP-BM-NHT8080M-HLD-1	610gsm	840 x 840 9 x 9	138" - 201" (3.51 - 5.10m)	\$2.42 / sq. m
Frontlit Flex Banner	ODP-FB-NHF8080G / M-HLD-1	440gsm	840 x 840 9 x 9	138" - 201" (3.51 - 5.10m)	\$1.62 / sq. m
Frontlit Flex Banner	ODP-FB-NHF550G / M-HLD-1	440gsm	500 x 500 9 x 9	138" - 201" (3.51 - 5.10m)	\$1.45 / sq. m
Frontlit Flex Banner	ODP-FB-NHF530G / M-HLD-1	440gsm	300 x 500 18 x 12	138" - 201" (3.51 - 5.10m)	\$1.45 / sq. m
Frontlit Flex Banner	ODP-FB-NHF530G / M-HLD-2	510gsm	300 x 500 18 x 12	138" - 201" (3.51 - 5.10m)	\$1.62 / sq. m
Frontlit Flex Banner	ODP-FB-NHF1010G / M-HLD-1	510gsm	1000 x 1000 16 x 16	138" - 201" (3.51 - 5.10m)	\$2.26 / sq. m

## &gt; Materials and Inks &gt; Outdoor inkjet media &gt; PVC flex banner

## ▼ Specifications (Quotation according to roll)

Name	Series	Code	Width	Weight	Substrates	Price
Laminated Backlit	BS-LB001-GL	BS-LB001-40R-GL	40" (1.02m)	480gsm	300 x 500 18 x 12	\$42.89 / roll
		BS-LB001-86R-GL	86.6" (2.2m)	480gsm	300 x 500 18 x 12	\$92.51 / roll
		BS-LB001-98R-GL	98.4" (2.5m)	480gsm	300 x 500 18 x 12	\$105.12 / roll
		BS-LB001-110R-GL	110" (2.8m)	480gsm	300 x 500 18 x 12	\$117.74 / roll
		BS-LB001-125R-GL	126" (3.2m)	480gsm	300 x 500 18 x 12	\$134.56 / roll
Laminated Backlit	BS-LB002-GL	BS-LB002-40R-GL	40" (1.02m)	610gsm	300 x 500 18 x 12	\$54.22 / roll
		BS-LB002-86R-GL	86.6" (2.2m)	610gsm	300 x 500 18 x 12	\$116.94 / roll
		BS-LB002-98R-GL	98.4" (2.5m)	610gsm	300 x 500 18 x 12	\$132.9 / roll
		BS-LB002-110R-GL	110" (2.8m)	610gsm	300 x 500 18 x 12	\$148.84 / roll
		BS-LB002-125R-GL	126" (3.2m)	610gsm	300 x 500 18 x 12	\$170.1 / roll
Laminated Backlit	BS-LB003-GL	BS-LB003-40R-GL	40" (1.02m)	630gsm	500 x 500 18 x 12	\$61.5 / roll
		BS-LB003-86R-GL	86.6" (2.2m)	630gsm	500 x 500 18 x 12	\$132.66 / roll
		BS-LB003-98R-GL	98.4" (2.5m)	630gsm	500 x 500 18 x 12	\$150.74 / roll
		BS-LB003-110R-GL	110.2" (2.8m)	630gsm	500 x 500 18 x 12	\$168.83 / roll
		BS-LB003-125R-GL	125.9" (3.2m)	630gsm	500 x 500 18 x 12	\$192.95 / roll
Laminated Backlit	BS-LB004-GL	BS-LB004-40R-GL	40" (1.02m)	650gsm	300 x 1000 18 x 12	\$63.12 / roll
		BS-LB004-86R-GL	86.6" (2.2m)	650gsm	300 x 1000 18 x 12	\$136.14 / roll
		BS-LB004-98R-GL	98.4" (2.5m)	650gsm	300 x 1000 18 x 12	\$154.71 / roll
		BS-LB004-110R-GL	110" (2.8m)	650gsm	300 x 1000 18 x 12	\$173.28 / roll
		BS-LB004-125R-GL	125.9" (3.2m)	650gsm	300 x 1000 18 x 12	\$198.03 / roll
Coated Backlit	BS-CB005-GL-1	BS-CB005-40R-GL-1	40" (1.02m)	440gsm	250 x 250 36 x 36	\$76.07 / roll
		BS-CB005-86R-GL-1	86.6" (2.2m)	440gsm	250 x 250 36 x 36	\$164.07 / roll
		BS-CB005-98R-GL-1	98.4" (2.5m)	440gsm	250 x 250 36 x 36	\$186.45 / roll
		BS-CB005-110R-GL-1	110" (2.8m)	440gsm	250 x 250 36 x 36	\$208.82 / roll
		BS-CB005-125R-GL-1	125.9" (3.2m)	440gsm	250 x 250 36 x 36	\$238.65 / roll
Coated Backlit	BS-CB005-GL-G	BS-CB005-40R-GL-G	40" (1.02m)	510gsm	1000 x 1000 20 x 20	\$76.88 / roll
		BS-CB005-86R-GL-G	86.6" (2.2m)	510gsm	1000 x 1000 20 x 20	\$165.82 / roll
		BS-CB005-98R-GL-G	98.4" (2.5m)	510gsm	1000 x 1000 20 x 20	\$188.43 / roll
		BS-CB005-110R-GL-G	110" (2.8m)	510gsm	1000 x 1000 20 x 20	\$211.04 / roll
		BS-CB005-125R-GL-G	125.9" (3.2m)	510gsm	1000 x 1000 20 x 20	\$240.80 / roll
Coated Backlit	BS-CB005-GL-2-M	BS-CB005-40R-GL-2-M	40" (1.02m)	610gsm	1000 x 1000 20 x 20	\$80.52 / roll
		BS-CB005-86R-GL-2-M	86.6" (2.2m)	610gsm	1000 x 1000 20 x 20	\$173.67 / roll
		BS-CB005-98R-GL-2-M	98.4" (2.5m)	610gsm	1000 x 1000 20 x 20	\$197.35 / roll
		BS-CB005-110R-GL-2-M	110" (2.8m)	610gsm	1000 x 1000 20 x 20	\$221.04 / roll
		BS-CB005-125R-GL-2-M	125.9" (3.2m)	610gsm	1000 x 1000 20 x 20	\$252 / roll
Laminated Frontlit	BS-LF006-1-GL-G	BS-LF006-40R-1-GL-G	40" (1.02m)	280gsm	200 x 300 18 x 12	\$26.70 / roll
		BS-LF006-86R-1-GL-G	86.6" (2.2m)	280gsm	200 x 300 18 x 12	\$57.60 / roll
		BS-LF006-98R-1-GL-G	98.4" (2.5m)	280gsm	200 x 300 18 x 12	\$65.46 / roll
		BS-LF006-110R-1-GL-G	110" (2.8m)	280gsm	200 x 300 18 x 12	\$73.31 / roll
		BS-LF006-125R-1-GL-G	125.9" (3.2m)	280gsm	200 x 300 18 x 12	\$83.78 / roll
Laminated Frontlit	BS-LF006-GL-G	BS-LF006-40R-GL-G	40" (1.02m)	300gsm	200 x 300 18 x 12	\$28.32 / roll
		BS-LF006-86R-GL-G	86.6" (2.2m)	300gsm	200 x 300 18 x 12	\$61.09 / roll
		BS-LF006-98R-GL-G	98.4" (2.5m)	300gsm	200 x 300 18 x 12	\$69.42 / roll
		BS-LF006-110R-GL-G	110" (2.8m)	300gsm	200 x 300 18 x 12	\$77.75 / roll
		BS-LF006-125R-GL-G	125.9" (3.2m)	300gsm	200 x 300 18 x 12	\$88.86 / roll
Laminated Frontlit	BS-LF007-1-GL-G	BS-LF007-40R-1-GL-G	40" (1.02m)	320gsm	200 x 300 18 x 12	\$29.94 / roll
		BS-LF007-86R-1-GL-G	86.6" (2.2m)	320gsm	200 x 300 18 x 12	\$64.58 / roll
		BS-LF007-98R-1-GL-G	98.4" (2.5m)	320gsm	200 x 300 18 x 12	\$73.39 / roll
		BS-LF007-110R-1-GL-G	110" (2.8m)	320gsm	200 x 300 18 x 12	\$82.19 / roll
		BS-LF007-125R-1-GL-G	125.9" (3.2m)	320gsm	200 x 300 18 x 12	\$93.94 / roll
Laminated Frontlit	BS-LF007-GL-G	BS-LF007-40R-GL-G	40" (1.02m)	340gsm	200 x 300 18 x 12	\$30.75 / roll
		BS-LF007-86R-GL-G	86.6" (2.2m)	340gsm	200 x 300 18 x 12	\$66.33 / roll
		BS-LF007-98R-GL-G	98.4" (2.5m)	340gsm	200 x 300 18 x 12	\$75.37 / roll
		BS-LF007-110R-GL-G	110" (2.8m)	340gsm	200 x 300 18 x 12	\$84.42 / roll
		BS-LF007-125R-GL-G	125.9" (3.2m)	340gsm	200 x 300 18 x 12	\$96.48 / roll
Laminated Frontlit	BS-LF008-GL	BS-LF008-40R-GL	40" (1.02m)	380gsm	300 x 500 18 x 12	\$31.97 / roll
		BS-LF008-86R-GL	86.6" (2.2m)	380gsm	300 x 500 18 x 12	\$68.94 / roll
		BS-LF008-98R-GL	98.4" (2.5m)	380gsm	300 x 500 18 x 12	\$78.34 / roll
		BS-LF008-110R-GL	110" (2.8m)	380gsm	300 x 500 18 x 12	\$87.75 / roll
		BS-LF008-125R-GL	125.9" (3.2m)	380gsm	300 x 500 18 x 12	\$100.29 / roll

## &gt; Materials and Inks &gt; Outdoor inkjet media &gt; PVC flex banner

Name	Series	Code	Width	Weight	Substrates	Price
Laminated Frontlit	BS-LF009-GL-G	BS-LF009-40R-GL-G	40" (1.02m)	440gsm	300 x 500 18 x 12	\$36.01 / roll
		BS-LF009-86R-GL-G	86.6" (2.2m)	440gsm	300 x 500 18 x 12	\$77.67 / roll
		BS-LF009-98R-GL-G	98.4" (2.5m)	440gsm	300 x 500 18 x 12	\$88.26 / roll
		BS-LF009-110R-GL-G	110" (2.8m)	440gsm	300 x 500 18 x 12	\$98.86 / roll
		BS-LF009-125R-GL-G	125.9" (3.2m)	440gsm	300 x 500 18 x 12	\$112.98 / roll
Laminated Frontlit	BS-LF009-GL-M	BS-LF009-40R-GL-M	40" (1.02m)	440gsm	300 x 500 18 x 12	\$36.01 / roll
		BS-LF009-86R-GL-M	86.6" (2.2m)	440gsm	300 x 500 18 x 12	\$77.67 / roll
		BS-LF009-98R-GL-M	98.4" (2.5m)	440gsm	300 x 500 18 x 12	\$88.26 / roll
		BS-LF009-110R-GL-M	110" (2.8m)	440gsm	300 x 500 18 x 12	\$98.86 / roll
		BS-LF009-125R-GL-M	125.9" (3.2m)	440gsm	300 x 500 18 x 12	\$112.98 / roll
Laminated Frontlit	BS-LF009-GL-W / G	BS-LF009-40R-GL-G	40" (1.02m)	440gsm	300 x 500 18 x 12	\$36.01 / roll
		BS-LF009-86R-GL-G	86.6" (2.2m)	440gsm	300 x 500 18 x 12	\$77.67 / roll
		BS-LF009-98R-GL-G	98.4" (2.5m)	440gsm	300 x 500 18 x 12	\$88.26 / roll
		BS-LF009-110R-GL-G	110" (2.8m)	440gsm	300 x 500 18 x 12	\$98.86 / roll
		BS-LF009-125R-GL-G	125.9" (3.2m)	440gsm	300 x 500 18 x 12	\$112.98 / roll
Laminated Frontlit	BS-LF009-GL-W / B	BS-LF009-40R-GL-GB	40" (1.02m)	440gsm	300 x 500 18 x 12	\$31.02 / roll
		BS-LF009-86R-GL-GB	86.6" (2.2m)	440gsm	300 x 500 18 x 12	\$66.92 / roll
		BS-LF009-98R-GL-GB	98.4" (2.5m)	440gsm	300 x 500 18 x 12	\$76.03 / roll
		BS-LF009-110R-GL-GB	110" (2.8m)	440gsm	300 x 500 18 x 12	\$85.16 / roll
		BS-LF009-125R-GL-GB	125.9" (3.2m)	440gsm	300 x 500 18 x 12	\$97.32 / roll
Laminated Frontlit	BS-LF010-GL-G	BS-LF010-40R-GL-G	40" (1.02m)	440gsm	500 x 500 18 x 12	\$37.63 / roll
		BS-LF010-86R-GL-G	86.6" (2.2m)	440gsm	500 x 500 18 x 12	\$81.16 / roll
		BS-LF010-98R-GL-G	98.4" (2.5m)	440gsm	500 x 500 18 x 12	\$92.23 / roll
		BS-LF010-110R-GL-G	110" (2.8m)	440gsm	500 x 500 18 x 12	\$103.3 / roll
		BS-LF010-125R-GL-G	125.9" (3.2m)	440gsm	500 x 500 18 x 12	\$118.06 / roll
Laminated Frontlit	BS-LF010-GL-M	BS-LF010-40R-GL-M	40" (1.02m)	440gsm	500 x 500 18 x 12	\$37.63 / roll
		BS-LF010-86R-GL-M	86.6" (2.2m)	440gsm	500 x 500 18 x 12	\$81.16 / roll
		BS-LF010-98R-GL-M	98.4" (2.5m)	440gsm	500 x 500 18 x 12	\$92.23 / roll
		BS-LF010-110R-GL-M	110" (2.8m)	440gsm	500 x 500 18 x 12	\$103.3 / roll
		BS-LF010-125R-GL-M	125.9" (3.2m)	440gsm	500 x 500 18 x 12	\$118.06 / roll
Laminated Frontlit	BS-LF010-GL-W / G	BS-LF010-40R-GL-G	40" (1.02m)	440gsm	500 x 500 18 x 12	\$37.63 / roll
		BS-LF010-86R-GL-G	86.6" (2.2m)	440gsm	500 x 500 18 x 12	\$81.16 / roll
		BS-LF010-98R-GL-G	98.4" (2.5m)	440gsm	500 x 500 18 x 12	\$92.23 / roll
		BS-LF010-110R-GL-G	110" (2.8m)	440gsm	500 x 500 18 x 12	\$103.3 / roll
		BS-LF010-125R-GL-G	125.9" (3.2m)	440gsm	500 x 500 18 x 12	\$118.06 / roll
Laminated Frontlit	BS-LF010-GL-W / B	BS-LF010-40R-GL-W / B	40" (1.02m)	440gsm	500 x 500 18 x 12	\$37.63 / roll
		BS-LF010-86R-GL-W / B	86.6" (2.2m)	440gsm	500 x 500 18 x 12	\$81.16 / roll
		BS-LF010-98R-GL-W / B	98.4" (2.5m)	440gsm	500 x 500 18 x 12	\$92.23 / roll
		BS-LF010-110R-GL-W / B	110" (2.8m)	440gsm	500 x 500 18 x 12	\$103.3 / roll
		BS-LF010-125R-GL-W / B	125.9" (3.2m)	440gsm	500 x 500 18 x 12	\$118.06 / roll
Laminated Frontlit	BS-LF011-GL-G	BS-LF011-40R-GL-G	40" (1.02m)	440gsm	1000 x 1000 9 x 9	\$37.63 / roll
		BS-LF011-86R-GL-G	86.6" (2.2m)	440gsm	1000 x 1000 9 x 9	\$81.16 / roll
		BS-LF011-98R-GL-G	98.4" (2.5m)	440gsm	1000 x 1000 9 x 9	\$92.23 / roll
		BS-LF011-110R-GL-G	110" (2.8m)	440gsm	1000 x 1000 9 x 9	\$103.3 / roll
		BS-LF011-125R-GL-G	125.9" (3.2m)	440gsm	1000 x 1000 9 x 9	\$118.06 / roll
Laminated Frontlit	BS-LF011-GL-M	BS-LF011-40R-GL-M	40" (1.02m)	440gsm	1000 x 1000 9 x 9	\$37.63 / roll
		BS-LF011-86R-GL-M	86.6" (2.2m)	440gsm	1000 x 1000 9 x 9	\$81.16 / roll
		BS-LF011-98R-GL-M	98.4" (2.5m)	440gsm	1000 x 1000 9 x 9	\$92.23 / roll
		BS-LF011-110R-GL-M	110" (2.8m)	440gsm	1000 x 1000 9 x 9	\$103.3 / roll
		BS-LF011-125R-GL-M	125.9" (3.2m)	440gsm	1000 x 1000 9 x 9	\$118.06 / roll
Laminated Frontlit	BS-LF011-GL-W / G	BS-LF011-40R-GL-W / G	40" (1.02m)	440gsm	1000 x 1000 9 x 9	\$37.63 / roll
		BS-LF011-86R-GL-W / G	86.6" (2.2m)	440gsm	1000 x 1000 9 x 9	\$81.16 / roll
		BS-LF011-98R-GL-W / G	98.4" (2.5m)	440gsm	1000 x 1000 9 x 9	\$92.23 / roll
		BS-LF011-110R-GL-W / G	110" (2.8m)	440gsm	1000 x 1000 9 x 9	\$103.3 / roll
		BS-LF011-125R-GL-W / G	125.9" (3.2m)	440gsm	1000 x 1000 9 x 9	\$118.06 / roll
Laminated Frontlit	BS-LF011-GL-W / B	BS-LF011-40R-GL-W / B	40" (1.02m)	440gsm	1000 x 1000 9 x 9	\$37.63 / roll
		BS-LF011-86R-GL-W / B	86.6" (2.2m)	440gsm	1000 x 1000 9 x 9	\$81.16 / roll
		BS-LF011-98R-GL-W / B	98.4" (2.5m)	440gsm	1000 x 1000 9 x 9	\$92.23 / roll
		BS-LF011-110R-GL-W / B	110" (2.8m)	440gsm	1000 x 1000 9 x 9	\$103.3 / roll
		BS-LF011-125R-GL-W / B	125.9" (3.2m)	440gsm	1000 x 1000 9 x 9	\$118.06 / roll



## &gt; Materials and Inks &gt; Outdoor inkjet media &gt; PVC flex banner

Name	Series	Code	Width	Weight	Substrates	Price
Laminated Frontlit	BS-LF011-1-GL-G	BS-LF011-1-40R-GL-G	40" (1.02m)	510gsm	1000 x 1000 9 x 9	\$37.63 / roll
		BS-LF011-1-86R-GL-G	86.6" (2.2m)	510gsm	1000 x 1000 9 x 9	\$81.16 / roll
		BS-LF011-1-98R-GL-G	98.4" (2.5m)	510gsm	1000 x 1000 9 x 9	\$92.23 / roll
		BS-LF011-1-110R-GL-G	110" (2.8m)	510gsm	1000 x 1000 9 x 9	\$103.3 / roll
		BS-LF011-1-125R-GL-G	125.9" (3.2m)	510gsm	1000 x 1000 9 x 9	\$118.06 / roll
Laminated Frontlit	BS-LF011-1-GL-W / B	BS-LF011-1-40R-GL-W / B	40" (1.02m)	510gsm	1000 x 1000 9 x 9	\$37.63 / roll
		BS-LF011-1-86R-GL-W / B	86.6" (2.2m)	510gsm	1000 x 1000 9 x 9	\$81.16 / roll
		BS-LF011-1-98R-GL-W / B	98.4" (2.5m)	510gsm	1000 x 1000 9 x 9	\$92.23 / roll
		BS-LF011-1-110R-GL-W / B	110" (2.8m)	510gsm	1000 x 1000 9 x 9	\$103.3 / roll
		BS-LF011-1-125R-GL-W / B	125.9" (3.2m)	510gsm	1000 x 1000 9 x 9	\$118.06 / roll
Laminated Frontlit	BS-LF012-GL	BS-LF012-40R-GL	40" (1.02m)	610gsm	1000 x 1000 12 x 12	\$63.93 / roll
		BS-LF012-86R-GL	86.6" (2.2m)	610gsm	1000 x 1000 12 x 12	\$137.89 / roll
		BS-LF012-98R-GL	98.4" (2.5m)	610gsm	1000 x 1000 12 x 12	\$156.7 / roll
		BS-LF012-110R-GL	110" (2.8m)	610gsm	1000 x 1000 12 x 12	\$175.5 / roll
		BS-LF012-125R-GL	125.9" (3.2m)	610gsm	1000 x 1000 12 x 12	\$200.57 / roll
Coated Frontlit	BS-CF013-GL	BS-CF013-40R-GL	40" (1.02m)	440gsm	500 x 500 28 x 28	\$65.55 / roll
		BS-CF013-86R-GL	86.6" (2.2m)	440gsm	500 x 500 28 x 28	\$141.36 / roll
		BS-CF013-98R-GL	98.4" (2.5m)	440gsm	500 x 500 28 x 28	\$160.66 / roll
		BS-CF013-110R-GL	110" (2.8m)	440gsm	500 x 500 28 x 28	\$179.94 / roll
		BS-CF013-125R-GL	125.9" (3.2m)	440gsm	500 x 500 28 x 28	\$205.65 / roll
Coated Frontlit	BS-CF013-1-GL	BS-CF013-1-40R-GL	40" (1.02m)	460gsm	1000 x 1000 18 x 18	\$63.93 / roll
		BS-CF013-1-86R-GL	86.6" (2.2m)	460gsm	1000 x 1000 18 x 18	\$137.89 / roll
		BS-CF013-1-98R-GL	98.4" (2.5m)	460gsm	1000 x 1000 18 x 18	\$156.7 / roll
		BS-CF013-1-110R-GL	110" (2.8m)	460gsm	1000 x 1000 18 x 18	\$175.5 / roll
		BS-CF013-1-125R-GL	125.9" (3.2m)	460gsm	1000 x 1000 18 x 18	\$200.57 / roll
Coated Frontlit	BS-CF014-GL	BS-CF014-40R-GL	40" (1.02m)	510gsm	1000 x 1000 20 x 20	\$65.55 / roll
		BS-CF014-86R-GL	86.6" (2.2m)	510gsm	1000 x 1000 20 x 20	\$141.36 / roll
		BS-CF014-98R-GL	98.4" (2.5m)	510gsm	1000 x 1000 20 x 20	\$160.66 / roll
		BS-CF014-110R-GL	110" (2.8m)	510gsm	1000 x 1000 20 x 20	\$179.94 / roll
		BS-CF014-125R-GL	126" (3.2m)	510gsm	1000 x 1000 20 x 20	\$205.65 / roll
Coated Frontlit	BS-CF015-GL	BS-CF015-40R-GL	40" (1.02m)	510gsm	1000 x 1000 20 x 20	\$65.55 / roll
		BS-CF015-86R-GL	86.6" (2.2m)	510gsm	1000 x 1000 20 x 20	\$141.36 / roll
		BS-CF015-98R-GL	98.4" (2.5m)	510gsm	1000 x 1000 20 x 20	\$160.66 / roll
		BS-CF015-110R-GL	110" (2.8m)	510gsm	1000 x 1000 20 x 20	\$179.94 / roll
		BS-CF015-125R-GL	126" (3.2m)	510gsm	1000 x 1000 20 x 20	\$205.65 / roll
Coated Blockout	BS-CF016-GL	BS-CF016-40R-GL	40" (1.02m)	440gsm	250 x 250 36 x 36	\$76.47 / roll
		BS-CF016-86R-GL	86.6" (2.2m)	440gsm	250 x 250 36 x 36	\$164.94 / roll
		BS-CF016-98R-GL	98.4" (2.5m)	440gsm	250 x 250 36 x 36	\$187.44 / roll
		BS-CF016-110R-GL	110" (2.8m)	440gsm	250 x 250 36 x 36	\$209.93 / roll
		BS-CF016-125R-GL	126" (3.2m)	440gsm	250 x 250 36 x 36	\$239.92 / roll
Coated Blockout	BS-CF017-GL	BS-CF017-40R-GL	40" (1.02m)	610gsm	1000 x 1000 20 x 20	\$85.78 / roll
		BS-CF017-86R-GL	86.6" (2.2m)	610gsm	1000 x 1000 20 x 20	\$185.2 / roll
		BS-CF017-98R-GL	98.4" (2.5m)	610gsm	1000 x 1000 20 x 20	\$210.25 / roll
		BS-CF017-110R-GL	110" (2.8m)	610gsm	1000 x 1000 20 x 20	\$235.48 / roll
		BS-CF017-125R-GL	126" (3.2m)	610gsm	1000 x 1000 20 x 20	\$268.8 / roll
Backlit Flex Banner	BS-LB-5050-HLD	BS-LB-5050-HLD-38YR	138" (3.51m)	610gsm	500 x 500 18 x 12	\$452.8 / roll
		BS-LB-5050-HLD-46YR	165" (4.2m)	610gsm	500 x 500 18 x 12	\$541.8 / roll
		BS-LB-5050-HLD-56YR	201" (5.1m)	610gsm	500 x 500 18 x 12	\$657.9 / roll
Backlit Flex Banner	BS-LB-N530-HLD	BS-LB-N530-HLD-38YR	138" (3.51m)	510gsm	300 x 500 18 x 12	\$236.7 / roll
		BS-LB-N530-HLD-46YR	165" (4.2m)	510gsm	300 x 500 18 x 12	\$474.6 / roll
		BS-LB-N530-HLD-56YR	201" (5.1m)	510gsm	300 x 500 18 x 12	\$343 / roll
Blockout Flex Banner	BS-BM-8080M-HLD	BS-BM-8080M-HLD-38YR	138" (3.51m)	610gsm	840 x 840 9 x 9	\$244.8 / roll
		BS-BM-8080M-HLD-46YR	165" (4.2m)	610gsm	840 x 840 9 x 9	\$292.8 / roll
		BS-BM-8080M-HLD-56YR	201" (5.1m)	610gsm	840 x 840 9 x 9	\$356 / roll
Frontlit Flex Banner	BS-FB-8080-HLD	BS-FB-8080-HLD-38YR	138" (3.51m)	440gsm	840 x 840 9 x 9	\$164.3 / roll
		BS-FB-8080-HLD-46YR	165" (4.2m)	440gsm	840 x 840 9 x 9	\$196.6 / roll
		BS-FB-8080-HLD-56YR	201" (5.1m)	440gsm	840 x 840 9 x 9	\$238.73 / roll

> Materials and Inks > Outdoor inkjet media > PVC flex banner

Name	Series	Code	Width	Weight	Substrates	Price
Frontlit Flex Banner	BS-FB-550-HLD	BS-FB-550-HLD-38YR	138" (3.51m)	440gsm	500 x 500 9 x 9	\$157.34 / roll
		BS-FB-550-HLD-46YR	165" (4.2m)	440gsm	500 x 500 9 x 9	\$188.27 / roll
		BS-FB-550-HLD-56YR	201" (5.1m)	440gsm	500 x 500 9 x 9	\$228.62 / roll
Frontlit Flex Banner	BS-FB-530-HLD	BS-FB-530-HLD-38YR	138" (3.51m)	440gsm	300 x 500 18 x 12	\$254.5 / roll
		BS-FB-530-HLD-46YR	165" (4.2m)	440gsm	300 x 500 18 x 12	\$304.5 / roll
		BS-FB-530-HLD-56YR	201" (5.1m)	440gsm	300 x 500 18 x 12	\$369.8 / roll

▼ Samples



## Coated Mesh Fabric

**Media Width:** 40" - 126" (1.02m - 3.2m), 138" - 201" (3.51 - 5.10m)

**Media Length:** 50m per roll

**Applications:** Digital printing, screen printing for wall murals, building cover & signboard.  
Large - scale advertising of the construction fence and the seaside amusement park

**About Price:** The price of advertising material products list on this book is the third ladder price.  
You can visit our website [www.sign-in-china.com](http://www.sign-in-china.com) for reference.



### ▼ Specifications (Quotation according to sq. m)

Name	Series	Weight	Substrates	Width	Price
Coated Mesh Fabric	BS-M119-TC	270gsm	1000 x 1000, 9 x 9	40" - 126" (1.02m - 3.2m)	\$1.02 / sq. m
Coated Mesh Fabric	BS-M112-TC	270gsm	1000 x 1000, 12 x 12	40" - 126" (1.02m - 3.2m)	\$1.13 / sq. m

### ▼ Specifications (Quotation according to roll)

Name	Series	Code	Width	Weight	Length / roll	Price
Coated Mesh Fabric	BS-M119-TC	BS-M119-40R-TC	40" (1.02m)	270gsm	1000 x 1000 9 x 9	\$51.79 / roll
		BS-M119-86R-TC	86.6" (2.2m)	270gsm	1000 x 1000 9 x 9	\$111.71 / roll
		BS-M119-98R-TC	98.4" (2.5m)	270gsm	1000 x 1000 9 x 9	\$126.94 / roll
		BS-M119-110R-TC	110" (2.8m)	270gsm	1000 x 1000 9 x 9	\$142.18 / roll
		BS-M119-125R-TC	126" (3.2m)	270gsm	1000 x 1000 9 x 9	\$162.49 / roll
Coated Mesh Fabric	BS-M112-TC	BS-M112-40R-TC	40" (1.02m)	270gsm	1000 x 1000 12 x 12	\$57.46 / roll
		BS-M112-86R-TC	86.6" (2.2m)	270gsm	1000 x 1000 12 x 12	\$123.93 / roll
		BS-M112-98R-TC	98.4" (2.5m)	270gsm	1000 x 1000 12 x 12	\$140.82 / roll
		BS-M112-110R-TC	110" (2.8m)	270gsm	1000 x 1000 12 x 12	\$157.73 / roll
		BS-M112-125R-TC	126" (3.2m)	270gsm	1000 x 1000 12 x 12	\$180.26 / roll

### ▼ Samples



# One Way Vision

**Media Width:** 24" / 36" / 36.8" / 42" / 50" / 60" (0.61m / 0.914m / 0.98m / 1.07m / 1.27m / 1.52m)

**Media Length:** 50m or 100m per roll

Good whiteness, wonderful hiding performance, and scalability - resistant, anti - UV, good ink absorbing, high accuracy of the screen printing, bright color, use the black coating between the film and glue, which can truly achieve non-residual gum, none - spilling gum and removable.

**Black coating technique:** The coating has the excellent adhesion of the PVC film, good intimacy of the acrylic type glue, as well as the excellent performance of climate - resistant.

From both technology and process, it achieves the perfect consistency on PVC film and black coating, black coating and acrylic type glue, as well as the acrylic type glue and the object which is pasted on, it finds fundamental solution of residing the black glue as other coating one - way - vision, as well as the problem of dirty surface and unclear picture which is made by the spilling glue from the hole of other one way vision.

## ▼ The scope of application:

Used for the wide format digital printing, ECO solvent printing and screen printing indoor and outdoor, mainly used in the advertising of the buses, taxis, subway and other means of transport glasses, glass wall, windows of shopping mall. Because of its one - way - vision function, it also can be used in various security areas, such as automated teller machines, interrogation rooms and airport areas.

## ▼ The application of the printer types:

**Solvent:** Vutek, Noel, Scitex, DGI, Teckwin, Yaselan, Flora, Fitto, Infinity, GongZheng, LiYu.

**ECO solvent:** Mutoh, Roland, 118.1" (3m), Mimaki and others.

**About Price:** The price of advertising material products list on this book is the third ladder price. You can visit our website [www.sign-in-china.com](http://www.sign-in-china.com) for reference.



## ▼ Specifications (Quotation according to sq. m)

Name	Model	Weight	PVC Face	Glue	Width	Length / roll	Price
One Way Vision (1 year Warranty)	BS-PO580-PY	180gsm	160µm	Removable, Transparent	38.6" / 42" / 50" / 60" (0.98m / 1.07m / 1.27m / 1.52m)	50m, 100m	\$1.82 / sq. m
One Way Vision (1 year Warranty)	BS-PO350-PY	140gsm	140µm	Removable, Transparent	50" / 60" (1.27m / 1.52m)	50m, 100m	\$1.35 / sq. m
One Way Vision (1 year Warranty)	BS-PO380-PY	180gsm	140µm	Removable, Transparent	38.6" / 42" / 50" / 60" (0.98m / 1.07m / 1.27m / 1.52m)	50m, 100m	\$1.51 / sq. m
One Way Vision (1 year Warranty)	BS-PO550-PY	140gsm	160µm	Removable, Transparent	38.6" / 42" / 50" / 60" (0.98m / 1.07m / 1.27m / 1.52m)	50m, 100m	
One Way Vision (3 years Warranty)	BS-POH4500-PY	140gsm	140µm	Removable, Transparent	38.6" / 42" / 50" / 60" (0.98m / 1.07m / 1.27m / 1.52m)	50m, 100m	\$1.51 / sq. m
One Way Vision (3 years Warranty)	BS-POH4800-PY	180gsm	260µm	Removable, Transparen	38.6" / 42" / 50" / 60" (0.98m / 1.07m / 1.27m / 1.52m)	50m, 100m	\$2.57 / sq. m

## &gt; Materials and Inks &gt; Outdoor inkjet media &gt; one way vision

## ▼ Specifications (Quotation according to roll)

Name	Series	Code	Width	Weight	Length / roll	Price
One Way Vision (1 year Warranty)	BS-PO580-PY	BS-PO580-38R-PY	38.6" (0.98m)	180gsm	50m	\$88.42 / roll
		BS-PO580-42R-PY	42" (1.07m)	180gsm	50m	\$97.62 / roll
		BS-PO580-50R-PY	50" (1.27m)	180gsm	50m	\$115.87 / roll
		BS-PO580-60R-PY	60" (1.52m)	180gsm	50m	\$138.32 / roll
One Way Vision (1 year Warranty)	BS-PO350-PY	BS-PO350-50R-PY	50" (1.27m)	140gsm	50m	\$85.65 / roll
		BS-PO350-60R-PY	60" (1.52m)	140gsm	50m	\$102.5 / roll
One Way Vision (1 year Warranty)	BS-PO380-PY	BS-PO380-38R-PY	38.6" (0.98m)	180gsm	50m	\$73.86 / roll
		BS-PO380-42R-PY	42" (1.07m)	180gsm	50m	\$80.65 / roll
		BS-PO380-50R-PY	50" (1.27m)	180gsm	50m	\$95.72 / roll
		BS-PO380-60R-PY	60" (1.52m)	180gsm	50m	\$114.57 / roll
One Way Vision (1 year Warranty)	BS-PO550-PY	BS-PO550-38R-PY	38.6" (0.98m)	140gsm	50m	\$81.64 / roll
		BS-PO550-42R-PY	42" (1.07m)	140gsm	50m	\$89.14 / roll
		BS-PO550-50R-PY	50" (1.27m)	140gsm	50m	\$105.8 / roll
		BS-PO550-60R-PY	60" (1.52m)	140gsm	50m	\$126.62 / roll
One Way Vision (3 years Warranty)	BS-POH4500-PY	BS-POH4500-38R-PY	38.6" (0.98m)	140gsm	50m	\$118.18 / roll
		BS-POH4500-42R-PY	42" (1.07m)	140gsm	50m	\$129.14 / roll
		BS-POH4500-50R-PY	50" (1.27m)	140gsm	50m	\$153.15 / roll
		BS-POH4500-60R-PY	60" (1.52m)	140gsm	50m	\$183.30 / roll
One Way Vision (3 years Warranty)	BS-POH4800-PY	BS-POH4800-38R-PY	38.6" (0.98m)	180gsm	50m	\$125.96 / roll
		BS-POH4800-42R-PY	42" (1.07m)	180gsm	50m	\$137.53 / roll
		BS-POH4800-50R-PY	50" (1.27m)	180gsm	50m	\$163.23 / roll
		BS-POH4800-60R-PY	60" (1.52m)	180gsm	50m	\$195.38 / roll

## ▼ Samples



# PVC Tarpaulin

**Media Width:** 40 - 126" (1.02 - 3.2m)

**Media Length:** 50m per roll

Opaque product with high intensity and good elasticity. Good ANTI - LIGHT is the characteristic for the materials, moreover, demanded images can be printed on the surface of the product by inkjet to enhance vision effect and enlarge its usage.

**Packing:** Inner cores are packed with craft paper or hard tube.

**Application:** Used for truck cover, tent, awning, covers, etc.

**About Price:** The price of advertising material products list on this book is the third ladder price.

You can visit our website [www.sign-in-china.com](http://www.sign-in-china.com) for reference.



## ▼ Specifications (Quotation according to sq. m)

Name	Model	Weight	Substrates	Width	Price
Coated Tarpaulin (610gsm)	BS-CTO18-GL	610gsm	1000 x 1000 20 x 20	40 - 126" (1.02 - 3.2m)	\$2.02 / sq. m
Coated Tarpaulin (650gsm)	BS-CTO19-GL	650gsm	1000 x 1300 20 x 18	40 - 126" (1.02 - 3.2m)	\$2.15 / sq. m
Coated Tarpaulin (700gsm)	BS-CTO20-GL	700gsm	1000 x 1300 20 x 18	40 - 126" (1.02 - 3.2m)	\$2.29 / sq. m
Coated Tarpaulin (950gsm)	BS-CTO21-GL	950gsm	1000 x 1300 20 x 18	40 - 126" (1.02 - 3.2m)	\$2.83 / sq. m
Coated Blockout Tarpaulin (800gsm)	BS-CTO22-GL	800gsm	1000 x 1300 20 x 18	40 - 126" (1.02 - 3.2m)	\$2.55 / sq. m
Coated Blockout Tarpaulin (900gsm)	BS-CTO23-GL	900gsm	1000 x 1300 20 x 18	40 - 126" (1.02 - 3.2m)	\$2.96 / sq. m
Side Curtain	BS-SCO24-GL	700gsm	1000 x 1300 20 x 18	40 - 126" (1.02 - 3.2m)	\$2.42 / sq. m
Side Curtain	BS-SCTO25-GL	900gsm	1000 x 1000 30 x 30	40 - 126" (1.02 - 3.2m)	\$3.56 / sq. m
Side Curtain	BS-SCO26-GL	1100gsm	1000 x 1000 30 x 30	40 - 126" (1.02 - 3.2m)	\$3.64 / sq. m
Laminated Tarpaulin	BS-LTO27-GL	610gsm	1000 x 1000 9 x 9	40 - 126" (1.02 - 3.2m)	\$1.48 / sq. m
Laminated Tarpaulin	BS-LTO28-GL	650gsm	1000 x 1000 9 x 9	40 - 126" (1.02 - 3.2m)	\$1.62 / sq. m

## ▼ Specifications (Quotation according to roll) Media Length: 50m per roll

Name	Series	Code	Width	Weight	Substrates	Price
Coated Tarpaulin (610gsm)	BS-CTO18-GL	BS-CTO18-40R-GL	40" (1.02m)	610gsm	1000 x 1000 20 x 20	\$103.14 / roll
		BS-CTO18-86R-GL	86.6" (2.2m)	610gsm	1000 x 1000 20 x 20	\$222.68 / roll
		BS-CTO18-98R-GL	98" (2.5m)	610gsm	1000 x 1000 20 x 20	\$252.8 / roll
		BS-CTO18-110R-GL	110" (2.8m)	610gsm	1000 x 1000 20 x 20	\$283.2 / roll
		BS-CTO18-125R-GL	126" (3.2m)	610gsm	1000 x 1000 20 x 20	\$388.8 / roll
Coated Tarpaulin (650gsm)	BS-CTO19-GL	BS-CTO19-40R-GL	40" (1.02m)	650gsm	1000 x 1300 20 x 18	\$110.02 / roll
		BS-CTO19-86R-GL	86.6" (2.2m)	650gsm	1000 x 1300 20 x 18	\$237.35 / roll
		BS-CTO19-98R-GL	98" (2.5m)	650gsm	1000 x 1300 20 x 18	\$269.6 / roll
		BS-CTO19-110R-GL	110" (2.8m)	650gsm	1000 x 1300 20 x 18	\$301 / roll
Coated Tarpaulin (700gsm)	BS-CTO20-GL	BS-CTO19-125R-GL	126" (3.2m)	650gsm	1000 x 1300 20 x 18	\$344 / roll
		BS-CTO20-40R-GL	40" (1.02m)	700gsm	1000 x 1300 20 x 18	\$116.9 / roll
		BS-CTO20-86R-GL	86.6" (2.2m)	700gsm	1000 x 1300 20 x 18	\$252 / roll
		BS-CTO20-98R-GL	98" (2.5m)	700gsm	1000 x 1300 20 x 18	\$286.4 / roll
		BS-CTO20-110R-GL	110" (2.8m)	700gsm	1000 x 1300 20 x 18	\$320 / roll
		BS-CTO20-125R-GL	126" (3.2m)	700gsm	1000 x 1300 20 x 18	\$366 / roll

## &gt; Materials and Inks &gt; Outdoor inkjet media &gt; PVC tarpaulin

Name	Series	Code	Width	Weight	Substrates	Price
Coated Tarpaulin (950gsm)	BS-CTO21-GL	BS-CTO21-40R-GL	40" (1.02m)	950gsm	1000 x 1300 20 x 18	\$144.4 / roll
		BS-CTO21-86R-GL	86.6" (2.2m)	950gsm	1000 x 1300 20 x 18	\$311 / roll
		BS-CTO21-98R-GL	98" (2.5m)	950gsm	1000 x 1300 20 x 18	\$353 / roll
		BS-CTO21-110R-GL	110" (2.8m)	950gsm	1000 x 1300 20 x 18	\$396 / roll
		BS-CTO21-125R-GL	126" (3.2m)	950gsm	1000 x 1300 20 x 18	\$452 / roll
Coated Blockout Tarpaulin (800gsm)	BS-CTO22-GL	BS-CTO22-40R-GL	40" (1.02m)	800gsm	1000 x 1300 20 x 18	\$130.38 / roll
		BS-CTO22-86R-GL	86.6" (2.2m)	800gsm	1000 x 1300 20 x 18	\$280.8 / roll
		BS-CTO22-98R-GL	98" (2.5m)	800gsm	1000 x 1300 20 x 18	\$319 / roll
		BS-CTO22-110R-GL	110" (2.8m)	800gsm	1000 x 1300 20 x 18	\$357 / roll
Coated Blockout Tarpaulin (900gsm)	BS-CTO23-GL	BS-CTO23-125R-GL	126" (3.2m)	800gsm	1000 x 1300 20 x 18	\$408 / roll
		BS-CTO23-40R-GL	40" (1.02m)	900gsm	1000 x 1300 20 x 18	\$151.27 / roll
		BS-CTO23-86R-GL	86.6" (2.2m)	900gsm	1000 x 1300 20 x 18	\$325 / roll
		BS-CTO23-98R-GL	98" (2.5m)	900gsm	1000 x 1300 20 x 18	\$370 / roll
Side Curtain	BS-SCO24-GL	BS-CTO23-110R-GL	110" (2.8m)	900gsm	1000 x 1300 20 x 18	\$415 / roll
		BS-SCO24-40R-GL	40" (1.02m)	700gsm	1000 x 1300 20 x 18	\$123.64 / roll
		BS-SCO24-86R-GL	86.6" (2.2m)	700gsm	1000 x 1300 20 x 18	\$266.4 / roll
		BS-SCO24-98R-GL	98" (2.5m)	700gsm	1000 x 1300 20 x 18	\$302 / roll
		BS-SCO24-110R-GL	110" (2.8m)	700gsm	1000 x 1300 20 x 18	\$338 / roll
Side Curtain	BS-SCO25-GL	BS-SCO24-125R-GL	126" (3.2m)	700gsm	1000 x 1300 20 x 18	\$387 / roll
		BS-SCO25-40R-GL	40" (1.02m)	900gsm	1000 x 1000 30 x 30	\$158.02 / roll
		BS-SCO25-86R-GL	86.6" (2.2m)	900gsm	1000 x 1000 30 x 30	\$340 / roll
		BS-SCO25-98R-GL	98" (2.5m)	900gsm	1000 x 1000 30 x 30	\$387 / roll
Side Curtain	BS-SCO26-GL	BS-SCO25-110R-GL	110" (2.8m)	900gsm	1000 x 1000 30 x 30	\$433 / roll
		BS-SCO26-40R-GL	40" (1.02m)	1100gsm	1000 x 1000 30 x 30	\$185.66 / roll
		BS-SCO26-86R-GL	86.6" (2.2m)	1100gsm	1000 x 1000 30 x 30	\$400 / roll
		BS-SCO26-98R-GL	98" (2.5m)	1100gsm	1000 x 1000 30 x 30	\$454 / roll
		BS-SCO26-110R-GL	110" (2.8m)	1100gsm	1000 x 1000 30 x 30	\$509 / roll
Laminated Tarpaulin	BS-LTO27-GL	BS-SCO26-125R-GL	126" (3.2m)	1100gsm	1000 x 1000 30 x 30	\$582 / roll
		BS-LTO27-40R-GL	40" (1.02m)	610gsm	1000 x 1000 9 x 9	\$75.64 / roll
		BS-LTO27-86R-GL	86.6" (2.2m)	610gsm	1000 x 1000 9 x 9	\$163.04 / roll
		BS-LTO27-98R-GL	98" (2.5m)	610gsm	1000 x 1000 9 x 9	\$185.39 / roll
Laminated Tarpaulin	BS-LTO28-GL	BS-LTO27-110R-GL	110" (2.8m)	610gsm	1000 x 1000 9 x 9	\$207.6 / roll
		BS-LTO27-125R-GL	126" (3.2m)	610gsm	1000 x 1000 9 x 9	\$237.22 / roll
		BS-LTO28-40R-GL	40" (1.02m)	650gsm	1000 x 1000 9 x 9	\$82.38 / roll
		BS-LTO28-86R-GL	86.6" (2.2m)	650gsm	1000 x 1000 9 x 9	\$177.72 / roll
		BS-LTO28-98R-GL	98" (2.5m)	650gsm	1000 x 1000 9 x 9	\$202.5 / roll
		BS-LTO28-110R-GL	110" (2.8m)	650gsm	1000 x 1000 9 x 9	\$226.25 / roll
		BS-LTO28-125R-GL	126" (3.2m)	650gsm	1000 x 1000 9 x 9	\$258.4 / roll

## ▼ Samples



## ECO Inkjet Media

**Media Width:** 36" / 42" / 50" / 60" (0.914m / 1.07m / 1.27m / 1.52m)

**Media Length:** 30m per roll

- ECO is considered as environmentally safe, uncoated media and outdoor durable material that have featured the inkjet printers of ECO - solvent ink.
- ECO - solvent ink keep a high resolution printing the same as water based ink, and it also can be applied to more different media for outdoor use.
- Therefore, ECO - solvent ink integrates advantages of solvent and water based ink into one integration.
- ECO printing media is usually used for high resolution printing equipment, with colors highly saturated and distinct, and can be printed by Roland, Mimaki, Mutoh, Epson, etc.
- People usually print a picture of several square meters, with a width less than 1.5 meter and a length of 3 - 5 meter, shown as posters and advertisement in marketplaces, exhibition fairs, etc. ECO printing media is packed in rolls.

**About Price:** The price of advertising material products list on this book is the third ladder price.

You can visit our website [www.sign-in-china.com](http://www.sign-in-china.com) for reference.



### ▼ Samples



### ▼ Specifications (Quotation according to sq. m)

Name	Series	Thickness	Width	Price
ECO Glossy Photo Paper	BS-PH-180QG-NS	180gsm	36" / 42" / 50" / 60" (0.914m / 1.07m / 1.27m / 1.52m)	\$1.49 / sq. m
ECO Glossy Photo Paper	BS-PH-220QG-NS	220gsm	36" / 42" / 50" / 60" (0.914m / 1.07m / 1.27m / 1.52m)	\$1.49 / sq. m
ECO Matte Photo Paper	BS-PH-180QM-NS	180gsm	36" / 42" / 50" / 60" (0.914m / 1.07m / 1.27m / 1.52m)	\$1.49 / sq. m
ECO Matte Photo Paper	BS-PH-220QM-NS	220gsm	36" / 42" / 50" / 60" (0.914m / 1.07m / 1.27m / 1.52m)	\$1.49 / sq. m
ECO Glossy Photo Paper S / A	BS-PH-150QGL-NS	150gsm	36" / 42" / 50" / 60" (0.914m / 1.07m / 1.27m / 1.52m)	\$1.81 / sq. m
ECO Glossy Photo Paper S / A	BS-PH-150QML-NS	150gsm	36" / 42" / 50" / 60" (0.914m / 1.07m / 1.27m / 1.52m)	\$1.81 / sq. m
ECO Glossy PP Film	BS-150QG-NS	150μm	36" / 42" / 50" / 60" (0.914m / 1.07m / 1.27m / 1.52m)	\$1.49 / sq. m
ECO Glossy PP Film	BS-180QG-NS	180μm	36" / 42" / 50" / 60" (0.914m / 1.07m / 1.27m / 1.52m)	\$1.49 / sq. m
ECO Matte PP Film	BS-150QM-NS	150μm	36" / 42" / 50" / 60" (0.914m / 1.07m / 1.27m / 1.52m)	\$1.49 / sq. m
ECO Matte PP Film	BS-180QM-NS	180μm	36" / 42" / 50" / 60" (0.914m / 1.07m / 1.27m / 1.52m)	\$1.49 / sq. m
ECO Glossy PP S / A	BS-120QGL-NS	120gsm	36" / 42" / 50" / 60" (0.914m / 1.07m / 1.27m / 1.52m)	\$1.65 / sq. m
ECO Matte PP S / A	BS-120QML-NS	120gsm	36" / 42" / 50" / 60" (0.914m / 1.07m / 1.27m / 1.52m)	\$1.65 / sq. m
ECO Front Print Backlit Film	BS-FB-110QM-NS	110μm	36" / 42" / 50" / 60" (0.914m / 1.07m / 1.27m / 1.52m)	\$1.81 / sq. m
ECO Front Print Backlit Film	BS-FB-210QM-NS	210μm	36" / 42" / 50" / 60" (0.914m / 1.07m / 1.27m / 1.52m)	\$2.80 / sq. m
ECO Semi - transparent White PET	BS-TF-100QM-NS	100gsm	36" / 42" / 50" / 60" (0.914m / 1.07m / 1.27m / 1.52m)	\$2.14 / sq. m
ECO Semi - transparent White PET	BS-TF-200QM-NS	200gsm	36" / 42" / 50" / 60" (0.914m / 1.07m / 1.27m / 1.52m)	\$2.80 / sq. m
ECO Matte White PET	BS-ETF-100QM-NS	100gsm	36" / 42" / 50" / 60" (0.914m / 1.07m / 1.27m / 1.52m)	\$1.98 / sq. m
ECO Matte White PET	BS-ETF-200QM-NS	200gsm	36" / 42" / 50" / 60" (0.914m / 1.07m / 1.27m / 1.52m)	\$2.91 / sq. m
ECO Matte Grey Back PET	BS-TF-125QMB-NS	125gsm	36" / 42" / 50" / 60" (0.914m / 1.07m / 1.27m / 1.52m)	\$2.96 / sq. m
ECO Matte Grey Back PET	BS-TF-175QMB-NS	175gsm	36" / 42" / 50" / 60" (0.914m / 1.07m / 1.27m / 1.52m)	\$2.43 / sq. m
ECO Inkjet Paper Blue Back (Semi - glossy)	BS-PH-120QMB-NS	120gsm	36" / 42" / 50" / 60" (0.914m / 1.07m / 1.27m / 1.52m)	\$2.14 / sq. m
ECO Inkjet Paper Blue Back (Glossy)	BS-PH-120QGB-NS	120gsm	36" / 42" / 50" / 60" (0.914m / 1.07m / 1.27m / 1.52m)	\$0.97 / sq. m
ECO Ordinary Blue Back Poster Paper	BS-PH-120WB-NS	120gsm	36" / 42" / 50" / 60" (0.914m / 1.07m / 1.27m / 1.52m)	\$0.81 / sq. m
ECO Matte Blue Back Poster Paper	BS-PH-120MB-NS	120gsm	36" / 42" / 50" / 60" (0.914m / 1.07m / 1.27m / 1.52m)	\$0.81 / sq. m
ECO Transparent Film	BS-TF-100QT-NS	100μm	36" / 42" / 50" / 60" (0.914m / 1.07m / 1.27m / 1.52m)	\$2.27 / sq. m



## &gt; Materials and Inks &gt; ECO inkjet media

## ▼ Specifications (Quotation according to roll) Media Length: 30m / roll

Name	Series	Code	Width	Weight	Price
ECO Glossy Photo Paper	BS-PH-180QG-NS	BS-PH-180QG-36R-NS	36" (0.914m)	180gsm	\$40 / roll
		BS-PH-180QG-42R-NS	42" (1.07m)	180gsm	\$46.9 / roll
		BS-PH-180QG-50R-NS	50" (1.27m)	180gsm	\$55.6 / roll
		BS-PH-180QG-60R-NS	60" (1.52m)	180gsm	\$66.6 / roll
ECO Glossy Photo Paper	BS-PH-220QG-NS	BS-PH-220QG-36R-NS	36" (0.914m)	220gsm	\$40 / roll
		BS-PH-220QG-42R-NS	42" (1.07m)	220gsm	\$46.9 / roll
		BS-PH-220QG-50R-NS	50" (1.27m)	220gsm	\$55.6 / roll
		BS-PH-220QG-60R-NS	60" (1.52m)	220gsm	\$66.6 / roll
ECO Matte Photo Paper	BS-PH-180QM-NS	BS-PH-180QM-36R-NS	36" (0.914m)	180gsm	\$40 / roll
		BS-PH-180QM-42R-NS	42" (1.07m)	180gsm	\$46.9 / roll
		BS-PH-180QM-50R-NS	50" (1.27m)	180gsm	\$55.6 / roll
		BS-PH-180QM-60R-NS	60" (1.52m)	180gsm	\$66.6 / roll
ECO Matte Photo Paper	BS-PH-220QM-NS	BS-PH-220QM-36R-NS	36" (0.914m)	220gsm	\$40 / roll
		BS-PH-220QM-42R-NS	42" (1.07m)	220gsm	\$46.9 / roll
		BS-PH-220QM-50R-NS	50" (1.27m)	220gsm	\$55.6 / roll
		BS-PH-220QM-60R-NS	60" (1.52m)	220gsm	\$66.6 / roll
ECO Glossy Photo Paper S / A	BS-PH-150QGL-NS	BS-PH-150QGL-36R-NS	36" (0.914m)	150gsm	\$48.4 / roll
		BS-PH-150QGL-42R-NS	42" (1.07m)	150gsm	\$57.1 / roll
		BS-PH-150QGL-50R-NS	50" (1.27m)	150gsm	\$67.8 / roll
		BS-PH-150QGL-60R-NS	60" (1.52m)	150gsm	\$81.2 / roll
ECO Matte Photo Paper S / A	BS-PH-150QML-NS	BS-PH-150QML-36R-NS	36" (0.914m)	150gsm	\$48.4 / roll
		BS-PH-150QML-42R-NS	42" (1.07m)	150gsm	\$57.1 / roll
		BS-PH-150QML-50R-NS	50" (1.27m)	150gsm	\$67.8 / roll
		BS-PH-150QML-60R-NS	60" (1.52m)	150gsm	\$81.2 / roll
ECO Inkjet Paper Blue Back (Semi - glossy)	BS-PH-120QMB-NS	BS-PH-120QMB-36R-NS	36" (0.914m)	120gsm	\$26.6 / roll
		BS-PH-120QMB-42R-NS	42" (1.07m)	120gsm	\$31.1 / roll
		BS-PH-120QMB-50R-NS	50" (1.27m)	120gsm	\$37 / roll
		BS-PH-120QMB-60R-NS	60" (1.52m)	120gsm	\$44.2 / roll
ECO Inkjet Paper Blue Back (Glossy)	BS-PH-120QGB-NS	BS-PH-120QGB-36R-NS	36" (0.914m)	120gsm	\$26.6 / roll
		BS-PH-120QGB-42R-NS	42" (1.07m)	120gsm	\$31.1 / roll
		BS-PH-120QGB-50R-NS	50" (1.27m)	120gsm	\$37 / roll
		BS-PH-120QGB-60R-NS	60" (1.52m)	120gsm	\$44.2 / roll
ECO Ordinary Paper Blue Back Poster Paper	BS-PH-120WB-NS	BS-PH-120WB-36R-NS	36" (0.914m)	120gsm	\$22.2 / roll
		BS-PH-120WB-42R-NS	42" (1.07m)	120gsm	\$26 / roll
		BS-PH-120WB-50R-NS	50" (1.27m)	120gsm	\$30.9 / roll
		BS-PH-120WB-60R-NS	60" (1.52m)	120gsm	\$36.9 / roll
ECO Matte Blue Back Poster Paper	BS-PH-120MB-NS	BS-PH-120MB-36R-NS	36" (0.914m)	120gsm	\$22.2 / roll
		BS-PH-120MB-42R-NS	42" (1.07m)	120gsm	\$26 / roll
		BS-PH-120MB-50R-NS	50" (1.27m)	120gsm	\$30.9 / roll
		BS-PH-120MB-60R-NS	60" (1.52m)	120gsm	\$36.9 / roll

Name	Series	Code	Width	Thickness	Price
ECO Glossy PP Film	BS-150QG-NS	BS-150QG-36R-NS	36" (0.914m)	150μm	\$40 / roll
		BS-150QG-42R-NS	42" (1.07m)	150μm	\$46.9 / roll
		BS-150QG-50R-NS	50" (1.27m)	150μm	\$55.6 / roll
		BS-150QG-60R-NS	60" (1.52m)	150μm	\$66.6 / roll
ECO Glossy PP Film	BS-180QG-NS	BS-180QG-36R-NS	36" (0.914m)	180μm	\$40 / roll
		BS-180QG-42R-NS	42" (1.07m)	180μm	\$46.9 / roll
		BS-180QG-50R-NS	50" (1.27m)	180μm	\$55.6 / roll
		BS-180QG-60R-NS	60" (1.52m)	180μm	\$66.6 / roll

## &gt; Materials and Inks &gt; ECO inkjet media

Name	Series	Code	Width	Thickness	Price
ECO Matte PP Film	BS-150QM-NS	BS-150QM-36R-NS	36" (0.914m)	150µm	\$40 / roll
		BS-150QM-42R-NS	42" (1.07m)	150µm	\$46.9 / roll
		BS-150QM-50R-NS	50" (1.27m)	150µm	\$55.6 / roll
		BS-150QM-60R-NS	60" (1.52m)	150µm	\$66.6 / roll
ECO Matte PP Film	BS-180QM-NS	BS-180QM-36R-NS	36" (0.914m)	180µm	\$40 / roll
		BS-180QM-42R-NS	42" (1.07m)	180µm	\$46.9 / roll
		BS-180QM-50R-NS	50" (1.27m)	180µm	\$55.6 / roll
		BS-180QM-60R-NS	60" (1.52m)	180µm	\$66.6 / roll
ECO Glossy PP S / A	BS-120QGL-NS	BS-120QGL-36R-NS	36" (0.914m)	120µm	\$44.4 / roll
		BS-120QGL-42R-NS	42" (1.07m)	120µm	\$52 / roll
		BS-120QGL-50R-NS	50" (1.27m)	120µm	\$61.7 / roll
		BS-120QGL-60R-NS	60" (1.52m)	120µm	\$73.9 / roll
ECO Matte PP S / A	BS-120QML-NS	BS-120QML-36R-NS	36" (0.914m)	120µm	\$44.4 / roll
		BS-120QML-42R-NS	42" (1.07m)	120µm	\$52 / roll
		BS-120QML-50R-NS	50" (1.27m)	120µm	\$61.7 / roll
		BS-120QML-60R-NS	60" (1.52m)	120µm	\$73.9 / roll
ECO Front Print Backlit Film	BS-FB-110QM-NS	BS-FB-110QM-36R-NS	36" (0.914m)	110µm	\$48.4 / roll
		BS-FB-110QM-42R-NS	42" (1.07m)	110µm	\$57.1 / roll
		BS-FB-110QM-50R-NS	50" (1.27m)	110µm	\$67.8 / roll
		BS-FB-110QM-60R-NS	60" (1.52m)	110µm	\$81.2 / roll
ECO Front Print Backlit Film	BS-FB-210QM-NS	BS-FB-210QM-36R-NS	36" (0.914m)	110µm	\$75.4 / roll
		BS-FB-210QM-42R-NS	42" (1.07m)	110µm	\$88.3 / roll
		BS-FB-210QM-50R-NS	50" (1.27m)	110µm	\$104.8 / roll
		BS-FB-210QM-60R-NS	60" (1.52m)	110µm	\$125.4 / roll
ECO Semi - transparent White PET	BS-TF-100QM-NS	BS-TF-100QM-36R-NS	36" (0.914m)	100µm	\$57.5 / roll
		BS-TF-100QM-42R-NS	42" (1.07m)	100µm	\$67.4 / roll
		BS-TF-100QM-50R-NS	50" (1.27m)	100µm	\$80 / roll
		BS-TF-100QM-60R-NS	60" (1.52m)	100µm	\$95.8 / roll
ECO Semi - transparent White PET	BS-TF-200QM-NS	BS-TF-200QM-36R-NS	36" (0.914m)	200µm	\$75.4 / roll
		BS-TF-200QM-42R-NS	42" (1.07m)	200µm	\$88.3 / roll
		BS-TF-200QM-50R-NS	50" (1.27m)	200µm	\$104.8 / roll
		BS-TF-200QM-60R-NS	60" (1.52m)	200µm	\$125.4 / roll
ECO Matte White PET	BS-ETF-100QM-NS	BS-ETF-100QM-36R-NS	36" (0.914m)	100µm	\$53.2 / roll
		BS-ETF-100QM-42R-NS	42" (1.07m)	100µm	\$62.2 / roll
		BS-ETF-100QM-50R-NS	50" (1.27m)	100µm	\$73.9 / roll
		BS-ETF-100QM-60R-NS	60" (1.52m)	100µm	\$88.5 / roll
ECO Matte White PET	BS-ETF-200QM-NS	BS-ETF-200QM-36R-NS	36" (0.914m)	200µm	\$79.7 / roll
		BS-ETF-200QM-42R-NS	42" (1.07m)	200µm	\$93.4 / roll
		BS-ETF-200QM-50R-NS	50" (1.27m)	200µm	\$110.9 / roll
		BS-ETF-200QM-60R-NS	60" (1.52m)	200µm	\$132.7 / roll
ECO Matte Grey Back PET	BS-TF-125QMB-NS	BS-TF-125QMB-36R-NS	36" (0.914m)	125µm	\$57.5 / roll
		BS-TF-125QMB-42R-NS	42" (1.07m)	125µm	\$67.4 / roll
		BS-TF-125QMB-50R-NS	50" (1.27m)	125µm	\$80 / roll
		BS-TF-125QMB-60R-NS	60" (1.52m)	125µm	\$95.8 / roll
ECO Matte Grey Back PET	BS-TF-175QMB-NS	BS-TF-175QMB-36R-NS	36" (0.914m)	175µm	\$66.6 / roll
		BS-TF-175QMB-42R-NS	42" (1.07m)	175µm	\$78 / roll
		BS-TF-175QMB-50R-NS	50" (1.27m)	175µm	\$92.6 / roll
		BS-TF-175QMB-60R-NS	60" (1.52m)	175µm	\$110.8 / roll
ECO Transparent Film	BS-TF-100QT-NS	BS-TF-100QT-36R-NS	36" (0.914m)	100µm	\$62.2 / roll
		BS-TF-100QT-42R-NS	42" (1.07m)	100µm	\$72.9 / roll
		BS-TF-100QT-50R-NS	50" (1.27m)	100µm	\$86.5 / roll
		BS-TF-100QT-60R-NS	60" (1.52m)	100µm	\$103.5 / roll

## > Materials and Inks > Magnetic printing material

### Flexible Steel Media

- This steel film is a flexible and printable magnetic receptive material. It's not magnet, but it can be easily placed on magnetic boards.
- This easy - to - change and long term durable film has good holding power and stability, which makes it perfect for indoor and outdoor POP when you use magnetic boards together.
- If you use the steel film and the flexible magnet together to make up a Rapid Display POP System, it will give you an innovative, standard, unified and simple POP way.

#### ▼ Typical Applications

Easy - to - install, removable, reusable, be used for general signage and other flat - surface / curved - surface, medium - term, indoor and outdoor application, such as:

- Point of purchase display / commercial signage in super market, retail / grocery shops, and restaurant.
- Removable / changeable advertisements in subway, railway station, business center.
- Business wall outside.
- Map guide in exhibition center, road side.
- Kids wall in house.

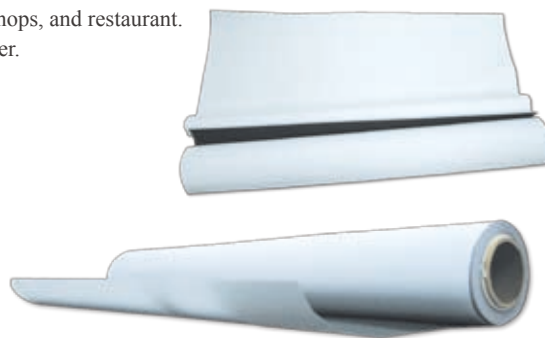

#### ▼ Specifications

Model	SIC-FF-SOL-CT340	SIC-NM-SOL-CT30B	SIC-NM-UV-CT30B	SIC-FF-UV-CT320
Surface	PET, white	PET, white	PET	PET, white
Finishing Effect	Semi - gloss	Gloss (waterproof)	Gloss (waterproof)	Semi - gloss
Substrate	Steel	Magnet	Magnet	Steel
Weight	350g / m <sup>2</sup>	350g / m <sup>2</sup>	350g / m <sup>2</sup>	350g / m <sup>2</sup>
Thickness	0.18mm	0.3mm	0.3mm	0.17mm
Available Length	32.8Y (30m)	32.8Y (30m)	32.8Y (30m)	32.8Y (30m)
Available Width	36" / 42" / 50" / 60" / 64" (0.914m / 1.07m / 1.27m / 1.524m / 1.626m)	50" / 60" / 64" (1.27m / 1.524m / 1.626m)	50" / 54" / 60" (1.27m / 1.37m / 1.524m)	50" / 60" / 64" (1.27m / 1.524m / 1.626m)
Shelf Life	2 years	2 years	2 years	2 years
Application Recommendation	POP / Exhibit	POP / Exhibit	POP / Exhibit	POP / Exhibit
Printing Method	Solvent, Eco - solvent	Solvent & ECO - solvent printer compatible	UV & Latex printer compatible	UV, Latex
Temperature Range After Application	-20°C to +70°C	-20°C to +70°C	-20°C to +70°C	-20°C to +70°C
<b>Price</b>	<b>\$5.93 / sq. m</b>	<b>\$6.43 / sq. m</b>	<b>\$6.43 / sq. m</b>	<b>\$5.93 / sq. m</b>

#### ▼ How to display & How to remove and reuse

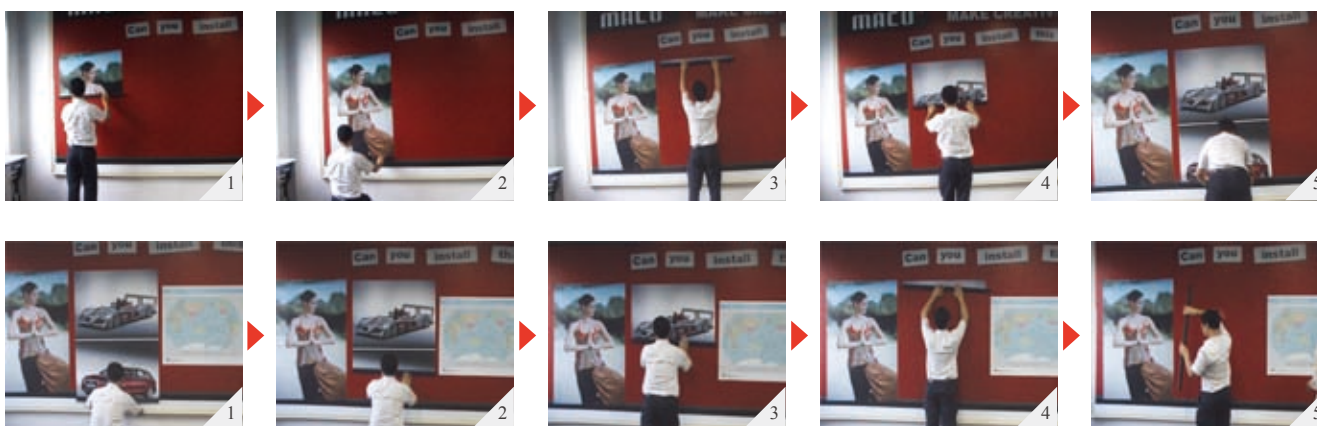

## &gt; Materials and Inks &gt; Magnetic printing material

**Flexible Standard Magnetic Sheet**

- This rubber sheet is normal flexible magnet.
- It can be widely used for POP display and fridge magnet, refrigerator magnets, car signs, safety signs, business cards, shelf labels, puzzles, educational items, toys, menu boards and so on.
- Using this sheet directly as a back panel to adhesive steel film is perfect.
- Temperature range after application: -20°C to +70°C,
- UV processing on the magnetizing surface.

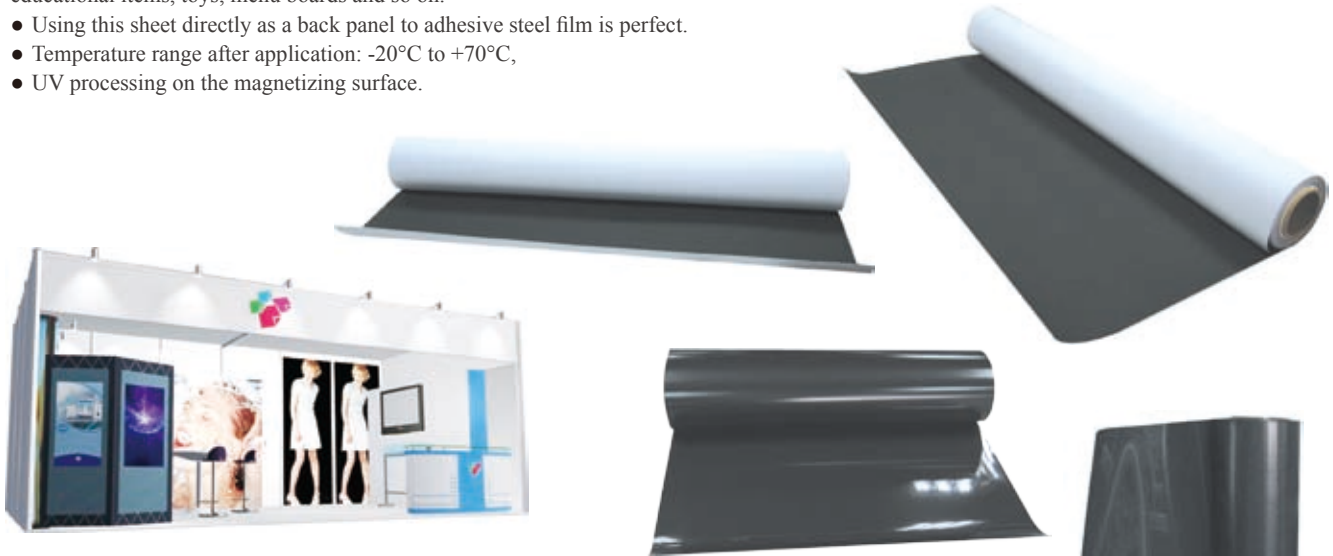
**▼ Samples****▼ Specifications**

Name	Model	Main Configurations	Length	Price
Printable Media Plain Brown Flexible Magnet	SIC-Y04-PB	Thickness: 0.3mm Width: 24" / 24.4" / 39.4"	32.8Y (30m)	\$6.65 / sq. m
Printable Media Matte Car Magnet	SIC-Y04-WMPVC-075	Thickness: 0.5 - 1.0mm, 0.75 or 0.8mm is recommended. Width: 24" / 39.4" / 51"	32.8Y (30m)	\$7.95 / sq. m
Printing Media Flexible Magnet with PVC	SIC-Y04-PVC	Thickness: 0.3mm - 2mm Width: 24" / 24.4" / 39.4"	32.8Y (30m)	\$6.65 / sq. m
Printable Flexible Magnet with Self Adhesive	SIC-Y04-PSA	Thickness: 0.3mm - 2mm Width: 24" / 24.4" / 39.4"	32.8Y (30m)	\$6.65 / sq. m

**▼ How to display**

## Cold Laminating Film

This kind of cold laminating film is clear PVC film with acrylic pressure sensitive adhesive for backing up the picture.

It mainly focuses on the usage of protecting the graphics without getting smudged, dirty, scratch or wet.

The process without destroying heat sensitive papers makes it widely used on laminating graphics and designs, such as personal photos, advertisement pictures.

The back base paper has two kind of color: White and yellow.

**About Price:** The price of advertising material products list on this book is the third ladder price.



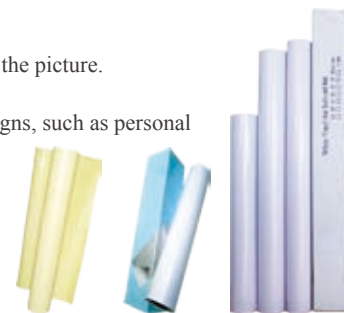







You can visit our website [www.sign-in-china.com](http://www.sign-in-china.com) for reference.



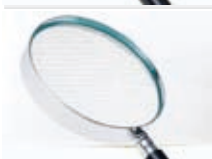

### ▼ Specifications (Quotation according to sq. m)

Picture	Name	Model	Description	Size	Price
	Glossy Transparent Cold Laminating Film	CS-CLF-Glossy	Glossy is an everyday film that will adhere to most ink lay downs. Glossy gives your picture a glass - like appearance.	25", 36", 50" / 30m	\$1.48 / sq. m
	Matte Rough Frost Cold Laminating Film	CS-CLF-R-Frost	The surface is rough frost.	25", 36", 50" / 30m	\$1.48 / sq. m
	Matte Cloth Bound Cold Laminating Film	CS-CLF-CLOTH-001	The surface is clothbound texture style.	25", 50" / 50m	\$1.48 / sq. m
	Matte Cloth Bound Cold Laminating Film	CS-CLF-CLOTH-1	The surface is clothbound texture style.	25", 36", 50" / 30m	\$1.48 / sq. m
	Matte Cross Texture Cold Laminating Film	CS-CLF-Cross-1	The surface is cross texture.	25", 36", 50" / 30m	\$1.48 / sq. m
	Matte Cross Texture Cold Laminating Film	CS-CLF-Cross	The surface is cross texture.	25", 36", 50" / 30m	\$1.48 / sq. m
	Matte Diamond Cold Laminating Film	CS-CLF-Diamond	The surface is diamond texture style.	25", 36", 50" / 30m	\$1.48 / sq. m
	Matte Frosted Cold Laminating Film	CS-CLF-L-Frosted	The surface with small frost has a slightly granular texture that is frosted to reduce glare.	25", 36", 50" / 30m	\$1.48 / sq. m

## &gt; Materials and Inks &gt; Laminating film &gt; cold laminating film

Picture	Name	Model	Description	Size	Price
	Glossy Laser Cold Laminating Film	CS-CLF-Laser	The surface is laser texture style, and there are many laser shapes, such as heat shape, leaf shape, dot shape and others.	25", 36", 50" / 30m	\$1.48 / sq. m
	Matte Leather Cold Laminating Film	CS-CLF-Leather	The surface with leather texture.	25", 36", 50" / 30m	\$1.48 / sq. m
	Matte Lozenge Diamond Cold Laminating Film	CS-CLF-Lozenge Diamond	The surface is Lozenge Diamond texture style. The picture will be more attractive when covered with this kind of laminating film.	25", 36", 50" / 30m	\$1.48 / sq. m
	Matte Magic Star Cold Laminating Film	CS-CLF-Magic Star	The surface is magic star texture.	25", 36", 50" / 30m	\$1.48 / sq. m
	Matte Marble Silk Cold Laminating Film	CS-CLF-Marble Silk	The surface is marble silk texture.	25", 36", 50" / 30m	\$1.48 / sq. m
	Matte Silk Cold Laminating Film	CS-CLF-Silk	The surface is silk texture.	25", 36", 50" / 30m	\$1.48 / sq. m
	Glossy Cold Laminating Film	BS-ZY-LAM-190G	Glossy is an everyday film that will adhere to most ink lay downs. Glossy gives your picture a glass - like appearance.	36", 42", 50", 54", 60" / 30m	\$3.24 / sq. m
	Cold Laminating PVC Film (160g)	BS-ZY-LAM-160G	The surface is matte and glossy available.	36", 42", 50", 54", 60" / 30m	\$1.68 / sq. m
	Cold Laminating PVC Film (140g)	BS-ZY-LAM-140G	The surface is matte and glossy available.	36", 42", 50", 54", 60" / 30m	\$1.55 / sq. m
	Cold Laminating PVC Film (120g)	BS-ZY-LAM-120G	The surface is matte and glossy available.	36", 42", 50", 54", 60" / 30m	\$1.42 / sq. m

## &gt; Materials and Inks &gt; Laminating film &gt; cold laminating film

Picture	Name	Model	Description	Size	Price
	Cold Laminating PVC Film (100g)	BS-ZY-LAM-100G	The surface is matte and glossy available.	36", 42", 50", 54", 60" / 30m	\$1.01 / sq. m
	Floor Membrane	BS-ZY-LAM-220		36", 42", 50", 54", 60" / 30m	\$2.02 / sq. m

## ▼ Specifications (Quotation according to roll) Length: 30m / roll

Name	Series	Code	Width	Length / roll	Price
Glossy Cold Laminating Film (UV resistant)	BS-ZY-LAM-190G	BS-ZY-LAM-190G-36R	36" (0.914m)	30m	\$88.75 / roll
		BS-ZY-LAM-190G-42R	42" (1.07m)	30m	\$103.91 / roll
		BS-ZY-LAM-190G-50R	50" (1.27m)	30m	\$123.33 / roll
		BS-ZY-LAM-190G-54R	54" (1.37m)	30m	\$133.04 / roll
		BS-ZY-LAM-190G-60R	60" (1.52m)	30m	\$147.6 / roll
Cold Laminating PVC Film (160g)	BS-ZY-LAM-160G	BS-ZY-LAM-160G-36R	36" (0.914m)	30m	\$46.15 / roll
		BS-ZY-LAM-160G-42R	42" (1.07m)	30m	\$54.3 / roll
		BS-ZY-LAM-160G-50R	50" (1.27m)	30m	\$64.13 / roll
		BS-ZY-LAM-160G-54R	54" (1.37m)	30m	\$69.18 / roll
Cold Laminating PVC Film (140g)	BS-ZY-LAM-140G	BS-ZY-LAM-140G-36R	36" (0.914m)	30m	\$76.75 / roll
		BS-ZY-LAM-140G-42R	42" (1.07m)	30m	\$42.60 / roll
		BS-ZY-LAM-140G-50R	50" (1.27m)	30m	\$49.88 / roll
		BS-ZY-LAM-140G-54R	54" (1.37m)	30m	\$59.20 / roll
Cold Laminating PVC Film (120g)	BS-ZY-LAM-120G	BS-ZY-LAM-120G-36R	36" (0.914m)	30m	\$63.85 / roll
		BS-ZY-LAM-120G-42R	42" (1.07m)	30m	\$70.85 / roll
		BS-ZY-LAM-120G-50R	50" (1.27m)	30m	\$39.06 / roll
		BS-ZY-LAM-120G-54R	54" (1.37m)	30m	\$45.72 / roll
Cold Laminating PVC Film (100g)	BS-ZY-LAM-100G	BS-ZY-LAM-100G-36R	36" (0.914m)	30m	\$54.27 / roll
		BS-ZY-LAM-100G-42R	42" (1.07m)	30m	\$58.53 / roll
		BS-ZY-LAM-100G-50R	50" (1.27m)	30m	\$64.94 / roll
		BS-ZY-LAM-100G-54R	54" (1.37m)	30m	\$27.69 / roll
Floor Membrane	BS-ZY-LAM-220	BS-ZY-LAM-220G-36R	36" (0.914m)	30m	\$32.42 / roll
		BS-ZY-LAM-220G-42R	42" (1.07m)	30m	\$38.47 / roll
		BS-ZY-LAM-220G-50R	50" (1.27m)	30m	\$41.51 / roll
		BS-ZY-LAM-220G-54R	54" (1.37m)	30m	\$46.05 / roll
Floor Membrane	BS-ZY-LAM-220	BS-ZY-LAM-220G-36R	36" (0.914m)	30m	\$55.38 / roll
		BS-ZY-LAM-220G-42R	42" (1.07m)	30m	\$64.84 / roll
		BS-ZY-LAM-220G-50R	50" (1.27m)	30m	\$76.96 / roll
		BS-ZY-LAM-220G-54R	54" (1.37m)	30m	\$83.01 / roll
Floor Membrane	BS-ZY-LAM-220	BS-ZY-LAM-220G-36R	36" (0.914m)	30m	\$92.10 / roll
		BS-ZY-LAM-220G-42R	42" (1.07m)	30m	
		BS-ZY-LAM-220G-50R	50" (1.27m)	30m	
		BS-ZY-LAM-220G-54R	54" (1.37m)	30m	

## &gt; Materials and Inks &gt; Laminating film &gt; cold laminating film

Name	Series	Code	Width	Length / roll	Price
Glossy Transparent Cold Laminating Film	CS-CLF-Glossy	CS-CLF-Glossy-25R	25" (0.635m)	30m	\$28.12 / roll
		CS-CLF-Glossy-36R	36" (0.914m)	30m	\$40.48 / roll
		CS-CLF-Glossy-50R	50" (1.27m)	30m	\$56.24 / roll
Matte Rough Frost Cold Laminating Film	CS-CLF-R-Frost	CS-CLF-R-Frost-25R	25" (0.635m)	30m	\$28.12 / roll
		CS-CLF-R-Frost-36R	36" (0.914m)	30m	\$40.48 / roll
		CS-CLF-R-Frost-50R	50" (1.27m)	30m	\$56.24 / roll
Matte Cloth Bound Cold Laminating Film	CS-CLF-ClothBound-001	CS-CLF-CLOTH-1-25R	25" (0.635m)	30m	\$28.12 / roll
		CS-CLF-CLOTH-1-36R	36" (0.914m)	30m	\$40.48 / roll
		CS-CLF-CLOTH-1-50R	50" (1.27m)	30m	\$56.24 / roll
Matte Cloth Bound Cold Laminating Film	CS-CLF-ClothBound-1	CS-CLF-CLOTH-001-25R	25" (0.635m)	30m	\$28.12 / roll
		CS-CLF-CLOTH-001-36R	36" (0.914m)	30m	\$40.48 / roll
		CS-CLF-CLOTH-001-50R	50" (1.27m)	30m	\$56.24 / roll
Matte Cross Texture Cold Laminating Film	CS-CLF-Cross-1	CS-CLF-Cross-1-25R	25" (0.635m)	30m	\$28.12 / roll
		CS-CLF-Cross-1-36R	36" (0.914m)	30m	\$40.48 / roll
		CS-CLF-Cross-1-50R	50" (1.27m)	30m	\$56.24 / roll
Matte Cross Texture Cold Laminating Film	CS-CLF-Cross	CS-CLF-Cross-25R	25" (0.635m)	30m	\$28.12 / roll
		CS-CLF-Cross-36R	36" (0.914m)	30m	\$40.48 / roll
		CS-CLF-Cross-50R	50" (1.27m)	30m	\$56.24 / roll
Matte Diamond Cold Laminating Film	CS-CLF-Diamond	CS-CLF-Diamond-25R	25" (0.635m)	30m	\$28.12 / roll
		CS-CLF-Diamond-36R	36" (0.914m)	30m	\$40.48 / roll
		CS-CLF-Diamond-50R	50" (1.27m)	30m	\$56.24 / roll
Matte Frosted Cold Laminating Film	CS-CLF-L-Frosted	CS-CLF-L-Frosted-25R	25" (0.635m)	30m	\$28.12 / roll
		CS-CLF-L-Frosted-36R	36" (0.914m)	30m	\$40.48 / roll
		CS-CLF-L-Frosted-50R	50" (1.27m)	30m	\$56.24 / roll
Glossy Laser Cold Laminating Film	CS-CLF-Laser	CS-CLF-Laser-25R	25" (0.635m)	30m	\$28.12 / roll
		CS-CLF-Laser-36R	36" (0.914m)	30m	\$40.48 / roll
		CS-CLF-Laser-50R	50" (1.27m)	30m	\$56.24 / roll
Matte Leather Cold Laminating Film	CS-CLF-Leather	CS-CLF-Leather-25R	25" (0.635m)	30m	\$28.12 / roll
		CS-CLF-Leather-36R	36" (0.914m)	30m	\$40.48 / roll
		CS-CLF-Leather-50R	50" (1.27m)	30m	\$56.24 / roll
Matte Lozenge Diamond Cold Laminating Film	CS-CLF-Lozenge Diamond	CS-CLF-LozengeDiamond-25R	25" (0.635m)	30m	\$28.12 / roll
		CS-CLF-LozengeDiamond-36R	36" (0.914m)	30m	\$40.48 / roll
		CS-CLF-LozengeDiamond-50R	50" (1.27m)	30m	\$56.24 / roll
Matte Magic Star Cold Laminating Film	CS-CLF-Magic Star	CS-CLF-MagicStar-25R	25" (0.635m)	30m	\$28.12 / roll
		CS-CLF-MagicStar-36R	36" (0.914m)	30m	\$40.48 / roll
		CS-CLF-MagicStar-50R	50" (1.27m)	30m	\$56.24 / roll
Matte Marble Silk Cold Laminating Film	CS-CLF-Marble Silk	CS-CLF-MarbleSilk-25R	25" (0.635m)	30m	\$28.12 / roll
		CS-CLF-MarbleSilk-36R	36" (0.914m)	30m	\$40.48 / roll
		CS-CLF-MarbleSilk-50R	50" (1.27m)	30m	\$56.24 / roll
Matte Silk Cold Laminating Film	CS-CLF-Silk	CS-CLF-Silk-25R	25" (0.635m)	30m	\$28.12 / roll
		CS-CLF-Silk-36R	36" (0.914m)	30m	\$40.48 / roll
		CS-CLF-Silk-50R	50" (1.27m)	30m	\$56.24 / roll



## CS-CLF-WF Series Window Flower Self Adhesive Film

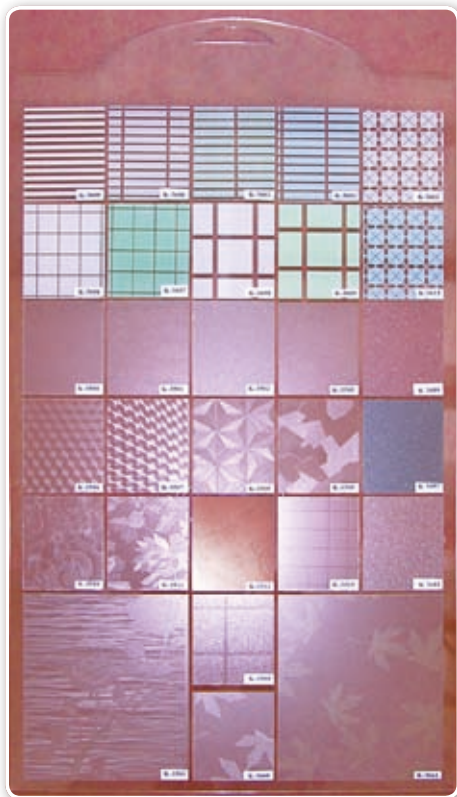

Used for glass window, door, wall's decoration  
 Pressed lines and pressed flowers in the surface  
 Removable type glue  
 Matte and glossy be provided.

### ▼ Specifications

**Available sizes:** 45cm x 15m (17.7" x 5.9"), 90cm x 15m (35.4" x 5.9"), 122cm x 50m (48" x 19.7"), 60cm x 50m (23.6" x 19.7")

**Thickness: Surface (PVC):** 80mic and 100mic

**Pad paper:** 80g / sq. m, 90g / sq. m, 120g / sq. m and 150g / sq. m

**Price: \$0.81 / sq. m**

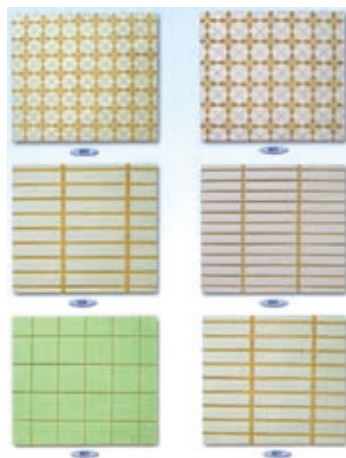

## SUPER TRANSPARENT DOUBLE SIDES Tape

**Model:** CS-CLF-TR-Double sides tape

Be used to the field of 3D picture production, adhesive of AD film.

### ▼ Product Highlights

Tick the picture of two - side transparent figure, making transparent handicraft production features:

- High degree of transparency. Better transparency and clearness than old production.
- Naked eye can not see the existence of it and also eliminate the opaque of the glue.
- Even if you pause when pull the surface, no trace left. So it makes your working effect better.

### ▼ Specifications

**Size:** 36", 42", 50", 54", 60" (0.914m, 1.07m, 1.27m, 1.37m, 1.52m)

**Price: \$1.70 / sq. m**



Name	Series	Code	Width	Length / roll	Price
		BS-ZY-DSA-09-36R	36" (0.914m)	30m	\$46.92 / roll
		BS-ZY-DSA-09-42R	42" (1.07m)	30m	\$54.85 / roll
Super Transparent Double Side Tape	CS-CLF-TR	BS-ZY-DSA-09-50R	50" (1.27m)	30m	\$65.10 / roll
		BS-ZY-DSA-09-54R	54" (1.37m)	30m	\$70.23 / roll
		BS-ZY-DSA-09-60R	60" (1.52m)	30m	\$77.84 / roll

## Thermal Laminating Film BOPP

It can be widely used in pictorial magazine, exquisite paper, colorful box, swinging signboard, and the package of medicine, cigarette and wine. Thermal Laminating Film BOPP adopts advanced producing craft and advanced technology of the composite materials.

- The product can solve the problems of pollution, safety and quality existed in the former materials.
- It has no poison or strange smell when using.
- No solvent is used which makes it more safe.
- It is also excellent for cementing. Besides, it is folding - resisting and press - resisting.
- And it has high adaptability, easy to operate.
- Smearing latex quantity is middle.
- It can stick well and prevent the paper from folding and pressing.
- There is no solvent thus hard to catch fire.
- Meet the standard of the cleanness of food package.
- The products are luster with good saturation.
- It can stick to all kinds of paper products, paper and aluminum composite materials and paper - like substances.



### ▼ Specifications

The width can be cut according to customer's requirement.

**MOQ:** 50kg

**Width:** 200mm - 1520mm

**Length:** 1000m - 3000m / roll

**Thickness:** 20mic - 30mic, glossy or matte

**Price:** \$4.62 / kg

**About Price:** The price of advertising material products list on this book is the third ladder price. You can visit our website [www.sign-in-china.com](http://www.sign-in-china.com) for reference.

## Advertisement Grade Reflective Sheeting

Advertisement grade reflective sheeting is a fabric with particular resin embedded with micro glass balls, with high reflecting rate manufactured with the technology of micro grade precision and can reflect backward incident rays.

- **Surface film:** a) Reflective glossy PET film (CRF01 - CRF06)  
b) Reflective glossy acrylic film (CRF11 - CRF16)
- **Adhesive:** Solvent based clear removable acrylic
- **Release Linear:** PE coated paper (130gsm)
- **Outdoor Durability:** 3 years
- **Standard Size:** 1.22m x 45.7m
- **Available Color:** 7 colors (red, white, yellow, green, blue, orange, black)

**Major Product and Services:** Various digital printing flex media for outdoor advertisement, billboards and indoor advertisement use.

**About Price:** The price of advertising material products list on this book is the third ladder price. You can visit our website [www.sign-in-china.com](http://www.sign-in-china.com) for reference.



### ▼ Specifications

Series	Feature	Available Color	Thickness	Operation Temperature	Price
BS-TM3100	Untearable, easy operation, can be screen printed by PET type ink Surface Film: PET	White, yellow, red, green, blue, orange, black	0.27mm	5°C - 30°C	\$2.42 / sq. m
BS-TM3200	Tearable, good extensibility, can be screen printed and inkjet printed, excellent for computer cutting Surface Film: Acrylic	White, yellow, red, green, blue, orange, black	0.31mm	18°C - 28°C	\$2.60 / sq. m
BS-TM3200 Special Color	Light yellow, light purple, water blue, light green, pink, sky blue, violet, gold, light orange, mayan gold, yellow green, green blue, magenta				\$2.60 / sq. m
BS-TM3800	Untearable, easy operation, good for screen printing and inkjet printing Surface Film: PVC	White, yellow, red, green, blue, orange	0.40mm	5°C - 30°C	\$3.38 / sq. m

## Engineering Grade Reflective Sheeting

Engineer Grade Reflective series is a fabric with particular resin embedded with micro glass balls, with high reflecting rate manufactured with the technology of micro grade precision and can reflect backward incident rays.

- **Surface Film:** a) Reflective glossy PET film.  
b) Reflective glossy acrylic film.
- **Adhesive:** Solvent based clear removable acrylic
- **Release Linear:** PE coated paper (130gsm)
- **Standard Size:** 1m x 50m, 1.24m x 45.7m
- **Available Color:** 7 colors (Red, white, yellow, green, blue, orange, black)

**Major Product and Services:** Various digital printing flex media for outdoor advertisement, billboards and indoor advertisement use.

**About Price:** The price of advertising material products list on this book is the third ladder price. You can visit our website [www.sign-in-china.com](http://www.sign-in-china.com) for reference.



### ▼ Specifications

Series	Feature	Available Color	Thickness	Service Life	Operation Temperature	Price
BS-TM5100	Untearable, easy to operate, easy to cut, and can be screen printed by PET type ink. Surface Film: PET	White, yellow, red, green, blue, orange, brow, black	0.325mm	5 years	5°C - 30°C	\$5.47 / sq. m
BS-TM5200	Tearable, good extensibility, can be screen printed and inkjet printed, excellent for computer cutting Surface Film: Acrylic	White, yellow, red, green, blue, orange, brow, black	0.32mm	5 years	18°C - 28°C	\$5.95 / sq. m
BS-TM7200	Surface improved, untearable can be screen printed, easy operation and cutting Surface Film: PET	White, yellow, red, green, blue, orange	0.335mm	7 years	18°C - 28°C	\$7.45 / sq. m

## License Plate Grade Reflective Sheeting

### ▼ Specifications

Series	Feature	Available Color	Thickness	Service Life	Operation Temperature	Price
BS-TM8200	It includes BS-TM8200-SG and BS-TM8200-T, Tearable, good extensibility, long service life, flexibility, and good for pressing (BS-TM8200T series are excellent for iron). Surface Film: Acrylic	White, yellow, red, green, blue	0.355mm	8 years	18°C - 28°C	\$8.35 / sq. m

## High Intensity Grade Reflective Sheeting

High intensity grade reflective sheeting is a reflecting material, with exceptional sealing performance and weather ability, which is compounded of reflecting unit consisting of micro glass balls with special metal plating and macromolecular resin by international advanced technology.

- **Surface Film:** Reflective glossy acrylic film
- **Adhesive:** Solvent based clear removable acrylic
- **Release linear:** PE coated paper (130gsm)
- **Outdoor Durability:** 7 - 10 years
- **Standard Size:** 1.24m x 45.7m
- **Available Color:** 7 colors (Red, white, yellow, green, blue, brown, black)

**Major Product and Services:** Various digital printing flex media for outdoor advertisement, billboards and indoor advertisement use.



**About Price:** The price of advertising material products list on this book is the third ladder price. You can visit our website [www.sign-in-china.com](http://www.sign-in-china.com) for reference.

### ▼ Specifications

Series	Feature	Available Color	Thickness	Service Life	Operation Temperature	Price
BS-TM1800	Tearable, can be screen printed, long service life, high counter - reflectivity. Surface Film: Acrylic (Import from Japan). Acquire inspection certificate of ASTM and EN12899	White, yellow, red, green, blue, orange, brown	0.485 - 0.495mm	10 years	18°C - 28°C	\$16.74 / sq. m

### ▼ Samples



## Photo Luminescent Tape

The product is non - toxic, non - radioactive and has stable chemical properties.

In contrast to other product, this product has extremely low requirements for the stimulation light.

A degree of normal 25LX brightness can be a source of stimulation light.

Inside a building, the normal light degree can reach 500 - 600LX.

Therefore, sunshine as well as normal bulb light can be used as sources of stimulating light.

- Light green
- Pressure - sensitive type
- **Size:** 1.24m x 45.7m per roll.

The initial lighting source is 1000LX. Activating time is 15 minutes.

We can also make slant stripe reflective sheeting.

You should contact us if you want special color reflective sheeting.

**About Price:** The price of advertising material products list on this book is the third ladder price. You can visit our website [www.sign-in-china.com](http://www.sign-in-china.com) for reference.



### ▼ Specifications

Series	Feature	Available Color	Thickness	Service Life	Operation Temperature	Price
BS-FG301	PET type, glow up 5 hours, unprintable, untearable	The luminescent value at 5 seconds $\geq 4000$ mcd / m <sup>2</sup>	0.38mm	Indoor: 8 years outdoor: 5 years	5°C - 30°C	\$13.94 / sq. m
BS-FG302	Acrylic type, glow up 5 hours, unprintable, tearable	The luminescent value at 5 seconds $\geq 4000$ mcd / m <sup>2</sup>	0.345mm	Indoor: 8 years outdoor: 5 years	10°C - 30°C	\$15.81 / sq. m
BS-FG720	Acrylic type, glow up 10 hours, printable, tearable	The luminescent value at 5 seconds $\geq 10000$ mcd / m <sup>2</sup>	0.44mm	Indoor: 10 years outdoor: 7 years	5°C - 30°C	\$27.92 / sq. m

> Materials and Inks > Grommet & vinyl banner glue

▼ Schema:

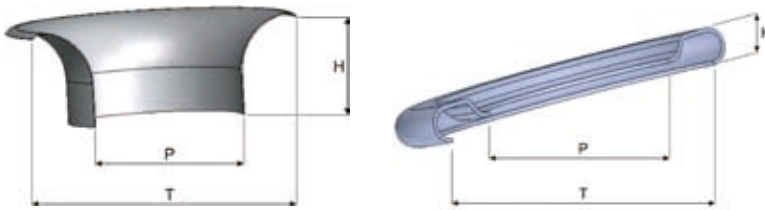

Remarks: T = Outer Diameter, P = Inner Diameter, H = Height

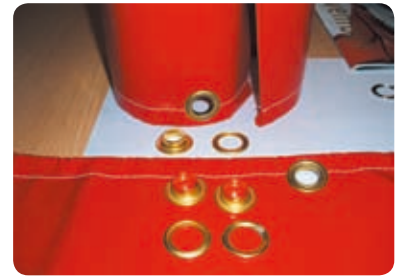

**CS-GM-IR4: 4# Grommet**

- Iron material, galvanization
- Various colors, silver, golden, etc
- Two parts, grommet and washer
- Qty / CTN: 10,000pcs / carton



▼ Specifications

Model	Grommet Size (mm)			Washer Size (mm)			Price
	T	P	H	T	P	H	
CS-GM-IR4	18.6	9.7	5.4	17.9	11	1.8	≤ \$63 / carton

**CS-GM-IR5: 5# Grommet**

- Iron material, galvanization
- Various colors, silver, golden, etc
- Two parts, grommet and washer
- Qty / CTN: 10,000pcs / carton



**CS-GM-IR6: 6# Grommet**

- Iron material, galvanization
- Various colors, silver, golden, etc
- Two parts, grommet and washer
- Qty / CTN: 10,000pcs / carton



▼ Specifications

Model	Grommet Size (mm)			Washer Size (mm)			Price
	T	P	H	T	P	H	
CS-GM-IR5	19.5	10	6.5	19	11	2	≤ \$181 / carton

▼ Specifications

Model	Grommet Size (mm)			Washer Size (mm)			Price
	T	P	H	T	P	H	
CS-GM-IR6	23	13	6.5	21	14	2.1	≤ \$184 / carton

**CS-GM-IR50: Iron Grommet**

- Iron material, galvanization
- Various colors, silver, golden, etc
- Two parts, grommet and washer
- Qty / CTN: 10,000pcs / carton



**CS-GM-IR70: Iron Grommet**

- Iron material, galvanization
- Various colors, silver, golden, etc
- Two parts, grommet and washer
- Qty / CTN: 10,000pcs / carton



▼ Specifications

Model	Grommet Size (mm)			Washer Size (mm)			Price
	T	P	H	T	P	H	
CS-GM-IR50	23	12	6.5	22.8	13	2	≤ \$96 / carton

▼ Specifications

Model	Grommet Size (mm)			Washer Size (mm)			Price
	T	P	H	T	P	H	
CS-GM-IR70	28	16	7.5	27	17	2.1	≤ \$172 / carton

**CS-GM-CO80: Copper Grommet**

- Copper material
- Various colors, silver, golden, etc
- Two parts, grommet and washer
- Qty / CTN: 10,000pcs / carton



**CS-GM-CO110: Copper Grommet**

- Copper material
- Various colors, silver, golden, etc
- Two parts, grommet and washer
- Qty / CTN: 10,000pcs / carton



▼ Specifications

Model	Grommet Size (mm)			Washer Size (mm)			Price
	T	P	H	T	P	H	
CS-GM-CO80	16	8	6.5	17	10	1	≤ \$681 / carton

▼ Specifications

Model	Grommet Size (mm)			Washer Size (mm)			Price
	T	P	H	T	P	H	
CS-GM-CO110	19	11	5	19	12	0.5	≤ \$960 / carton

## &gt; Materials and Inks &gt; Grommet &amp; vinyl banner glue

**CS-GM-CO135: Copper Grommet**

- Copper material
- Various colors, silver, golden, etc
- Two parts, grommet and washer
- Qty / CTN: 10,000pcs / carton



## ▼ Specifications

Model	Grommet Size (mm)			Washer Size (mm)			Price
	T	P	H	T	P	H	
CS-GM-CO135	23	13.5	5	23	14	0.5	≤ \$1,363 / carton

**CS-GM-AL130: Aluminum Grommet**

- Aluminum material
- Various colors, silver, golden, etc
- Two parts, grommet and washer
- Qty / CTN: 10,000pcs / carton



## ▼ Specifications

Model	Grommet Size (mm)			Washer Size (mm)			Price
	T	P	H	T	P	H	
CS-GM-AL130	22	13	7.5	22	14	1.5	≤ \$350 / carton

**CS-GM-PZ-P1:  $\varnothing$  12mm Plastic Grommet - No.1**

- PET material
- Inner Diameter: 12mm
- Various Colors: White
- Two Parts: Grommet and washer
- Qty / CTN: 10,000pcs / carton
- Applying grommet machine model: CS-GM-APD120, CS-GM-HED120-I

Price: ≤ \$433 / carton

**CS-GM-PZ-P2:  $\varnothing$  12mm Plastic Grommet - No.2**

- PC material
- Inner Diameter: 12mm
- Various Colors: White
- Two Parts: Grommet and washer
- Qty / CTN: 10,000pcs / carton
- Applying grommet machine model: CS-GM-HED120-I

Price: ≤ \$219 / carton

**CS-GM-PZ-M8:  $\varnothing$  8mm Iron Grommet**

- Iron material
- Inner Diameter: 8mm
- Various Colors: Silver, golden
- Two Parts: Grommet and washer
- Qty / CTN: 10,000pcs / carton
- Applying grommet machine model: CS-GM-HED120-II

Price: ≤ \$66 / carton

**CS-GM-PZ-M12:  $\varnothing$  12mm Iron Grommet**

- Iron material
- Inner Diameter: 12mm
- Various Colors: Silver, golden
- Two Parts: Grommet and washer
- Qty / CTN: 10,000pcs / carton
- Applying grommet machine model: CS-GM-HED120-III

Price: ≤ \$100 / carton

## OK201 Cyanoacrylate Adhesive - Super Bound

Item Code: ACC-AG-TQ-001

Price: \$2.41 / bottle 1.8oz (50g) / bottle

OK201 Powerful moment - then - bonding adhesives are widely used in plastic, rubber, metal, ceramic, timber, leather, stone, glass, diamonds, screw, electronic toys, automotive rubber edge, craft, inkjet printing cloth, etc.

- Ethyl cyanoacrylate, Single - component, Easy using, Strong viscosity
- No solvent added, Non - toxic, Non - combustible
- Slight boost flavor, Low - whitening



## New Three - Second Cyanoacrylate Adhesive

Item Code: ACC-AG-TQ-003

Price: \$1.06 / bottle 1.8oz (50g) / bottle

This kind of adhesive is widely used in PVC plastic material, inkjet printing, leather, ceramic, timber, jewelry, electronic toys, electrical component, handicrafts, automotive supplies, stationery, office supplies, etc.

- Ethyl cyanoacrylate, Single - component, Easy using, Strong viscosity
- No solvent added, Non - toxic, Non - combustible
- Slight boost flavor, Low - whitening



## 502 Cyanoacrylate Adhesive - Super Glue

Item Code: ACC-AG-TQ-002

Price: \$0.75 / bottle 0.7oz (20g) / bottle

502 Powerful moment - then - bonding adhesives are widely used in plastic, rubber, metal, ceramic, timber, leather, stone, glass, diamonds, screw, electronic toys, automotive rubber edge, craft, inkjet cloth, etc. Especially used for metal model.



## Special Glue for Acrylic

Item Code: ACC-AG-TQ-005

Price: \$6.39 / bottle 17.6oz (500g) / bottle

- Replaced the traditional CHCL3 adhesive.
- The sticking parts are all transparent, non - white border, no bubbles, no part - separating.
- Strong hold, bonding is stronger than CHCL3.
- Adhering point can be solid within 15 seconds.
- The adhesive flows fast and equally through the joint - face.
- The sawed borders should not be polished. Polishing effect can be achieved by brushing this product.

Using method: Conventional needle injecting or brushing

### Warning:

- If product gets in contact with your skin rinse with water
- Use in a ventilated environment
- Close after use, keep in a dark place





## > Materials and Inks > Grommet & vinyl banner glue



### UV Glue

**Item Code:** ACC-AG-TQ-006

**Price:** \$3.55 / bottle 0.4oz (10g) / bottle

Used for glass furniture, glass craft, crystal products, electronic industry, and optics equipment.

- Transparent, high strength
- Ten seconds to fix the position and 40 seconds to solidify under the UV lamp, high - pressure mercury lamp and sunlight.

#### Using method:

- Clean surface to remove grease.
- Coat surface with UV glue.
- Stick the surfaces and place under the UV lamp for appropriate time.

#### Warning:

- Avoid contact with eyes and skin, do not inhale.
- If product gets into your eyes rinse with water thoroughly and consult with your doctor.
- If product gets in contact with your skin rinse with water
- Keep in a dark and dry place under 25°C.

## Multi - purpose Double - Sided Tape

**Item Code:** CS-JC-DST-001

**Price:** \$10.80 / sq. m

It is mainly suitable for PVC banner, textile flag, roll up, PET film, glass, stainless and, acrylic sheets, etc.

**Size:** 0.4" x 1968.5" (1cm x 50m) / roll or 0.8" x 1968.5" (2cm x 50m) / roll. Other widths are available according to customer requirements.

The new alternative to glue, to avoid the inconvenience of transportation and application of glue, we are now launching a high - strength double - sided tape to meet the further requirements of customers.



- Tensile strength is up to 28n / 1" (25mm)
- Heat resistance is up to 120 degrees
- Anti - plasticizer, anti - UV
- Multi - purpose double - sided tape: compatible with different fabrics, and hard but smooth surfaces.
- Easy to use, convenient, and environmentally - friendly
- Compared with the traditional glue, this product is cleaner, stronger, more convenient, and environmentally friendly. The adhered images are smoother and more artistic.
- It can be used for other advertising purposes, like adhering canvas to sheet materials, or signage installation

#### Warning:

- Before using, please make sure the surface is clean: remove dust, oil, or water.
- Make sure the tape and the bonded parts are connected firmly.
- Choose the suitable width of the tape according to surface.
- Store in a dry environment

## Water Based Ink & Cartridge (Dye & Pigment)

### ▼ Specifications

Model	Name	Suitable Printer	Color	Volume	Price
<b>Water-LC-001</b>	Compatible Mutoh 1618 Dye Ink (DX5)	Mutoh RJ900, Mutoh 1604, Mutoh 1614, Mutoh 1618 water - base series printers	C, M, Y, K, LC, LM	1000ml / Bottle	≤ \$9.50 / L
Fast and excellent color stability, perfect color performance, dry fast.					
<b>HSI-HPI197680</b>	Compatible HPZ2100 / 6100 Water Based Pigment Ink	HP Z2100 / 6100 series printers	C, M, Y, LC, LM, LG, MK, PK	1000ml / Bottle	≤ \$83.80 / L
Fast and excellent color stability, perfect color performance. Mainly used for digital image field.					
<b>PGI-CNI-701</b>	700ML Compatible Canon701 Pigment Ink Cartridge	Canon iPF5000 / 5100 / 6100 series printers	C, M, Y, PC, PM, R, G, B, GY, PGY, MBK, BK	700ml / Cartridge	≤ \$64.70 / cartridge
Fast and excellent color stability, perfect color performance; pigment ink avoids color bleeding, and 12 colors, mainly for art reproduction field.					
<b>DBI-EPI-9800 cartridge</b>	Compatible Epson Stylus Pro 7800 / 9800 Pigment Ink Cartridge	Epson Stylus Pro 7800 / 9800 series printers	C, M, Y, K, LC, LM, LK, LLK	220ml / Cartridge	≤ \$28.40 / cartridge
High color saturation, vivid image color, IC chip is included, plug and play.					
<b>HSI-EPI198690</b>	Compatible Epson Pro7900 / 7910 / 9900 / 9910 Water Based Pigment Ink	Epson Stylus pro 7900 / 7910 / 9900 / 9910 series printers	C, VM, Y, PK, LC, VLM, LK, MK, LLK, OR, G	1000ml / Bottle	≤ \$60.00 / L
Preferred choice for Digital Image, Fine Art Reproduction, Decoration Industry, Digital proofing, etc.					
<b>PGI-EPI-006</b>	Compatible Epson Stylus7600 / 9600 Series Water Based Pigment Cartridge	Epson Stylus 7600 / 9600 series printers	C, M, Y, PK, LC, LM, LK	220ml / Cartridge	≤ \$28.30 / cartridge
High color saturation, IC chip is included, plug and play.					
<b>HSI-EPI198680-880</b>	Compatible Epson Pro 4880 / 7880 / 9880 / 11880 Pigment Ink	Epson Pro 4880 / 7880 / 9880 / 11880 series printers	C, VM, Y, PK, LC, LM, LK, MK, LLK	1000ml / Bottle	≤ \$64.70 / L
High color saturation, accurate color restoration, wide color range.					
<b>DBI-HPI-002-B</b>	Compatible HP DesignJet 5100 Dye Ink Cartridge	HP DesignJet 5100 series printers	C, M, Y, K, LC, LM	680ml / Cartridge	≤ \$29.17 / cartridge
IC chip is included, plug and play, vivid image color, 6 colors.					
<b>DBI-HPI-002-A</b>	Compatible HP DesignJet 5100 Dye Ink	HP DesignJet 5100 series printers	C, M, Y, K, LC, LM	1000ml / Bottle	≤ \$9.08 / L
Accurate color restoration, vivid image color, wide color range.					
<b>DBI-HPI-001-A</b>	Compatible HP DesignJet 5000 / 5500 Dye Ink	HP DesignJet 5000 / 5000PS / 5500 / 5500PS series printers	C, M, Y, K, LC, LM	1000ml / Bottle	≤ \$9.4 / L
Accurate color restoration, vivid image color, wide color range.					
<b>DBI-HPI-001-B</b>	Compatible HP DesignJet 5000 / 5500 Dye Ink Cartridge	HP DesignJet 5000 / 5000PS / 5500 / 5500PS series printers	C, M, Y, K, LC, LM	680ml / Cartridge	≤ \$30.5 / cartridge
Accurate color restoration, vivid image color, wide color range. IC chip is included, plug and play.					
<b>DBI-MII-021 / 022</b>	Compatible Mimaki JV2 / JV4 / JV22 Water Based Dye Ink	Mimaki JV2 / JV4 / JV22 series, other related Roland / Mutoh printers	C, M, Y, K, LC, LM	1000ml / Bottle	≤ \$8.75 / L
High color saturation, vivid image color.					
<b>DBI-MUI-019 / 020</b>	Compatible Mutoh RJ6000 / RJ8000 / RJ8100 Water Based Dye Ink	Mutoh RJ6000 / RJ8000 / RJ8100 series printers	C, M, Y, K, LC, LM	1000ml / Bottle	≤ \$8.75 / L
High color saturation, vivid image color.					

## &gt; Materials and Inks &gt; Inkjet ink &gt; water - based ink &amp; cartridge (dye &amp; pigment) //

Model	Name	Suitable Printer	Color	Volume	Price
<b>DBI-ROI-017 / 018</b>	Compatible Roland FJ540 / 740 Water Based Dye Ink	Roland FJ50 / Hi-Fi600 / 540 / 740 series printers	C, M, Y, K, LC, LM	1000ml / Bottle	≤ \$8.75 / L
High color saturation, vivid image color.					
<b>DBI-NVI-011</b>	Compatible Encad Nova750 Water Based Dye Ink	Encad Novajet series printers	C, M, Y, K	1000ml / Bottle	≤ \$6.2 / L
Fast dry after printing, very suitable for mass production.					
<b>DBI-NVI-011B</b>	Compatible Novajet750 Anti-UV Dye Ink	Encad Novajet series printers	C, M, Y, K	1000ml / Bottle	≤ \$7.62 / L
Fast dry after printing, very suitable for mass production. High anti - UV and UV absorbing ability.					
<b>HSI-HPI197660</b>	Compatible HP DesignJet 5000 / 5500 Pigment Ink	HP DesignJet 5000 / 5000PS / 5500 / 5500PS series printers	C, M, Y, K, LC, LM	1000ml / Bottle	≤ \$83.80 / L
Accurate color restoration, vivid image color, wide color range. Anti - UV ability and super resistance to water.					
<b>HSI-CNI-002</b>	Compatible Canon iPF5000 / 8000 / 9000 Water Based Pigment Ink	Canon iPF5000 / 8000 / 9000 iPF5100 / 6100 / 8100 iPF8000S / 9000S series printers	C, M, Y, PC, PM, R, G, B, GY, PGY, MBK, BK	1000ml / Bottle	≤ \$90.80 / L
Indoor durability of picture is more 50 years.					



DBI-HPI-002-B



DBI-HPI-002-B



DBI-HPI-001-B



DBI-EPI-9800 cartridge



DBI-EPI-006



PGI-CNI-701



HSI-CNI-002

## Solvent Ink

- Advanced raw materials ensure stability of ink quality.
- UV resistance superior or equal to the UV fading test required in the same environment and conditions.
- The fine grain brings easier inkjet printing and clogging - free applications.
- Diversiform programs of color combinations show you a wide color gamut and vivid images.
- Dry - fast inkjet prints give efficient productions.
- Environment - friendly inks bring you a better environment than inferior inks.



INFI-SK4



IWI-SpringI-SPT510



LMI-SoI-208U



UV-CRM-001



CBI-SoI-Konica14-A



IWI-SpringI-PQ512

### ▼ Specifications

Model	Name	Suitable Printhead	Color	Period of Outdoor Durability	Volume	Price
INFI-SK4	Infiniti SK4 Solvent Ink	Seiko SPT510	C, M, Y, K, LC, LM	12 months	5L / Bottle	≤ \$9.48 / L
IWI-KingI-128 / 126+	High Grade Xaar128 / 126 (360DPI) Printhead solvent Ink	Xaar-128 / 126 (360DPI)	C, M, Y, K, LC, LM	36 months	5L / Bottle	≤ \$12.18 / L
IWI-SpringI-128 / 126	Fragrance Xaar128 / 126 Printhead Solvent Ink	Xaar-128 / 126 (200DPI)	C, M, Y, K, LC, LM	18 months	5L / Bottle	≤ \$9.03 / L
IWI-SpringI-SPT510	Fragrance Seiko SPT510 Printhead Solvent Ink	Seiko SPT510	C, M, Y, K, LC, LM	18 months	5L / Bottle	≤ \$9.03 / L
IWI-SpringI-512-42PL	Fragrance Konica512-42PL Head Spring Solvent Ink	Konica 512-42PL	C, M, Y, K, LC, LM	18 months	5L / Bottle	≤ \$9.03 / L
IWI-SpringI-720	Fragrance Spectra Printhead Solvent Ink	Spectra Nova PH256 / 80	C, M, Y, K, LC, LM	18 months	5L / Bottle	≤ \$9.03 / L
IWI-SpringI-720S	Fragrance Spectra-s Printhead Solvent Ink	Spectra Skywalker 128 / 50	C, M, Y, K, LC, LM	18 months	5L / Bottle	≤ \$9.03 / L
CBI-SoI-Konica14-A	High Grade Konica14PL Printhead Solvent Ink	Konica-14PL printhead	C, M, Y, K	24 months	5L / Bottle	≤ \$12.17 / L
LMI-HMS-510	Low Odor Seiko510 Printhead Solvent Ink	Seiko SPT510	C, M, Y, K	24 months	5L / Bottle	≤ \$13.23 / L
LMI-SoI-507	Spectra Printhead Solvent Ink	Spectra printheads	C, M, Y, K	24 months	5L / Bottle	≤ \$12.17 / L
LMI-HMK-512	Low Odor Konica512 Printhead Solvent Ink	Konica printhead	C, M, Y, K	24 months	5L / Bottle	≤ \$13.23 / L
LMI-SoI-208U	High Grade Xaar128 Printhead Solvent Ink	Xaar 128 printhead	C, M, Y, K	24 months	5L / Bottle	≤ \$12.18 / L
LMI-CLE-211	Large Format Outdoor Printer Solvent Ink Cleaning Solution	All series of outdoor printers	Clear	18 months	5L / Bottle	≤ \$5.64 / L
UV-CRM-001	CRM Konica512 Printhead Flat and Soft UV Curable Ink	Konica printhead	C, M, Y, K, LC, LM, White, Clear	24 months	1L / Bottle	≤ \$85.9 / L
IWI-SpringI-PQ512	Fragrance Spectra PQ 512 Solvent Ink	Spectra PQ 512 / 35PL	C, M, Y, K, LC, LM	18 months	5L / Bottle	≤ \$10.03 / L

## ECO Inkjet Ink

### ▼ Specifications

Model	Name	Suitable Printer	Color	Volume	Price
<b>CAL-ECOCART-ROLAND220</b>	Calca Compatible 220ML Roland ECO - Sol Max. Ink Cartridge	Piezo head of Epson, Roland series, etc.	C, M, Y, K, LC, LM	220ml / Cartridge	≤ \$29.99 / Cartridge
220ml "Plug and Play" ink cartridge have IC chip, 6 colors, no need to change ICC Profile, can replace Roland ECO - Sol Max ink cartridge, less wear on the print heads, vibrant, brilliant colors. Excellent color gamut, broader substrate adaptation, color and density consistency between different batches, slightly smell with friendly to user and environment, 25 months outdoor durability without any coating.					
<b>CAL-ECOCART-ROLAND440</b>	Calca Compatible 440ML Roland ECO - Sol Max. Ink Cartridge	Piezo head of Epson, Roland series, etc.	C, M, Y, K, LC, LM	440ml / Cartridge	≤ \$44.99 / Cartridge
440ml "Plug and Play" ink cartridge have IC chip, 6 colors, no need to change ICC Profile, can replace Roland ECO - Sol Max ink cartridge, less wear on the print heads, vibrant, brilliant colors. Excellent color gamut, broader substrate adaptation, color and density consistency between different batches, slightly smell with friendly to user and environment, 25 months outdoor durability without any coating.					
<b>CAL-ECOCART-MIMAKI220</b>	Calca Compatible 220ML Mimaki ECO Ink Cartridge	Piezo head of Epson, Mimaki JV33 / JV3 / JV5 series, etc.	C, M, Y, K	220ml / Cartridge	≤ \$29.99 / Cartridge
220ml "Plug and Play" ink cartridge have Mimaki IC chip, 4 colors, no need to change ICC Profile, can replace Mimaki ECO ink cartridge, less wear on the print heads, vibrant, brilliant colors. Excellent color gamut, broader substrate adaptation, color and density consistency between different batches, slightly smell with friendly to user and environment, 25 months outdoor durability without any coating.					
<b>CAL-ECOCART-MIMAKI440</b>	Calca Compatible 440ML Mimaki ECO Ink Cartridge	Piezo head of Epson, Mimaki JV33 / JV3 / JV5 series, etc.	C, M, Y, K	440ml / Cartridge	≤ \$44.99 / Cartridge
440ml "Plug and Play" ink cartridge have Mimaki IC chip, 4 colors, no need to change ICC Profile, can replace Mimaki ECO ink cartridge, less wear on the print heads, vibrant, brilliant colors. Excellent color gamut, broader substrate adaptation, color and density consistency between different batches, slightly smell with friendly to user and environment, 25 months outdoor durability without any coating.					
<b>ECO-LC-CS01</b>	Solvent Ink Cleaning Solution (Bottle)	Use Piezo Head of Epson, like Roland, Mimaki, Mutoh, etc.	Clear	1000ml / Bottle	≤ \$18.70 / L
Safe cleaning liquid for solvent ink printers.					
<b>ECO-LC-CS02</b>	Solvent Ink Cleaning Solution (Cartridge)	Use Piezo Head of Epson, like Roland, Mimaki, Mutoh, etc.	Clear	220ml / Cartridge	≤ \$10.06 / Cartridge
Safe cleaning liquid for solvent ink printers. No chip, plug and play.					
<b>ECO-CHROMO-001</b>	Compatible Roland EAGLE ECO Ink (No ICC profile needed)	Roland / Mutoh / Mimaki series Seiko / Konica printhead series, etc.	C, M, Y, K, LC, LM	1000ml / Bottle	≤ \$65.30 / L
Slightly smell, suitable for piezoelectric printers, 6 color, bottle, water - proof and UV resistance, 24 months outdoor weather resistance, more than 15 months shelf time, no ICC profile needed, RoHS certification. <b>(Free shipping)</b>					
<b>ECO-440MLCART-WHITE</b>	White Compatible 440ML ECO Solvent Ink Cartridge (Epson DX4)	Roland wide inkjet printer and contour cutter in one device. Roland SJ Series, such as SJ-745EX, SJ-645 EX, SJ-540, SJ-640, SJ-740, SP-540, XC-540, XC-540MT, SC-545EXW. Can not be used on Epson DX5 printhead printers.	White	440ml / Cartridge	≤ \$78.20 / Cartridge
440ml White ECO cartridge ink slightly smell, suitable for Roland wide format inkjet printer / cutters. <b>(Free shipping)</b>					



CAL-ECOCART-ROLAND220



CAL-ECOCART-ROLAND440



ECO-LC-CS01

ECO-CHROMO-001



CAL-ECOCART-MIMAKI220



CAL-ECOCART-MIMAKI440



ECO-LC-CS02



ECO-440MLCART-WHITE

## The Process of Sublimation Printing

Sublimation Printing is a special printing technology that can print the portrait, landscape or any other images on the sublimation printing paper with the sublimation ink.

Then it can be heated up to certain temperature within several minutes by the heat transfer heating equipment.

The images on the paper will be transferred to textile fabric materials with vivid color.

### ▼ Features of Fabric

- Green and environment - friendly product. All the fabrics we provided are 100% recyclable materials, and the assorted sublimation ink we used is also green and environment - friendly.
- The printed picture is no irritating odor for using the green sublimation ink.
- The transferred picture is inviting and attractive for its vividness when breeze.
- The heat transfer materials are all ironed and pressed. Thus the surface is neat and smooth.
- The material is portable, so it's easy to take as a picture and convenient for packing and shipping.
- It's easy to fold without marks, great for the graphic effect.
- The transferred picture is durable, and will keep neat for long. Most materials are washable by washing machine, fast - drying and no fading.
- Great variety, more choices for you to meet your special requirement.



### ▼ Specifications

Name	Model	Description	GSM	Width	Price
Tribute Silk	BS-DYESUBLIMATION-01	This kind of premium tribute silk has glossy surface and of soft texture. It is widely used for making advertising screen.	180g	1.5m	\$2.15 / m
Knitting Cloth-110G	BS-DYESUBLIMATION-02	This kind of knitting cloth is lightweight, and of soft breathable texture. It is mainly used for making advertising screen.	110g	1.5m	\$1.54 / m
300D Oxford	BS-DYESUBLIMATION-03	This high quality 300D Oxford, of which width from 1.5m to 2.2m, has good drapability. It is applicable for making roll - up screen, banner, and so on.	160g	1.5m-2.2m	\$1.84 / m
Stage Design Silk	BS-DYESUBLIMATION-04	Stage Design Silk has glossy and smooth surface, which could yield a great effect. It is applicable for making advertising screen, stage background, etc.	170g	1.5m	\$2.00 / m
Pongee	BS-DYESUBLIMATION-05	This kind of premium pongee features lightweight, elegant and double sides penetrable by light. It is mainly used for making banners.	70g	1.5m	\$1.08 / m
Polyester Yarns	BS-DYESUBLIMATION-06	This kind of elegant polyester yarns is lightweight and of soft breathable texture, meantime it is penetrable by light. It is applicable for making drape, curtain picture.	50g	1.5m	\$1.08 / m
Knitting Cloth	BS-DYESUBLIMATION-07	This kind of knitting cloth has good drapability and it is flat and flexible. It is widely used for making pop - up display screen, background of signboard and so on.	240g	2.2m	\$3.83 / m
Mesh Knitting Cloth	BS-DYESUBLIMATION-08	The mesh knitting cloth has mesh surface thus has a good ventilate performance. It can be used in the places with strong wind for advertising. It can be used for making pop - up display screen, banner and so on.	145g	1.5m	\$1.84 / m
Silver Coating Fabric	BS-DYESUBLIMATION-09	The surface has been processed by silver coating thus makes it more attractive. It can be widely used for making pop - up display screen, banner and so on.	140g	1.5m	\$1.08 / m
Polar Fleece	BS-DYESUBLIMATION-10	This kind of polar fleece can be transferred on both sides. It is widely used for making hanging flag, wall pictures, etc.	280g	1.5m	\$3.83 / m

### ▼ Samples



**CS-HTP-SW327007: A4 Size Light Color T - Shirt Heat Transfer Paper**

Using waterbased pigment ink.

High quality and convenient to use.

Image can be printed by any desktop inkjet printer, like HP printer, Canon Printer, etc.

For transferring 100% cotton T - shirts or more than 60% cotton contained with light color.

**▼ Specifications**

Model	Size	Package	Price
CS-HTP-SW327007	210mm x 297mm (A4)	100 pcs / parcel	≤ \$70.74 / parcel

**CS-HTP-SW327008: A4 Size Dark Color T - Shirt Heat Transfer Paper**

Using waterbased pigment ink.

High quality and convenient to use.

Image can be printed by any desktop inkjet printer, like HP printer, Canon Printer, etc.

For transferring 100% cotton T - shirts or more than 60% cotton contained with light color.

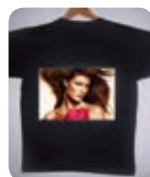
**▼ Specifications**

Model	Size	Package	Price
CS-HTP-SW327008	210mm x 297mm (A4)	100 pcs / parcel	≤ \$92.23 / parcel

**CS-HTP-jxl327003: A4 Size Sublimation Paper**

Using with sublimation ink.

Printed image by printer with piezo printhead like Epson printer.

High quality and convenient to use.

For transferring fiber T - shirts with light color, plates, mugs, caps, metal sheet, etc.

**▼ Specifications**

Model	Size	Package	Price
CS-HTP-jxl327003	210mm x 297mm (A4)	100 pcs / parcel	≤ \$14.88 / parcel

**CS-HTP-KY: Sublimation Paper (Roll)**

Fine flatness of surface

Outstanding ink fixations

Bright color under lighting or delighting

Printed image by printer with piezo printhead like Epson printer

Used for transferring mugs, cups, metals, also for caps and T - shirts made of fiber fabric, etc

Available sizes: 0.61 x 100m, 1.118m x 100m, 1.37m x 100m, 1.6m x 100m

**▼ Specifications**

Model	Size	Type	Price
CS-HTP-KY	0.914m x 100m (36" x 3937")	Roll	≤ \$0.93 / sq. m

## ▼ How to Operate

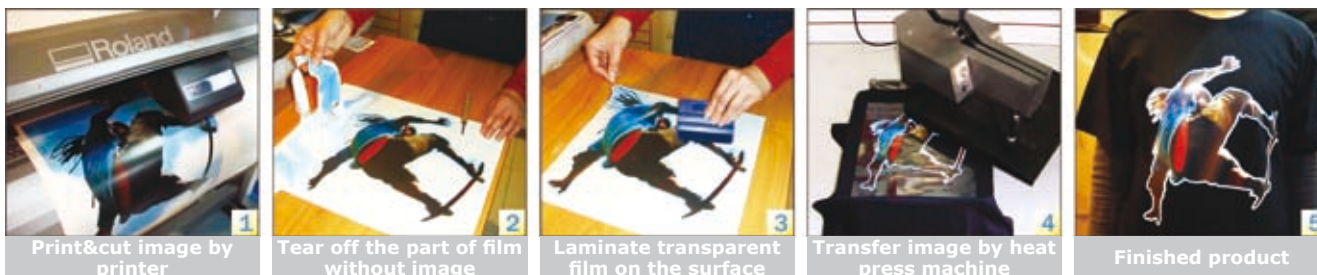

## HTF-PC-001 / 002: White - Color Print &amp; Cut Heat Transfer Vinyl

Widely used for personal T - shirt design, sports clothes design, uniform clothes, AD T - shirts, color flags, fabric bags, and leather, etc.

- Using ECO solvent ink
- PU material, using together with transparent transfer vinyl
- Image should be printed by print and cut printer, like Roland print and cut printer

## ▼ Specifications

Model	HTF-PC-001	HTF-PC-002
Size	61cm x 30m (24" x 1181") (Roll)	75cm x 30m (29.5" x 1181") (Roll)
Pressing Temperature	155°C	155°C
Pressing Time	15 sec	15 sec
<b>Price</b>	≤ \$152 / roll	≤ \$176 / roll



## HTF-PC-003 / 004: Silver - Color Print &amp; Cut Heat Transfer Vinyl



Widely used for personal T - shirt design, sports clothes design, uniform clothes, AD T - shirts, color flags, fabric bags, leather, etc.

- Using ECO solvent ink
- PU material, using together with transparent transfer vinyl
- Image should be printed by print and cut printer, such as Roland print and cut printer

## ▼ Specifications

Model	HTF-PC-003	HTF-PC-004
Size	61cm x 30m (24" x 1181") (Roll)	75cm x 30m (29.5" x 1181") (Roll)
Pressing Temperature	155°C	155°C
Pressing Time	15 sec	15 sec
<b>Price</b>	≤ \$204 / roll	≤ \$239 / roll

## HTF-PC-005 / 006: Application Tape

Using just for protecting the image printed on print and cut film

- White transparent, PET film
- Adhesive film on the back
- Using together with Print and cut transfer vinyl
- Can not be printed image or cut any shape individually

## ▼ Specifications

Model	HTF-PC-005	HTF-PC-006
Size	61cm x 30m (24" x 1181") (Roll)	75cm x 30m (29.5" x 1181") (Roll)
Pressing Temperature	155°C	155°C
Pressing Time	15 sec	15 sec
<b>Price</b>	≤ \$51 / roll	≤ \$59 / roll



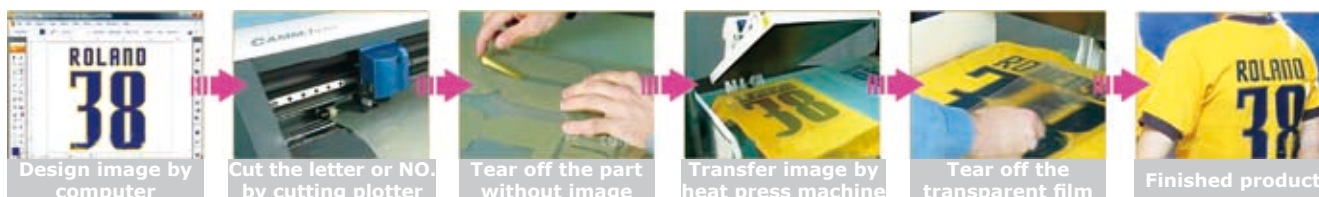

## ▼ How to Operate

**HTF-CUT-001: Standard Digital Cut Heat Transfer Vinyl**

Widely used for personal T - shirt design, sports clothes design, uniform clothes, AD T - shirts, color flags or mass production.

- PVC material and PET film on the surface
- It can be cut any shape and letter by cutting plotter
- **Available Colors:** White, yellow, blue, black, red, etc

## ▼ Specifications

Model	HTF-CUT-001
Size	50cm x 25m (19.7" x 984") (Roll)
Pressing Temperature	155°C
Pressing Time	15 sec
<b>Price</b>	≤ \$172 / roll

**HTF-CUT-002: Deluxe Digital Cut Heat Transfer Vinyl**

Widely used for personal T - shirt design, sports clothes design, uniform clothes, AD shirts, color flags, fabric bag, leather, etc.



- PU material and PET film on the surface
- More elastic film, easy to operate and great effect
- It can be cut any shape and letter by cutting plotter
- **Available Colors:** White, yellow, sky blue, black, red, neon yellow, orange, etc



High-quality

## ▼ Specifications

Model	HTF-CUT-002
Size	50cm x 25m (19.7" x 984") (Roll)
Pressing Temperature	165°C
Pressing Time	12-15 sec
<b>Price</b>	≤ \$190 / roll

**HTF-CUT-003: Metallic Cut Heat Transfer Vinyl**

Widely used for personal T - shirt design, sports clothes design, uniform clothes, AD shirts, color flags, fabric bag, leather, etc.

- Metallic film looks great when transferred on the T - shirts
- It's easy to operate with great effect
- It can be cut any shape and letter by cutting plotter
- **Available Colors:** Golden and silver

## ▼ Specifications

Model	HTF-CUT-003
Size	50cm x 25m (19.7" x 984") (Roll)
Pressing Temperature	130°C - 155°C
Pressing Time	12 sec
<b>Price</b>	≤ \$200 / roll



## ▼ Samples

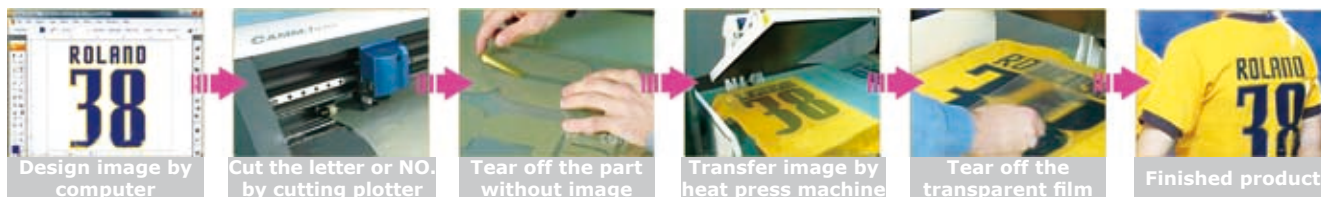

## ▼ How to Operate

**HTF-CUT-004: Neon Cut Heat Transfer Vinyl**

Widely used for personal T - shirt design, sports clothes design, uniform clothes, AD shirts, color flags, fabric bags, leather, etc.

- Neon film looks beautiful when transferred on the T - shirts
- It's easy to operate with great effect
- It can be cut any shape and letter by cutting plotter
- **Available Colors:** Neon yellow, neon orange, neon green, neon pink, etc

## ▼ Specifications

Model	HTF-CUT-004
Size	50cm x 25m (19.7" x 984") (Roll)
Pressing Temperature	130°C - 155°C
Pressing Time	12 sec
<b>Price</b>	≤ \$200 / roll

**HTF-CUT-005: Glitter Heat Transfer Vinyl**

Widely used for personal T - shirt design, sports clothes design, uniform clothes, AD shirts, color flags, fabric bags, leather, etc.

- Glitter heat transfer film
- It's easy to operate with great effect
- It can be cut any shape and letter by cutting plotter
- **Available Colors:** Red, light blue, purple, green, pink, golden, silver, etc

## ▼ Specifications

Model	HTF-CUT-005
Size	50cm x 50m (19.7" x 984") (Roll)
Pressing Temperature	155°C
Pressing Time	12 sec
<b>Price</b>	≤ \$402 / roll

**HTF-CUT-006: Reflective Heat Transfer Vinyl**

Widely used for personal T - shirt design, sports clothes design, uniform clothes, AD shirts, color flags, fabric bags, leather, etc.

- Reflection cutting film for traffic area
- It's easy to operate with great effect
- It can be cut any shape and letter by cutting plotter

## ▼ Specifications

Model	HTF-CUT-006
Size	50cm x 50m (19.7" x 984") (Roll)
Pressing Temperature	155°C
Pressing Time	12 sec
<b>Price</b>	≤ \$321 / roll

## ▼ Samples



## HTF-CUT-007: Flock Heat Transfer Vinyl

Widely used for personal T - shirt design, sports clothes design, uniform clothes, AD T - shirts, color flags, fabric bag, leather, etc.

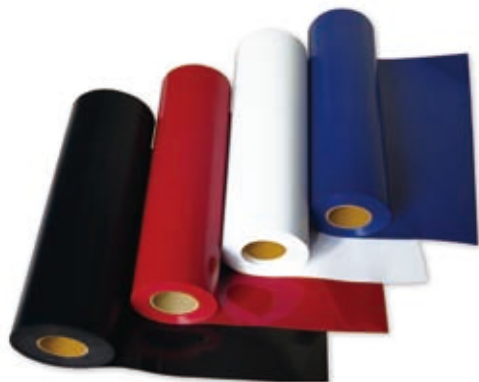

- Flock cutting vinyl
- It's easy to operate with great effect
- It can be cut any shape and letter by cutting plotter



### ▼ Specifications

Model	HTF-CUT-007
Size	50cm x 25m (19.7" x 984") (Roll)
Pressing Temperature	160°C - 170°C
Pressing Time	15 sec
<b>Price</b>	≤ \$272 / roll

### ▼ How to Operate

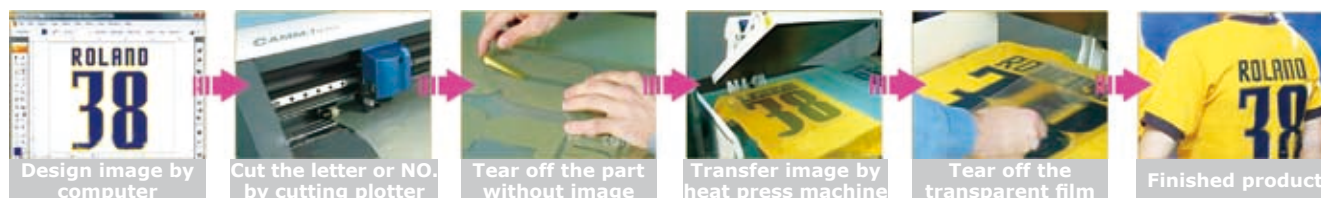

## HTF-CUT-008: Embroidery Heat Transfer Vinyl

Widely used for personal T - shirt design, sports clothes design, uniform clothes, AD T - shirts, color flags, fabric bag, leather, etc.

- Embroidery cutting vinyl
- It's easy to operate with great effect
- It can be cut any shape and letter by laser cutter

### ▼ Specifications

Model	HTF-CUT-008
Size	45cm x 10m (18" x 394") (Roll)
Pressing Temperature	160°C - 170°C
Pressing Time	30 sec
<b>Price</b>	≤ \$265 / roll



### ▼ How to Operate

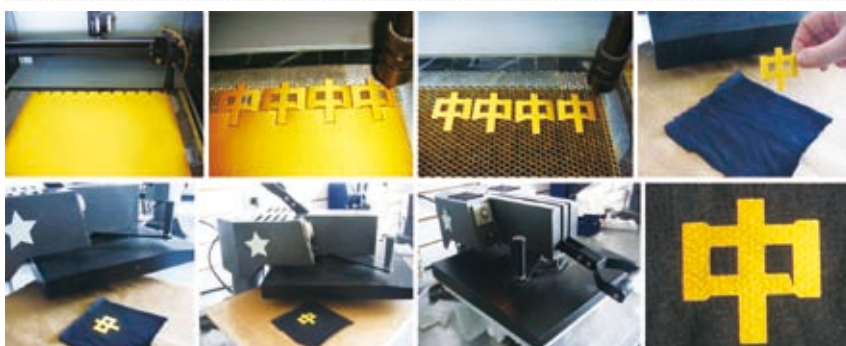

**HTC-SW01: Super White Blank Sublimation Mug**

- Super White & Superfine, 11OZ, ceramic
- **Diameter:** 8.2cm (3.2")
- **Height:** 9.6cm (3.8")
- **MOQ:** 36pcs
- **Unit Price:** ≤ \$1.17 / pc

**HTC-SM01: Superfine White Blank Sublimation Mug**

- White & Superfine, 11OZ, ceramic material
- **Diameter:** 8.2cm (3.2")
- **Height:** 9.6cm (3.8")
- **MOQ:** 36pcs
- **Unit Price:** ≤ \$1.05 / pc

**HTC-M02: Inside Colorful Superfine Sublimation Mug**

- Inside colorful & Superfine, 11OZ, ceramic material
- **Diameter:** 8.2cm (3.2")
- **Height:** 9.6cm (3.8")
- **MOQ:** 36pcs
- **Available Colors:** Black, green, light green, sapphire blue, light blue, yellow, light yellow and pink
- **Unit Price:** ≤ \$1.27 / pc

**HTC-M03: Sublimation Superfine Ceramic Mug with Colored Rim**

- Mugs with colorful rim & Superfine, 11OZ
- **Diameter:** 8.2cm (3.2")
- **Height:** 9.6cm (3.8")
- **MOQ:** 36pcs
- **Available Colors:** Black, sapphire blue, green, yellow, light green, blue, light blue, orange and light yellow
- **Unit Price:** ≤ \$1.27 / pc

**HTC-P-M: Partial Color Changing Mug**

- Partial changeable mug, 11OZ, ceramic material
- **Diameter:** 8.2cm (3.2")
- **Height:** 9.6cm (3.8")
- **MOQ:** 36pcs
- When poured into hot water (50°C~70°C), the colored part will get lighter and thus the picture could be seen gradually.
- **Unit Price:** ≤ \$2.02 / pc

**HTC-F-M: Full Body Color Changing Mug**

- Full changeable mug, 11OZ, ceramic material
- **Diameter:** 8.2cm (3.2")
- **Height:** 9.6cm (3.8")
- **MOQ:** 36pcs
- Printing image would be seen gradually when put hot water into the mug
- **Unit Price:** ≤ \$3.99 / pc

**HTC-AM11oz: Sublimation Ceramic Mug with Animal Handle**

- Blank mug with animal handle, 11OZ
- **Diameter:** 8.2cm (3.2")
- **Height:** 9.6cm (3.8")
- **MOQ:** 36pcs
- White body with colorful body and kinds of animal handle
- **Unit Price:** ≤ \$2.36 / pc

**HTC-CO-M: Sublimation Coffee Cup**

- White sublimation coffee cup, ceramic material
- **Diameter:** 7.8cm (3.1")
- **Height:** 5.3cm (2.1")
- **MOQ:** 36pcs
- The coffee cup is sold together with a spoon and a saucer
- **Unit Price:** ≤ \$3.68 / pc

**HTC-M04: White Ceramic Lovers Mugs**

- Lovers' mug with heart shape handle, 11OZ
- **Diameter:** 8.2cm (3.2")
- **Height:** 9.6cm (3.8")
- **MOQ:** 24pcs
- **Unit Price:** ≤ \$1.85 / pc

**HTC-M-Z: Cone Sublimation White Mug**

- Cone white sublimation ceramic mug, 12OZ
- **Diameter:** Up: φ9cm (3.5")
- **Bottom:** φ6.1cm (2.4")
- **Height:** 9.8cm (3.9")
- **MOQ:** 36pcs
- **Unit Price:** \$1.92 / pc

**HTC-G-P1: Sublimation Ceramic Bear Mug**

- White Sublimation Bear Mug, 12OZ
- **Diameter:** 7.7cm (3")
- **Height:** 16cm (6.3")
- **MOQ:** 24pcs
- **Unit Price:** ≤ \$3.79 / pc

**HTC-M14SS: Stainless Steel Sublimation Mug**

- Stainless Steel Mug, 14OZ
- Made of high quality stainless steel
- **MOQ:** 48pcs
- **Unit Price:** ≤ \$4.43 / pc



**HTP-P802: White Ceramic Sublimation Plate (8 inch)**

- Super white, high glossy, smooth surface
- **Transferring Diameter:** 13.5cm (5.3")
- **MOQ:** 36pcs
- **Unit Price:** ≤ \$2.14 / pc

**HTP-P1001: White Ceramic Sublimation Plate (10 inch)**

- Super white, high glossy, smooth surface
- **Transferring Diameter:** 16.5cm (6.5")
- **MOQ:** 36pcs
- **Unit Price:** ≤ \$3.22 / pc

**HTMP-MKG2: Sublimation Metal Plate (8 inch)**

- Strawberry design edge, metal material
- **Transferring Diameter:** 12cm (4.72")
- **MOQ:** 50pcs
- **Unit Price:** ≤ \$4.12 / pc

**HTMP-MKG3: Sublimation Metal Plate (10 inch)**

- Round edge, metal material
- **Transferring Diameter:** 15cm (5.90")
- **MOQ:** 50pcs
- **Unit Price:** ≤ \$6.88 / pc

**HTP-CA: Sublimation Caps**

- White sublimation cap, fiber fabric material
- **MOQ:** 100pcs
- **Unit Price:** ≤ \$1.40 / pc

**HTMO-MKG3: Sublimation Mouse Pad**

- Silica gel as basic material and cloth as the surface
- **Size:** 220mm x 180mm x 3mm (8.7" x 7.1" x 0.12")
- **MOQ:** 50pcs
- A variety of shapes for your choice
- **Unit Price:** ≤ \$0.79 / pc

**HTPI-P11: Sublimation Pillowcase**

- Made of high quality silk
- Blank area for heat transferring
- **Size:** 400mm x 400mm (15.7" x 15.7")
- **MOQ:** 50pcs
- **Colors:** Red, purplish red, golden, brown, green, blue
- **Unit Price:** ≤ \$2.52 / pc

**HTCM-MKK: Sublimation Cosmetic Mirror**

- Stainless steel surface
- Blank area for heat transferring
- **MOQ:** 100pcs
- A variety of shapes for your choice
- **Unit Price:** ≤ \$1.16 / pc



**CS-PH-3D4: 3D Iphone 4 Protection Shell**

- **Color:** White
- **Material:** Polymer
- PP bag package
- **MOQ:** 500pcs
- **Unit Price:** ≤ \$0.59 / pc

**CS-PH-3D4S: 3D Iphone 4S Protection Shell**

- **Color:** White
- **Material:** Polymer
- PP bag package
- **MOQ:** 500pcs
- **Unit Price:** ≤ \$0.59 / pc

**CS-PH-3D5: 3D Iphone 5 Protection Shell**

- **Color:** White
- **Material:** Polymer
- PP bag package
- **MOQ:** 500pcs
- **Unit Price:** ≤ \$0.60 / pc

**CS-PH-3DS3: 3D Samsung S3 9300 Protection Shell**

- **Color:** White
- **Material:** Polymer
- PP bag package
- **MOQ:** 500pcs
- **Unit Price:** ≤ \$0.59 / pc

**CS-PH-3DN2: 3D Samsung Note2 7200 Protection Shell**

- **Color:** White
- **Material:** Polymer
- PP bag package
- Work with Note2 7200 mould
- **MOQ:** 500pcs
- **Unit Price:** ≤ \$0.64 / pc

**CS-PH-3DH1X: 3D HTC one x Protection Shell**

- **Color:** White
- **Material:** Polymer
- PP bag package
- Work with HTC one X mould
- **MOQ:** 500pcs
- **Unit Price:** ≤ \$0.64 / pc

**CS-PAD-3DMN: 3D Ipad mini Protection Shell**

- **Color:** White
- **Material:** Polymer
- PP bag package
- Work with Mini Pad mould
- **MOQ:** 200pcs
- **Unit Price:** ≤ \$1.81 / pc

**CS-PAD-3D-I: 3D Ipad2 Protection Shell**

- **Color:** White
- **Material:** Polymer
- PP bag package
- Work with Ipad2 mould
- **MOQ:** 100pcs
- **Unit Price:** ≤ \$2.72 / pc

**CS-PAD-3D-II: 3D Ipad3 Protection Shell**

- **Color:** White
- **Material:** Polymer
- PP bag package
- Work with Ipad3 mould
- **MOQ:** 100pcs
- **Unit Price:** ≤ \$2.72 / pc

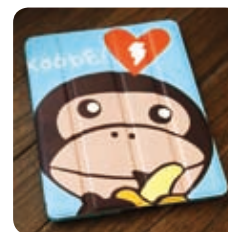

## CS-CO Series Round Badge

- Round badge
- One set includes the upper shell, mylar and backside with pin
- Qty / CTN: 1000pcs



### ▼ Specifications

Model	CS-CO-25	CS-CO-32	CS-CO-37	CS-CO-44	CS-CO-50	CS-CO-56	CS-CO-58	CS-CO-75
Size	25mm (0.98")	32mm (1.25")	37mm (1.45")	44mm (1.73")	50mm (1.96")	56mm (2.20")	58mm (2.28")	75mm (2.95")
Price	≤ \$53 / CTN	≤ \$62 / CTN	≤ \$62 / CTN	≤ \$69 / CTN	≤ \$76 / CTN	≤ \$76 / CTN	≤ \$76 / CTN	≤ \$117 / CTN

## CS-CO-T Series Oval Badge

- Oval badge
- One set includes the upper shell, mylar and backside with pin
- Qty / CTN: 1000pcs



### ▼ Specifications

Model	CS-CO-25T	CS-CO-35T	CS-CO-45T	CS-CO-55T	CS-CO-70T
Size	25mm x 18mm (0.98" x 0.70")	39mm x 31mm (1.53" x 1.22")	47mm x 32mm (1.85" x 1.26")	57mm x 45mm (2.24" x 1.77")	69mm x 45mm (2.72" x 1.77")
Price	≤ \$50 / CTN	≤ \$104 / CTN	≤ \$104 / CTN	≤ \$127 / CTN	≤ \$134 / CTN



## CS-JZ Series Mirror Button with Plastic Ring

- Used for promotion activities
- One set includes the upper shell, mylar and mirror with key-chain
- Qty / CTN: 1000pcs

### ▼ Specifications

Model	CS-JZ-58	CS-JZ-75
Size	58mm (2.28")	75mm (2.95")
Price	≤ \$124 / CTN	≤ \$179 / CTN

## CS-XH Series Rosette Button

- Rosette with paper back with size diameter 70mm (2.76") / 80mm (3.15") / 90mm (3.5")
- Compatible with pin badge 50mm (1.97") / 56mm (2.2") / 58mm (2.28")
- Available Colors: red, blue, yellow, green, white, etc
- Customized colors are acceptable
- Qty / CTN: 1000pcs



### ▼ Specifications

Model	CS-XH-44	CS-XH-58	CS-XH-75
Size	44mm (1.73")	58mm (2.28")	75mm (2.95")
Price	≤ \$189 / CTN	≤ \$210 / CTN	≤ \$344 / CTN

## CS-XJ Series Photo Stand Button

- Used for promotion activities
- One set includes the upper shell, mylar, back plastic stand part
- Qty / CTN: 1000pcs



### ▼ Specifications

Model	CS-XJ-58	CS-XJ-75	CS-XJ-100
Size	58mm (2.28")	75mm (2.95")	100mm (3.93")
Price	≤ \$124 / CTN	≤ \$156 / CTN	≤ \$212 / CTN





## CS-ZB-100: 100MM Clock Button

- The size is 100mm (3.93") in diameter
- Used for promotion activities
- One set includes the upper shell, mylar, plastic back part, metal stand, mechanism and hands
- Qty / CTN: 100pcs
- Price: ≤ \$112 / CTN



## Sublimation Inks

### ▼ Specifications

Picture	Model	Name	Suitable Printer	Color	Volume	Price
	<b>SUBL-INK-KOR-002</b>	1000ML Sublimation Ink (Korea)	Mutoh, Epson, Mimaki, Roland, etc.	C, M, Y, K, LC, LM	1000ml / Bottle	≤ \$57 / L
Fast and excellent color stability; It is mainly suitable for materials of fabrics (PE, Nylon and fiber, etc.), acrylic, metal, wood and stone. Place of origin is Korea.						
	<b>SUBL-INK-KOR-003</b>	600ML Sublimation Ink (Korea)	Epson series	C, M, Y, K, LC, LM	600ml / set	≤ \$34.99 / set
Fast and excellent color stability, It is mainly suitable for materials of fabrics (PE, Nylon and fiber, etc.), acrylic, metal, wood and stone. One set include 6 bottles ink, 100ml / bottle. Place of origin is Korea.						
	<b>SUBL-INK-ITA-002</b>	1000ML Original Sublimation Ink (Italy Jteck)	Mutoh, Epson, Mimaki, Roland, etc.	C, M, Y, K	1000ml / Bottle	≤ \$106.06 / L
Fast and excellent color stability; Delivers complete chromatograph & bright colors. It is mainly suitable for materials of fabrics (PE, Nylon and fiber, etc.), acrylic, metal, wood and stone, etc. Place of origin is Italy.						
	<b>SUBL-INK-TW-CHMYM</b>	1000ML Fluorescent Sublimation Ink (TW)	Mutoh, Epson, Mimaki, Roland, etc.	M, Y	1000ml / Bottle	≤ \$127.64 / L
Fast and excellent color stability; Bright color and fluorescent in dark. It is mainly suitable for materials of fabrics (PE, Nylon and fiber, etc.). Place of origin is Taiwan.						

### ▼ Samples





# 02 ENGRAVING PRODUCTS

All the Equipments Have a **2 Year** Warranty



Price: ≤ \$4,370 / set  
on P228



Price: ≤ \$6,033 / set  
on P213



Price: ≤ \$265 / set  
on P244



Price: ≤ \$480 / pc  
on P254



Price: ≤ \$230 / set  
on P249

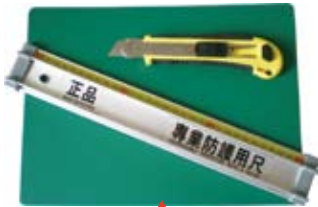

Price: ≤ \$19.17 / pc  
on P271



Price: ≤ \$42 / pc  
on P257



Price: ≤ \$12 / pack  
on P255



Price: ≤ \$6.45 / pc  
on P269

## P200 | Engraving & Cutting Machine

P200 | Laser engraver

P213 | Laser cutter

P222 | Laser marker

P224 | CNC engraver & router

P239 | CNC cutter

## P244 | Vinyl Cutter

## P249 | Engraving Auxiliary Products

## P257 | Channel Letter Making Machine and Material

## P261 | Acrylic Finishing Machine

## P265 | Engraving Supplies

P265 | Engraving bits

P267 | Cutting self - adhesive vinyl & squeegees

P268 | Glue & advertising nail

P269 | Cutting mat & craft knives

P271 | Advertising protectional ruler

P272 | Engraving Board & Sheet

## LEM-K25: Horizontal Desktop Laser Engraver

- New mechanical construction, larger working area
- Longer service life
- Automatic lifting table, fine quality



### ▼ Specifications

Model	LEM-K25
Maximum Engraving Area	240mm x 250mm (9" x 10")
Maximum Stamp engraving Area	120mm x 60mm (5" x 2.4")
Laser Power	CO2 glass tube 25W
Engraving Speed	150mm (6") / s
Minimum Engraving Letters	English letters: 1mm (0.039")
Resolution	<=1000dpi
Power Support	AC110V - 220V, 50 / 60Hz
Machine Dimension	800mm x 450mm x 285mm (31" x 18" x 11")
Machine Weight	45kg
Software	YZWIN Stamp Editing Software
<b>Price</b>	<b>≤ \$1,278</b>

### ▼ Samples - Stamp engraving

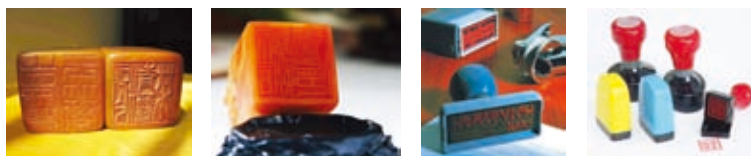

## LEM-LW-5030: Desktop Laser Engraving Machine

**Electric lift worktable + red laser pointer + gradient engraving + support CorelDraw output directly.**

It can engrave on nonmetal materials, such as bamboo, putamina of coconut, paper, plexiglass, acrylic, marble, jade, crystal, and so on. It also can do simple cutting process. It is our entry - level model combines affordability with a convenient small size and it is specifically for the finest details and high - quality laser engraving.

- Compact structure, reasonable layout, stable performance and could continuously work for a long time.
- Perfect engraving effect, smooth incision and narrow joint - cutting.
- Electronic control lift platform, easy and flexible to operate, can engrave materials with different height.
- Red laser pointer can realize accurate positioning.
- It supports various file formats PLT, BMP (1bit), DXF, AI, etc which created by the drawing software and can carve various graphs and words.

### ▼ Specifications

Model	LEM-LW5030
Maximum Engraving Area	430mm x 300mm (17" x 12")
Maximum Cutting Area	447mm x 300mm (18" x 12")
Laser Power	CO2 glass tube 40W
Maximum Engraving Speed	1200mm (48") / s
Resolution	<=1000dpi
Minimum Engraving Letters Size	English letters 1mm (0.04")
Gradient Carving	Yes
Lift Worktable	Electric adjust
Power Support	AC110V - 220V, 50 / 60Hz
Machine Dimension	800mm x 450mm x 285mm (31" x 18" x 11")
Machine Weight	64kg
Software	LaserCut 5.3 software
Optional Device	Rotary fixture, water chiller, clamping apparatus (for stamp engraving)
Spare Parts	Reflective mirror, lens, and laser tube
<b>Price</b>	<b>≤ \$3,800</b>



Rotary fixture

With rotary fixture, it can engrave on a cylinder object, such as cup, pencil vase. It breaks through the limitation of the planar engraving and augments the range of the working.

### ▼ Samples



Acrylic engraving

Corrugated paper cutting

Engraving on coconut shell

## LEM-T40: Desktop Laser Engraver

- Red light indicator
- Automatic focus and up - down table (Special for round stamp)
- Support gradient carving

### ▼ Specifications

Model	LEM-T40
Maximum Engraving Area	400mm x 240mm (16" x 9")
Laser Power	CO2 glass tube 25W
Engraving Speed	150mm (6") / s
Minimum Engraving Letters	English letters: 1mm
Resolution	<=1000dpi
Power Support	AC110V - 220V, 50 / 60Hz
Machine Dimension	800mm x 800mm x 430mm (32" x 32" x 17")
Machine Weight	50kg
Software	ZWIN Stamp Editing Software (CSACE and Printing Driver software)
<b>Price</b>	<b>≤ \$3,966</b>



### ▼ Samples



Bracelet engraving



Paper cutting



Rubber engraving

## LEM-ZTGD-4028: High Precision Handicraft Laser Engraver



- It is especially designed to meet the requirements of crafts, advertisement and decoration industries.
- It can engrave on most nonmetal materials, such as wood block, bamboo block, cardboard, rubber, goods, organic glass, glass and crystal, leather clothing etc.
- With smart design, high engraving precision, the laser engraving and cutting machine is convenient to use.
- High engraving precision and various functions.
- Integrating optics, machinery and electricity.
- LPT interface, you can operate the laser engraver with PC directly.
- Equipped with **manual up - down lift worktable**, it is easy to focus, freely up and down 0 - 150mm (0" - 6") of height. It can engrave on different thickness of materials.

### ▼ Specifications

Model	LEM-ZTGD-4028
Maximum Engraving Area	400mm x 280mm (16" x 11")
Maximum Stamp Engraving Area	100mm x 120mm (4" x 5")
Laser Power	CO2 glass tube 40W
Engraving Speed	200mm (8") / s
Minimum Engraving Letters	English letters: 0.5mm (0.02")
Resolution	<=1000dpi
Power Support	AC110V - 220V, 50 / 60Hz
Machine Dimension	800mm x 530mm x 960mm (32" x 21" x 38")
Machine Weight	90kg
Software	Laser marking system V2010 software
<b>Price</b>	<b>≤ \$2,203</b>



Rotary fixture

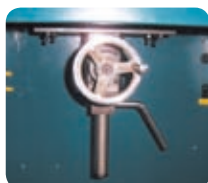

Manual lift worktable

### ▼ Samples



Stamp engraving



Engraving on coconut shell



Engraving on silicone resin



Sign making



Acrylic engraving

## LEM-R Series Hyperfine Laser Engraver with one set of accessories

### Special for Craft and Gift Industry - Hyperfine engraving effect

#### Accessories Gift Set: Laser tube (1 pc), focus lens (1 pc), reflective mirror (1 pc).

Ideal solution for trophy and award businesses! It is suitable for music instrument, art gift, advertising decoration, toy, electronic industry, cutting of template, paper product and other industries.

They can engrave on nonmetal materials, such as bamboo, putamina of coconut, paper, plexiglass, acrylic, marble, jade and crystal. With the rotating unit, it can engrave on cylinder objects, such as cup, pencil vase and so on.

- Automatic lift table, enough height in Z direction, can work on objects up to 250mm (10").
- Adopts the leading "Smart Engraving" technology, so it can engrave English letters of 1mm (0.04").
- Up to 31IPS (80cm / s) high working speed with glass tube. Working speed of RF tube machine can reach up to 59 IPS (150cm / s). These speeds are the highest in China.
- Along with the laser engraving machine, there are **two sets of software, CSACE and Print Driver**. CSACE can input BMP, PLT file format design, then edit and output them; Print Driver can directly output many file formats in Windows, like Photoshop, CorelDraw and AutoCAD etc.

With rotary fixture, it can engrave on a cylinder object, such as cup, pencil vase and so on. It breaks through the limitation of the planar engraving and augments the range of the working.

Bigger rotary fixture	Used for $\Phi 8 \sim 100\text{mm}$ column
Smaller rotary fixture	Used for $\Phi 5 \sim 20\text{mm}$ column
Three claw rotary fixture	Used for $\Phi 160 \sim 260\text{mm}$ column, automatic alignment center



Bigger rotary fixture



Smaller rotary fixture



Three claw rotary fixture

#### ▼ Samples



LEM-R80



LEM-R60



High-quality

#### ▼ Specifications

Model	LEM-R60	LEM-R80	LEM-R100
Maximum Engraving Area	610mm x 450mm (24" x 18")	800mm x 500mm (31" x 20")	990mm x 450mm (39" x 18")
Laser Power	CO2 glass tube 40W	CO2 glass tube 60W	CO2 glass tube 60W
Maximum Engraving Speed	800mm (31") / s	800mm (31") / s	800mm (31") / s
Resolution	$\leq 1000\text{dpi}$	$\leq 1000\text{dpi}$	$\leq 1000\text{dpi}$
Minimum Engraving Letters Size	English letters 1mm (0.04")	English letters 1mm (0.04")	English letters 1mm (0.04")
Gradient Carving	Yes	Yes	Yes
Lift Worktable	Electric adjust	Electric adjust	Electric adjust
Power Support	AC110V - 220V, 50 / 60Hz	AC110V - 220V, 50 / 60Hz	AC110V - 220V, 50 / 60Hz
Machine Dimension	1000mm x 920mm x 1040mm (39" x 36" x 41")	1250mm x 1120mm x 1060mm (49" x 44" x 42")	1400mm x 920mm x 1040mm (55" x 36" x 41")
Machine Weight	120kg	150kg	170kg
Software	CSACE engraving software and Printing Driver software		
Optional Device	Rotary fixture, RF Laser tube imported from USA		
Spare Parts	Reflective mirror, lens, and laser tube		
<b>Price</b>	<b><math>\leq \\$8,080</math></b>	<b><math>\leq \\$7,813</math></b>	<b><math>\leq \\$9,182</math></b>



## LEM-LD Series Laser Engraving & Cutting Machine

High speed and fine engraving effect + Electrical lift worktable + Support CorelDraw output directly

- They can engrave on most kinds of nonmetal materials and parts of coated metals, it also features a cutting function.
- Luxurious outlook design, unique door for the limitless engraved materials through.
- Professional DSP controlling system, compatible with AutoCAD, CorelDraw, Photoshop, and other kinds of graph disposal software.
- Equipped with electrical up - down lift working platform, its maximum Lifting height can reach to 300mm (12"), which greatly broaden the scope of processing objects.
- Importing high precision beeline slide - ways, importing professional optical system, improve the engraving quality.



Pass - through front and rear doors

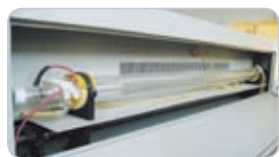

CO2 glass laser tube



Economical



Rotary fixture



### ▼ Specifications

Model	LEM-LD-600H	LEM-LD-900H	LEM-LD-1200H	LEM-LD-1600H
Maximum Engraving Area	600mm x 400mm (24" x 16")	900mm x 600mm (35" x 24")	1200mm x 900mm (47" x 35")	1600mm x 1150mm (63" x 45")
Laser Power	CO2 glass tube 40W	CO2 glass tube 60W	CO2 glass tube 80W	CO2 glass tube 80W
Maximum Engraving Speed	1300mm (51") / s	1300mm (51") / s	1300mm (51") / s	1300mm (51") / s
Maximum Cutting Speed	160mm (6") / s	160mm (6") / s	160mm (6") / s	160mm (6") / s
Resolution	<=1000dpi	<=1000dpi	<=1000dpi	<=1000dpi
Minimum Engraving Letters Size	English letters: 1.5mm (0.06")	English letters: 1mm (0.04")	English letters: 1.5mm (0.06")	English letters: 1.5mm (0.06")
Gradient Carving	Yes	Yes	Yes	Yes
Lift Worktable	Electrical adjust	Electrical adjust	Electrical adjust	Electrical adjust
Power Support	AC110V - 220V, 50 / 60Hz			
Machine Dimension	1006mm x 915mm x 734mm (40" x 36" x 29")	1340mm x 885mm x 960mm (53" x 35" x 38")	1650mm x 1180mm x 960mm (65" x 47" x 38")	2053mm x 1240mm x 900mm (81" x 49" x 36")
Machine Weight	90kg	160kg	200kg	230kg
Software	Lasercut 5.3 engraving software			
Optional Device	Rotary fixture, water chiller			
Spare Parts	Reflective mirror, lens, and laser tube			
<b>Price</b>	≤ \$4,429	≤ \$4,661	≤ \$5,101	≤ \$5,994

### ▼ Samples

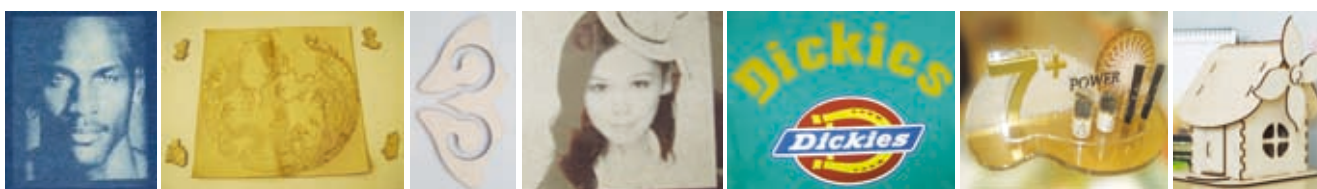

## LEM-CM120: Laser Cutting & Engraving Machine

Electric lift worktable + Support CorelDraw output directly. Has engraving and cutting function

**Typical application:** Acrylic decoration cutting, thick acrylic cutting, wood board cutting, model cutting, and column engraving. Be suitable for advertisement decoration, art gift, cutting of model, toy, paper products and other industries.

- Be updated from LCM-B series, it includes all functions of LCM-B series, but increases a large - scale of automatic up-down lifting worktable, so its maximum height of processing can reach 210mm (8").
- More beautiful appearance, higher quality than LCM-B series laser cutting machine.
- Adopt the super fine cutting technology. The accuracy is greater, the tremble is slighter, cutting carve is smoother.
- USB data interface, you can use MSF to save multiple files at the same time.
- Two sets of software with the machine: CSACE and Print Driver. CSACE can input BMP, PLT file format design, then edit and output them, Print Driver can directly output many file format in Windows system, like Photoshop, CorelDraw, AutoCAD, etc.
- It adopts high quality CO2 80W glass laser tube made in China with fine cutting effect and advantage of price.
- Equipped with high quality water chiller, which can extend the using life of laser tube and ensure better engraving effect.



Three claw rotary fixture



Bigger rotary fixture

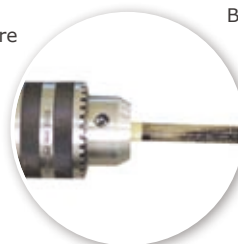

Smaller rotary fixture

With rotary fixture, it can engrave on a cylinder object, such as cup, pencil vase and so on. It breaks through the limitation of the planar engraving and augments the range of the working.

Bigger rotary fixture	Used for $\Phi 8 \sim 100\text{mm}$ column
Smaller rotary fixture	Used for $\Phi 5 \sim 20\text{mm}$ column
Three claw rotary fixture	Used for $\Phi 160 \sim 260\text{mm}$ column, automatic alignment center

### ▼ Specifications



Model	LEM-CM120
Maximum Cutting Area	1300mm x 620mm (51" x 24")
Laser Power	CO2 glass tube 80W
Maximum Engraving Speed	800mm (31") / s
Maximum Cutting Speed	640mm (25") / s
Resolution	$\leq 8000\text{dpi}$
Maximum Cutting Thickness	20mm (0.8" acrylic), 10mm (0.4" wood)
Motor	Step motor
Lift Worktable	Electric adjust
Power Support	AC110V - 220V, 50 / 60Hz
Machine Dimension	1900mm x 1200mm x 1030mm (75" x 47" x 41")
Machine Weight	170kg
Software	CSACE engraving software and Printing Driver software
Optional Device	Rotary fixture, laser tube
Spare Parts	Reflective mirror, lens, and laser tube
<b>Price</b>	<b><math>\leq \\$7,438</math></b>

### ▼ Samples



## LEM-Z-DQ Series Economic Laser Engraving & Cutting Machine

Electric up - down lift worktable & Support CorelDraw output directly.

High speed, high engraving precision and multi - function

They can engrave on most nonmetal materials, such as wood block, bamboo block, cardboard, marble, rubber, goods, organic glass, glass, crystal and leather clothing, etc.

- They integrate optics, machinery and electricity, and adopt special laser software, which can design image freely by computer.
- Adopting special structure and controlling system, kerf is small, cutting edge is smooth, which effectively meet high precision cutting requirement.
- Import optical mirrors, high - temperature endurable, anti - abrasive, small diameter of focalizing facula, ensure higher cutting ability compared with the machine of the same laser power.
- Touching LED control panel, LCD display, completely off - line work, effectively save computer source.
- With rotary fixture, it can engrave on a cylinder object.



LEM-Z-DQ-9060E

### ▼ Specifications

Model	LEM-Z-DQ-6040E	LEM-Z-DQ-9060E	LEM-Z-DQ-12590E
Maximum Engraving Area	600mm x 400mm (24" x 16")	900mm x 600mm (35" x 23")	1250mm x 900mm (49" x 35")
Laser Power	CO2 glass tube 50W	CO2 glass tube 60W	CO2 glass tube 80W
Maximum Engraving Speed	1000mm (39") / s	1000mm (39") / s	1000mm (39") / s
Maximum Cutting Speed	120mm (4.7") / s	120mm (4.7") / s	300mm (12") / s
Resolution	<=1000dpi	<=1000dpi	<=1000dpi
Minimum Engraving Letters Size	English letters 0.5mm (0.02")	English letters 0.5mm (0.02")	English letters 1mm (0.04")
Gradient Carving	Yes	Yes	Yes
Lift Worktable	Electric adjust	Electric adjust	Electric adjust
Power Support	AC110V-220V, 50 / 60Hz	AC110V-220V, 50 / 60Hz	AC110V-220V, 50 / 60Hz
Machine Dimension	1200mm x 750mm x 1100mm (47" x 30" x 43")	1500mm x 950mm x 1100mm (59" x 37" x 43")	1900mm x 1440mm x 1160mm (75" x 57" x 46")
Machine Weight	100kg	160kg	300kg
Software	Lasercut 5.3 engraving software		
Optional Device	Rotary fixture, red laser pointer		
Spare Parts	Reflective mirror, lens, and laser tube		
<b>Price</b>	≤ \$5,000	≤ \$5,068	≤ \$6,280

## LEM-GL-JG10060: Multi - function Movable Laser Engraver

The laser engraver is mainly suitable for marble, granite, tile engraving. And it is also used to engrave other nonmetal materials, such as acrylic, cloth, leather, wood, and so on.

- Opening and movable working table design, convenient to process.
- Engraving area is unlimited; it can slice engraving shapes precisely and make large area shapes, no need to consider the weight of workpiece as processing large scale image.
- Up - down work tables, suitable for engraving different thickness items.
- The laser engraving machine can engrave most kinds of nonmetal materials, such as glass, marble, tomb stone, ornaments and decoration, furniture, timber process, door manufacturing, etc. It also can cut part of nonmetal materials.
- Rotary fixture can be equipped to engrave cylinder vase, pencil vase, pencil and bamboo craftwork.

### ▼ Specifications

Model	LEM-GL-JG10060
Maximum Cutting Area	1000mm x 600mm (39" x 24")
Laser Power	CO2 glass tube 60W
Maximum Engraving Speed	600mm (24") / s
Maximum Cutting Speed	600mm (24") / s
Resolution	<=1000dpi
Maximum Cutting Thickness	10mm (0.4") acrylic
Motor	Step motor
Lift Worktable	Electric adjust
Power Support	AC110V - 220V, 50 / 60Hz
Machine Dimension	1620mm x 1250mm x 1270mm (64" x 49" x 50")
Machine Weight	245kg
Software	Lasercut 5.3 engraving software
Optional Device	Rotary fixture
Spare Parts	Reflective mirror, lens, and laser tube
<b>Price</b>	≤ \$7,933



## LEM-FB-1813A: Flatbed Laser Cutting & Engraving Machine

### Shoe leather and cloth mass manufacturing solution

It is equipped with honeycomb working table, fit for advertising decoration, art gift, toy, garment, fabric, leather and other industries.

- Automatic feeding is convenient for moving material. (Optional)
- The laser engraver has the function of cutting, engraving and scanning on large scale.
- On every processing spot of the worktable, fixed laser outputs ensures stable quality and uniform cutting on large format.
- It adopts the super fine cutting technology, which assures greater accuracy, slighter tremble and smoother cutting curve.
- It adopts high quality CO2 80W glass laser tube made in China with fine cutting effect and advantage of price.
- High quality CW-5000 water chiller, it can extend the using life of laser tube and ensure the engraving effect better.
- Two sets of software with the machine, CSACE and Print Driver. CSACE can input BMP, PLT file format design, then edit and output them; Print Driver can directly output many file format in Windows system, like Photoshop, CorelDraw, AutoCAD, etc.
- Pen type laser head, it is easy to adjust the focus, cooling effect by blowing is good.
- LCD display control panel, easy and safe operation.



LEM-FB-1813A

### ▼ Samples

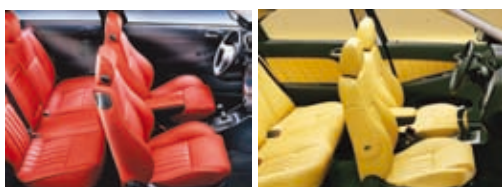

Conveyor belt



Automatically roller

### ▼ Specifications

Model	LEM-FB-1813A / LEM-FB-1813S
Maximum Cutting Area	1800mm x 1300mm (71" x 51")
Laser Power	CO2 glass tube 80W (Normal using life: About 1000-2000 hours)
Maximum Engraving Speed	1000cm (39") / min (Adjustable)
Maximum Cutting Speed	600mm (24") / s
Resolution	<=1000dpi
Maximum Cutting Thickness	20mm (0.8") acrylic
Motor	Stepper motor / Servo motor
Lift Worktable	No
Power Support	AC110V - 220V, 50 / 60Hz
Machine Dimension	2350mm x 1950mm x 1100mm (92" x 77" x 43")
Machine Weight	350kg
Software	CSACE engraving software and Printing Driver software
Optional Device	R.F. tube 50 / 100W (recyclable), CO2 glass tube 120W
Spare Parts	Reflective mirror, lens, and laser tube
<b>Price</b>	<b>≤ \$10,578</b>





## LCM-GFB-1830: Large Format Glass Laser Engraving Machine

It is used to architecture decoration, art, furniture and other industries. It is suitable for cutting sandblast covering materials of large format glass surface.

- Large working area with a high load bearing working table, roller working platform makes the work pieces move freely on the cutting table, saving labor and energy.
- Equipped with high quality CW-5000 water chiller, it can extend the using life of laser tube and ensures a better engraving effect.
- The machine comes with two sets of software, CSACE and Printing Driver. CSACE can input BMP and PLT file format design, then edit and output them; Print Driver can directly output many file format in Windows system, like Photoshop, CorelDraw, AutoCAD, etc.
- Power source is the core technology, this laser engraver adopts original alterable internal resistance mode instead of traditional PWM pulse width modulation mode. The new power source mode has more powerful internal resistance, higher stability and higher reliability, which can raise good ballast effect.



Controller



Roller working platform



CO2 laser tube



80W power source



Pen type laser head



CW 5000 water chiller

### ▼ Specifications

Model	LCM-GFB-1830
Maximum Cutting Area	1800mm x 3000mm (71" x 118")
Laser Power	CO2 glass tube 80W (Normal using life: about 1000 - 2000 hours)
Maximum Engraving Speed	10000mm (39") / min (Adjustable)
Maximum Cutting Speed	600mm (24") / s
Resolution	≤4000dpi (4000dpi is the best)
Maximum Cutting Thickness	20mm (0.8") acrylic
Motor	Stepper motor
Lift Worktable	No
Power Support	AC110V - 220V, 50 / 60Hz
Machine Dimension	2050mm x 3700mm x 1350mm (81" x 146" x 53")
Machine Weight	680kg
Software	CSACE engraving software and Printing Driver software
Optional Device	R.F. tube 50 / 100W (recyclable), CO <sub>2</sub> glass tube 120W
Spare Parts	Reflective mirror, lens, and laser tube
<b>Price</b>	<b>≤ \$19,393</b>



### ▼ Samples



## > Engraving & Cutting Machine > Laser engraver

Using laser technology, we can create any image into crystal. The image is processed through the computer and output to a laser machine which engraves the image into a chosen crystal from our selection.

The laser is focused into the glass; in the focal point the energy is so high that the structure is change in a small point. The laser beam is computer controlled; an image made of thousand small points is the outcome. The image stays the same in its brilliance and appearance. It will not turn yellow or change its look. The picture stays in the glass for eternity. Except, if you should heat it over 500 degree.

### ▼ Generally, we can divide crystal industry into:

(1) 3D portrait



(2) 2D graphics & photos



(3) Customized engraving



### ▼ How does laser process work

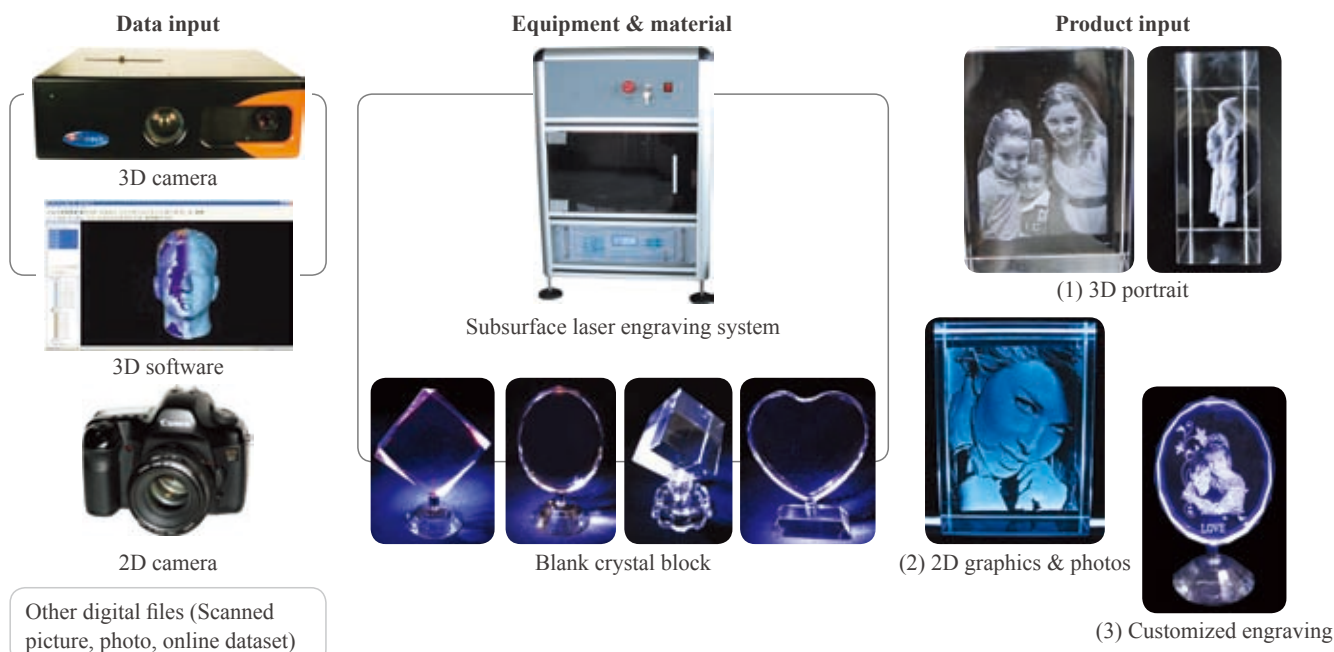

### ▼ How does laser process work?

#### Step1: 3D Capturing

10 seconds

Take a portrait using our 3D camera. You can also create a special 3D design for your customer using CAD software.

#### Step2: 3D Image Processing

2 – 6 minutes

Process the data using our design software. It is easy for you to create complex laser images, because a template and guide for your glass image is included in software.

#### Step3: Laser Engraving

1 – 2 minutes

Transfer your image template to one of our laser systems. The laser beam will then burn it into crystal glass with maximum precision and at high speed. The surface remains smooth and flawless.

#### Step4: Portrait Crystal

1 – 2 minutes

(The whole process takes 5-10 minutes)

Now captured forever, you can present a wonderful 3D crystal portrait to your customer in just a few minutes!

## LSEM-LD-EG-502-16: YAG 16 heads Laser Sub - surface Engraving Machine

It is mainly suitable for **personalize photo crystal craft and crystal souvenirs mass production.**

You can use our laser subsurface engraving machine to engrave 3D images in crystal and glass products, etc., at same time, it can produce the individual crystal gifts and souvenirs, such as 3D images, personal name, handprint, footprint and trophy etc., it also can work for a large scale production of 2D, 3D animals & plants, architectures, models such as car, boat, airplane etc, and 3D scene show.



Economical

### ▼ Main Configuration Information:

Maximum Engraving Range: 300mm x 300mm x 85mm  
(11.8" x 11.8" x 3.35") DSP, YAG (Xe - lamp), 16 laser heads

<b>Standard Equipment</b>	Main machine
	PC (Including dot cloud conversion software and engraving controlling software)
	User manual
	Protect glass
	Other accessories
	Graphic disc (1000 3D pictures)
	<b>3D camera (Optional)</b>

- Laser subsurface engraving machine is laser processing equipment integrating optics, machinery, and electron. It adopts the laser technology, computer control technology, and high precision, high efficient servo control system.
- The machine can engrave all kinds of exquisite perfect three - dimensional pattern inside the transparent crystal glass in different specs and shapes.
- LSEM-LD-EG-502-16 laser sub - surface engraving machine is a laser machine with 16 heads, it could engrave the image in blank crystal. The products will give person pure - clear crystal and fine noble visual image impression, which is ingenious for your home decoration.

### ▼ Specifications

Model	LSEM-LD-EG-502-16	
Laser Medium	Nd: YAG lamp	
Laser Wavelength	532nm	
Laser Frequency	100Hz	
Maximum Engraving Range	300mm x 300mm x 85mm (11.8" x 11.8" x 3.35")	
Maximum Engraving Speed	4000 - 6000dots / min	
Number of Laser Heads	16	
Maximum Power of the whole machine	2 x 3KW	
Control System	Servo control system	
Spare Parts	Xe - lamp (400 hours continuous working)	
Continuous Working Time	12hrs	
Electrical Connection	AC220v ± 10%, 50 - 60hz	
Dimension of the Whole Machine	700mm x 760mm x 1530mm (27.6" x 30" x 60")	
Weight of the Whole Machine	303kg	
Room temperature	15 - 35°C	
Engraving time	50mm x 50mm x 80mm	6 - 8mins
	30mm x 20mm x 20mm	1.5mins
<b>Price</b>	<b>≤ \$31,113</b>	

### ▼ Samples



## LSEM-WLD-photo3D-602A: Rapid Scanner Laser Subsurface Engraving Machine

**It is mainly suitable for personalize photo crystal craft.**

It can produce the individual crystal gifts and souvenirs, such as 3D images, personal name, handprint, footprint and trophy etc., it also can work for a large scale production of 2D, 3D animals & plants, architectures, models such as car, boat, airplane etc, and 3D scene show.

- Under the perfect combination of our integrated system - 3D Vision Software of the 3D Camera and Laser Control Software to cooperate with our laser machine, you can get Super High Resolution Crystal Engraving.
- This laser subsurface engraving machine adopted the advanced galvanometer scanner technology together with 2KHz diode - pumped YAG frequency doubling laser which is faster, the laser point is more thin and bright, the image also will be more elaborate and lively.
- The key parts of the apparatus mainly come from Germany and the USA. It is more reasonable and steady for long - term production.
- Suitable for individual production and batch fast process. Just one machine could be satisfied with capacity for both storefronts network distribution and electric - business distribution.
- The smaller size and lighter weight can be carried and fixed easily, and the protective package can keep the machine well.

### ▼ Main Configuration Information:

Maximum Engraving Range: 100mm x 100mm x 80mm (3.9" x 3.9" x 3.15")

Galvanometer Scanner, Technology, DSP, 3 Dimension, 2000Hz diode-pumped YAG.

<b>Standard equipment</b>	Main machine
	PC (Including dot cloud conversion software and engraving controlling software)
	User manual
	Protect glass
	Other accessories
	Graphic disc (1000 3D pictures)
	<b>Advanced conversion system (Optional)</b>

### ▼ Optional Device:

3D Camera: **+\$14,000** (made in China), **+\$19,800** (Import from Italy)

### ▼ Samples



### ▼ Specifications

Model	LSEM-WLD-photo3D-602A
Laser Medium	Nd: diode-pumped (can work more than 10000 hours)
Laser Wavelength	532nm
Laser Frequency	2000Hz
Maximum Engraving Range	100mm x 100mm x 80mm (3.9" x 3.9" x 3.15")
Maximum Engraving Speed	8000 - 10000dots / min
Number of Laser Heads	1
Maximum Power of the whole machine	1 KW
Control System	Servo control system, Galvanometer Scanner, Technology, DSP, 3D
Cooling System	Semiconductor Cooling
Spare Parts	No
Continuous Working Time	12hrs
Electrical Connection	AC220v ± 10%, 50 - 60hz
Dimension of the Whole Machine	580mm x 550mm x 700mm (22.8" x 21.6" x 27.6")
Weight of the Whole Machine	65kg
Room temperature	15 - 35°C
Engraving time	50mm x 50mm x 80mm about 2 mins 30mm x 20mm x 20mm about 0.7 mins

**Price**

≤ \$39,256



## LMM-LD-FEM-G3005: Flying Green Laser Subsurface Engraving & Surface Mark

Mainly used for Glass packaging products, such as wines, food, drinks, medicine, etc. Anti - counterfeiting code, Anti - Channel Conflict code, region code, and winning number inner engraving.

It is more suitable for the subsurface or surface of glass engraving (Such as hard drink glass bottle, mobile key press, cell phone screen, LCD screen, optical components, optical lenses, car glass, etc). It is also applied to the most of metal and nonmetal materials, processing surface lining or engraving on glass, crystal, and coating film marking process, such as deep processing of Solar photovoltaic cells glass, etc.

### ▼ Main Configuration Information

Combined with our product information track management software, it is the best weapon against counterfeits and cross region sale!

no need to change the semiconductor module during 3 - 5 years, 2000 - 4000 bottles per hour processing capacity.

**Adopt imported components of Euro & USA**

**Maximum Marking Range:** 100mm x 100mm (3.9" x 3.9") (static state)

**Minimum letters:** 2mm (0.079")

**Repeat Accuracy:** ±0.001mm

50 kHz repeat frequency

<b>Standard equipment</b>	Main machine
	PC (Including dot cloud conversion software and engraving controlling software)
	User manual
	Protect glass
	Other accessories
	Graphic disc (1000 3D pictures)



- Subsurface Engraving the security code or regional code in the body or bottom side of the bottle. Can not removed by medicinal liquid or grinding wheel, only damaged glass bottle you can get rid of the mark! Truly deep permanent security!
- On - line full - auto laser marking, it only requires one time investment with low maintenance cost and long - term benefit, **no need to change the semiconductor module during 3 - 5 years, 2000 - 4000 bottles per hour processing capacity.**
- Letters, numbers, drawings such as anti - counterfeiting code, Anti - Channel Conflict code, logistics information code, production date etc. Could be laser subsurface engraved into transparent bottle wall in the automatic packaging line through opto - mechatronics laser controlling technology to obtain smooth wine surface without damage. **Combined with our product information track management software, it is the best weapon against counterfeits and cross region sale!**
- The wavelength of LMM-LD-MK-G3005 Green Laser Subsurface Engraving & Flying Surface Marking Machine is 532nm green laser. After focus, it has the smaller focus, become more powerful, higher conversion of the electron & laser.

### ▼ Bottle fighting yards



**Laser inside carving  
Anti - counterfeit marking yards**

### ▼ Specifications

Model	LMM-LD-FEM-G3005
Laser Medium	Semiconductor module (Can work more than 20000 hours)
Maximum Laser Average Power	5W
Laser Wavelength	532nm
Quality of the Laser M2	< 1.5
Repeat Frequency	≤50kHz
Standard Engraving Scope	100mm x 100mm (3.9" x 3.9") (Static state)
Marking Depth	≤0.1mm
Linear Speed	8 meters / min (Simplex, 3 characters 3mm high)
Minimum Character	2mm
Repeat Accuracy	±0.001mm
Input Power	1KW
Number of Laser Heads	1
Control System	Servo control system, Galvanometer Scanner, Technology, DSP, 3D
Cooling System	Semiconductor Cooling
Spare Parts	No
Continuous Working Time	12hrs
Electrical source	220V / single - phase, 50Hz, 10A
Dimension of main machine	1135mm x 635mm x 1310mm (45" x 25" x 52")
Dimension of cooling system	670mm x 300mm x 475mm (26" x 12" x 19")
<b>Price</b>	<b>≤ \$46,074</b>



## LSEM-WLD-602C: Large Format Sub - surface Laser Engraving Machine

It is **mainly suitable for glass architectural ornament engraving**. Also it can be used to engrave 2D, 3D images or individual figures in crystal, and other transparent material products.

It is suitable for advertising lightbox, signboard, undertaking culture revelation, glass decorating, upholstering, glass furniture decoration, glass individuation decoration, large scale wedding photo, large scale religion arts and crafts, and other relative industries. Assorting the LED lamp, it may appear the supernatural, elegance and fresh impression.

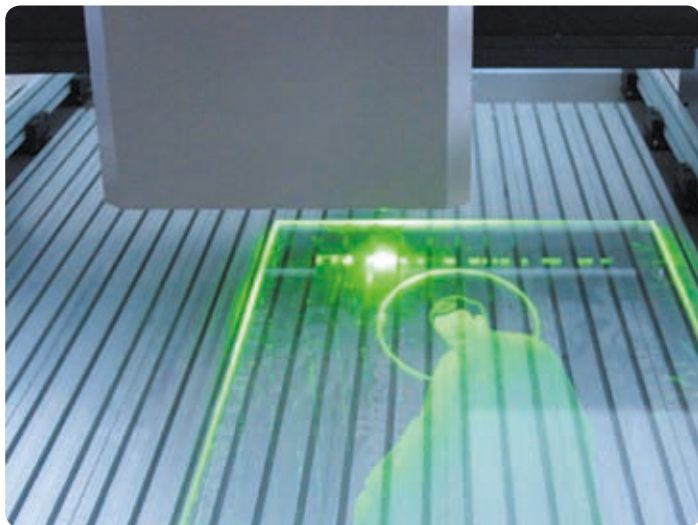

### ▼ Main Configuration Information

**Maximum Engraving Range:** 1500mm x 1000mm x 80mm  
(59" x 39" x 3.15")

Galvanometer Scanner, Technology, DSP, 3 Dimension,  
2000Hz diode - pumped YAG.

<b>Standard equipment</b>	Main machine
	PC (Including dot cloud conversion software and engraving controlling software)
	User manual
	Protect glass
	Other accessories
	Graphic disc (1000 3D pictures)

- It adopts the advanced Galvano Technology together with 2KHz diode - pumped YAG frequency doubling laser which is faster, the laser point is more thin and bright, the image also will be more elaborate and lively.
- The key parts of the apparatus mainly come from Germany and the USA. It is more reasonable and steady for long - term production.
- The laser sub - surface engraving machine has original technology, and the engraving range can be up to 1500mm x 1000mm x 80mm (59" x 39" x 3.15").
- The warranty is valid for 1 year from the goods' arrival at Destination Port.

### ▼ Specifications



Model	LSEM-WLD-602C	
Laser Medium	Nd: diode - pumped (Can work more than 10000 hours)	
Laser Wavelength	532nm	
Laser Frequency	2000Hz	
Maximum Engraving Range	1500mm x 1000mm x 80mm (59" x 39" x 3.15")	
Maximum Engraving Speed	8000 - 10000dots / min	
Number of Laser Heads	1	
Maximum Power of the Whole Machine	1.5 KW	
Control System	Servo control system, Galvanometer Scanner, Technology, DSP, 3D	
Cooling System	Semiconductor Cooling	
Spare Parts	No	
Continuous Working Time	12hrs	
Electrical Connection	AC220v ± 10%, 50 - 60hz	
Dimension of the Whole Machine	1400mm x 2100mm x 1200mm (55" x 83" x 47")	
Weight of the Whole Machine	450kg	
Room temperature	15 - 35°C	
Engraving time	50mm x 50mm x 80mm	about 2 mins
	30mm x 20mm x 20mm	about 0.7 mins
<b>Price</b>	<b>≤ \$115,700</b>	

### ▼ Samples



## LCM-BY-Z1390 Series Laser Cutter

**High precision equilibrium linear guide ensures the precise processing effect, which can make delicate and complicated designs on acrylic, wood and PVC and so on for the advertisement, handicraft industries etc. Servo motor is optional in high - end applications.**

- 1300mm x 900mm (51" x 35") working area
- Up to 26" IPS (660cm / s) high working speed
- Pass - through front and rear doors to accommodate long work pieces
- Three unique protection functions, i.e. anti - interference function, water - protective function and power cut-off function ensure longer working life, safety and effectiveness.
- Laminated safety glass, glass viewing windows creating a safe enclosure for laser processing.
- Adopt the super fine cutting technology, which has features of extensive material processing, smooth cutting edge and burr-free, avoid polishing, processing high speed, high precision.
- Original Singapore imported lens with molybdenum base, making the equipment produce smaller facula and stronger cutting force, greatly improving working efficiency and reducing cost.
- Exhausting, absorbing and assistant blowing systems solve the problem that troubles the laser equipments manufacturing industry for years, extending the life of the laser tube.



CO2 laser tube



High-quality



Control box

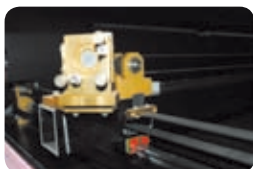

High precision equilibrium linear guide



Power source



Laser head



Interface

### ▼ Specifications

Model	LCM-BY-Z1390-80W / 100W / 150W
Maximum Cutting Area	1300mm x 900mm (51" x 35")
Laser Power	Glass tube 80W / 100W / 150W
Maximum Engraving Speed	660mm (26") / min
Maximum Cutting Speed	400mm (16") / s
Repeat Precision	0.006mm
Motor	Stepper motor
Power Support	AC110V - 220V, 50 / 60Hz
Machine Dimension	1765mm x 1610mm x 1100mm (69" x 63" x 43")
Machine Weight	340kg
Optional Device	Rotary fixture, electric lifting worktable, Imported Panasonic Servo Motor
Spare Parts	Reflective mirror, lens, and laser tube
<b>Price</b>	≤ \$4,628 (80W), ≤ \$5,289 (100W), ≤ \$6,033 (150W)

### ▼ Samples



## LCM-GL-ZDJG Series Auto Recognition Laser Cutter with contour cutting function

Nowadays printing technology is widely used in different industry such as banners, flags, sportswear and swimsuit. What is the best solution for cutting these printing fabric and textile? Laser cutting becomes the most popular solution for contour cut.

Cameras scan the fabric, detect and recognize printed contour, printing marks, or stripes and plaids fabrics, and send the cutting information to the cutting machine. The entire process is completely automatic and does not require operator intervention. This system can be adapted on cutters of any dimension.

**Applications:** Printing fabric & textile cutting (Banners & flags & all printing signs cutting, Sportswear & swim suit & all printing garments cutting); Strips & plaids cutting - Suit, T – Shirt; ARABESQUITIC CUTTING - garments, bags, suitcase, etc.

### ▼ CCD Camera



LCM-GL-ZDJG-9050



### ▼ Detect Method

#### Advantages of contour detection:

- No need original files
- Detect printing roll fabric directly without any preparation
- Fully automatic process, without human intervention
- Fast- 5 seconds for an entire cutting window recognize

#### Advantages of printing marks detection:

- High precision
- No limitation of space
- No limitation of color difference
- Compensate the materials distortion

### ▼ Specifications

Model	LCM-GL-ZDJG-9050	LCM-GL-ZDJG15090
Maximum Cutting Area	900mm x 500mm (35" x 20")	1500mm x 900mm (59" x 35")
Laser Power	CO2 glass tube 60W	Glass tube 100W (If only cut top layer of multi layer material need 60W)
Maximum Cutting Speed	500mm (20") / s	500mm (20") / s
Repeat Precision	0.1mm (0.004")	0.1mm (0.004")
CCD Camera Vision Area	150mm x 120mm (6" x 5")	150mm x 120mm (6" x 5")
Motor	Stepper motor	Stepper motor
Power Support	AC110V - 220V, 50 / 60Hz	AC110V - 220V, 50 / 60Hz
Machine Dimension	1300mm x 900mm x 1200mm (63" x 47" x 41")	2400mm x 1830mm x 1300mm (94" x 72" x 51")
Machine Weight	200kg	400kg
Optional Device	No	No
Spare Parts	Reflective mirror, lens, and laser tube	Reflective mirror, lens, and laser tube
<b>Price</b>	<b>≤ \$8,677</b>	<b>≤ \$10,798</b>

### ▼ Samples





## LCM-CM1309 Single / Double Heads Laser Engraving and Cutting System

### With Electric Up and Down Lifting Table, Rotary Fixture, 130W Tube and Servo Motor

Large worktable (51" x 35" x 10") and rear pass - thru allows easy the loading of materials such as bulk rolls or full 4' x 8' or 4' x 10' sheets.

With laser tubes of 130 Watts, this laser engraving and cutting machine is the best if you need high quality and high speed cutting and engraving on an area of 51 x 35 inches. Also, it can engrave pieces until 20 inches of height or cylindrical surfaces until 9 inches of diameter.

The Most Profitable Work Area: Two worktable sets 51" x 35" x 10" are included - Honeycomb to cut thinnest material (fabric, leather and paper, etc.), stripped to cut hard and inflammable materials (acrylic, wood and foam, etc.) and getting the cleanest edge cut.



### ▼ Applications

Signs, Awards and Trophies, Furniture and Frame, Cabinets, Engineering and Architecture, Custom Crates, etc.

Two 130W laser tubes and servo motors to get faster and better cutting and engraving: Acrylic, Plastics, Wood, Plywood, MDF, Foam, Cardboard, etc. Textile and Apparel, Shoes and Leather, Labels Manufacturing, Arts, Printing, etc.

Servo motors to get precision, transmission system of laser beam: Silicon mirrors 99% reflection, lens from the US for a clean cutting and engraving: Leather and Chamois, Any Fabric, Push, Tulle, Laserable Metal, etc.

Until 8 hours of training (2 days of 4 hours) in the Installation Maintenance & Operation of the Laser Machine, as well as the included software is available Free of charge in our premises in Los Angeles, California.



Control panel



Weels and stand support

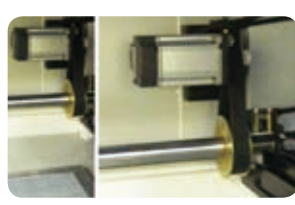
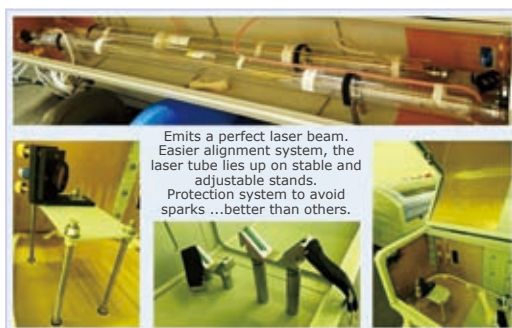

Servo motor

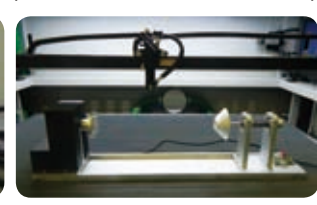

Rotary fixture



Laser head

### ▼ Specifications

Model	LCM-CM1309DH	LCM-CM1309SH
Maximum Cutting Area	51" x 35" (1300mm x 900mm)	1300mm x 900mm (51" x 35")
Laser Power	CO2 glass tube 130W (Normal lifespan: About 10000 working hours)	
Maximum Engraving Speed	1066mm / s (42IPS) (Depending the material to engrave)	
Maximum Cutting Speed	584mm / s (23IPS) (Depending the material to cut)	
Resolution	<=8000dpi	<=8000dpi
Motor	Servo motor	Servo motor
Lift Worktable	Yes	Yes
Power Support	AC 110V - 220V, 50 / 60Hz	
Machine Dimension	75" x 66" x 46" (1900mm x 1690mm x 1170mm)	75" x 66" x 46" (1900mm x 1690mm x 1170mm)
Machine Weight	904lb (410kg)	904lb (410kg)
<b>Price</b>	<b>≤ \$12,671</b>	<b>≤ \$11,019</b>

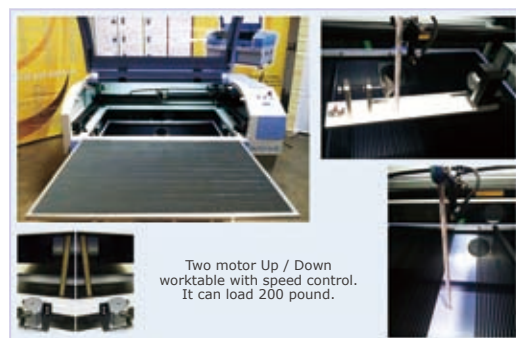

### ▼ Samples



## LCM-FB Series Flatbed Laser Cutter

It combines high volume production with personalization cutting; integrates laser mapping, adjusting, cutting, feeding and discharging materials functions, suitable for variety of textile, fabric and industrial flexible material.

- High volume production
- Unique advantages for process special materials such as seamless bonding, sponges, cutting of automobile air bags, inflatable play equipment, filter cloth, parachute, ski clothes, wedding dresses and protect supplies, etc.
- The working bed of the machine is very firm, with a strong loading capacity.
- The cutter is equipped with honeycomb working table, high quality focus lens and reflective mirrors.
- With special high-performance and constant temperature water chiller, it can auto adjust according to ambient temperature and keep the machine continuously working; ensuring cutting efficiency and reducing costs.
- This machine features a fine and smooth cut. The LCM-FB can perform jobs with tighten working range, without wasting much material and saving costs.
- Outstanding design equipped with servo motor driver, the laser transmits on large scale with the feature of simple and no waste; keeping the same power on each working spot, ensuring the cutting quality.
- The exhaust system can satisfy multiple cutting requests.
- The LCM-FB large format laser cutting machine adopts high quality CO<sub>2</sub> 80W glass laser tube made in China with a fine cutting effect and advantage of price.
- The machine comes with two sets of software, CSACE and Printing Driver.
- Pen type laser head, it is easy to adjust the focus, and it is also installed with gas blow device, which assures the laser head keep on doing working.
- The LCD display makes the laser cutting machine easy to operate and ensures your safety.



Knife shape aluminum rib worktable



CO2 laser tube



CW 5000 water chiller



Power source



### ▼ Specifications

Model	LCM-FB-2030	LCM-FB-1325A	LCM-FB-1325S
Maximum Cutting Area	2000mm x 3000mm (79" x 118")	1300mm x 2500mm (51" x 98")	
Laser Power	CO2 glass tube 80W		CO2 glass tube 80W
Maximum Cutting Speed	350mm (14") / s		350mm (14") / s
Resolution	<=4000dpi		<=4000dpi
Maximum Cutting Thickness	30mm (1.2") acrylic, 15mm (0.59") wood, 3mm (0.12") PE / plastic board		
Motor	Servo motor	Stepper motor	Servo motor
Power Support	AC110V - 220V, 50 / 60Hz		
Machine Dimension	2250mm x 3700mm x 1350mm (89" x 146" x 53")	1800mm x 2900mm x 1080mm (63" x 47" x 41")	
Machine Weight	720kg	650kg	
Optional Device	RF laser tube, 130W laser tube		
Spare Parts	Reflective mirror, lens, and laser tube		
<b>Price</b>	<b>≤ \$26,446</b>	<b>≤ \$15,426</b>	<b>≤ \$17,630</b>

### ▼ Samples



Acrylic model cutting



Wood model cutting



Wood decoration cutting



Wood veneer cutting

### LCM-GL-JG160100: Special Laser Cutter for Toy Fabrics and Automobile Decoration

This laser cutting machine especially suits for cutting plush toys and automobile decoration products.



- This machine has a thick ZINC honeycomb worktable with double reinforce central support. This ensures that large cutting areas would have the same high speed, stableness, cutting accuracy and clean edges as the small area machine.
- This cutter is equipped with a high quality water chiller, which can cool the laser tube, assuring the efficiency of cutting and being more convenient to maintain.

▼ Specifications

Model	LCM-GL- JG160100
Maximum Cutting Area	1600mm x 1000mm (63" x 39")
Laser Power	Glass tube 100W
Maximum Cutting Speed	600mm (24") / s
Repeat Precision	0.1mm (0.004")
Motor	Stepper motor
Power Support	AC110V - 220V, 50 / 60Hz
Machine Dimension	2400mm x 1830mm x 1300mm (94" x 72" x 51")
Machine Weight	430kg
Optional Device	CCD camera auto - recognition equipment
Spare Parts	Reflective mirror, lens, and laser tube
<b>Price</b>	<b>≤ \$8,442</b>

▼ Samples

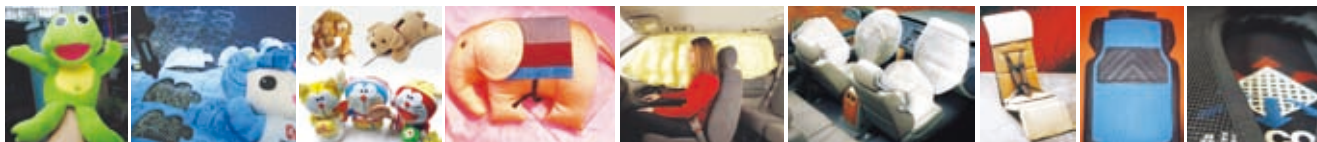

### LCM-GL-CJG160300: Large Format Fabric Flatbed Laser Cutter

Unique advantages for process special materials such as seamless bonding, sponges, cutting of automobile air bags, inflatable play equipment, filter cloth, parachute, ski clothes, wedding dresses, protect supplies, etc.

▼ Specifications

Model	LCM-GL-CJG160300
Maximum Cutting Area	1600mm x 3000mm (63" x 118")
Laser Power	CO2 glass laser tube 100W
Maximum Cutting Speed	600mm (24") / s
Repeat Precision	0.08mm (0.003")
Motor	Servo motor
Power Support	AC110V - 220V, 50 / 60Hz
Machine Dimension	4300mm x 2200mm x 1500mm (169" x 87" x 59")
Machine Weight	780kg
Optional Device	Auto feeder equipment, outside exhaust fans
Spare Parts	Reflective mirror, lens
<b>Price</b>	<b>≤ \$28,400</b>



▼ Samples

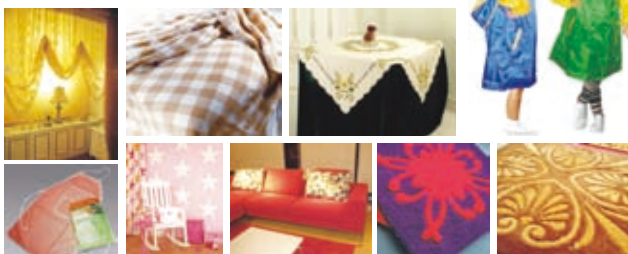

- High volume production.
- Equipped with vacuum absorb convey worktable, Japan YASKAWA servo motor, high - strength silicon and non - spherical focus lens imported from the world - renowned lens maker - the company's 26 U.S.
- With special high - performance and constant temperature water chiller, it can auto adjust according to ambient temperature and keep the machine continuously working; ensuring cutting efficiency and reducing costs.
- The machine combines batch production and personalized cutting, if it is equipped with feeding system, which can do auto and continuous process. The up exhaust and bottom absorb suction system make sure non-pollution and high quality process.
- It adopts specialized software, that compatible with kinds of file format, such as AI, BMP, PLT, DXF, DST and so on. It can meet demand for most of garment CAD design output in time, after the layout, it can graded automatically continuous output graphics that beyond the cutting format, can realize automatic continuous production if you choose auto - feeder system.

## LCM-MFB+ Series Double Ball Screw Metal and Nonmetal Laser Cutter

**Maximum Cutting Thickness: 40mm (1.57") Acrylic, 20mm (0.79") Wood, 1mm (0.04") Steel, 1mm (0.04") SS**

**This machine is used for DIE processing, printing packing, advertisement decoration, furniture, two - sided cellophane processing, crafts and gifts, wooden toy and sheet metal processing products industry, etc.**

**Applicable Materials** - Metal, Die board, wood, acrylic, perspex, MDF, leather and composite material, etc.

**This machine adopts Recyclable Original British GSI 200W Laser system, which can be used above 10,000 hours. After 10,000 hours, it can be inflated three times. Relatively low post-production cost.**



Water chiller



Panasonic servo motor

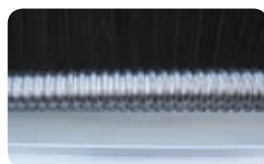

Ball screw transmission



GSI 200W laser tube



Laser head



Control panel handle



LCM-MFB+-1325

- Produced under the international quality management system, LCM-MFB+ series laser equipment completely exemplify world first - class technical level from stability, precision and speed.
- Well - equipped, this series laser machines will be a new processing method for field processing industries. In other words, it's the successful carrier for users in processing industries.
- In order to meet the needs of high precision cutting, two pieces of Y-axis apply of LCM-MFB+ ball screws combined with high precision linear rails. Meanwhile, X - axis puts ball screws to use combined with high - precision driving mode. What is more, the 200W laser tube is equipped with GSI and the steady performance of laser power supply.
- The large size work table is forged safe and steady to the working platform to assure its stability and precision when it working.
- The motion system makes use of linear rails and imported high speed Panasonic servomotor combined with ball screws to assure the processing speed and precision.
- The worktable using special processed knife cutting platform. It's helpful to obtain perfect cutting effect and improve productiveness.

### ▼ Samples

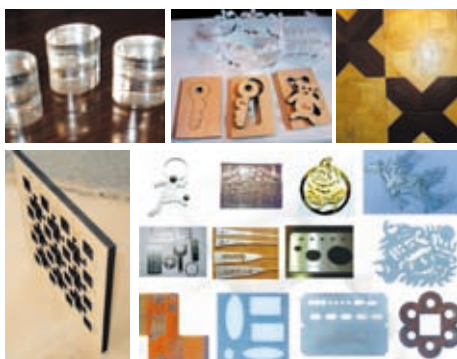

### ▼ Specifications

Model	LCM-MFB+-1318	LCM-MFB+-1325	LCM-MFB+-1525
Maximum Working Area	1300mm x 1800mm (51" x 71")	1300mm x 2500mm (51" x 98")	1500mm x 2500mm (59" x 98")
Laser Power	England GSI CO2 sealed 200W		
Maximum Cutting Speed	300mm (12") / s		
Highest Scanning Precision	2500DPI		
Locating Precision	≤±0.01mm		
Supported Graphic Format	PLT, BMP, DXF, AI, DST,		
Laser Output Control	1 - 100% software setting		
<b>Price</b>	≤ \$43,811	≤ \$48,200	≤ \$50,000



## LCM-JSQG Series Metal Laser Cutter

The metal laser cutter is mainly used for the thin stainless iron & steel cutting in the sheet metal industry and the letters' cutting (Like stainless steel and titanium letters) in the sign industry.

It adopts ND: YAG medium, special designed flying light route system, high precision ball screw gantry structure working table

Stable light route with high precision and quick process speed

The cutting machine can achieve smooth edges, with few hot distortion and small cutting slot from the straight side.

It adopts CNC controlling technology with professional software, which can supports AI, BMP, PLT, DXF file formats, and it is easy to operate.

This metal laser cutting machine has great advantages in metal - cutting. It will work immediately when switched on, which is energy - saving and quite convenient to operate.

**Applicable Metal:** brass, carbon steel, stainless steel, copper, titanium and ceramics etc.

### ▼ Samples



Metal round pipe cutting



Metal components cutting



Large format metal plate cutting



Kitchen ware cutting

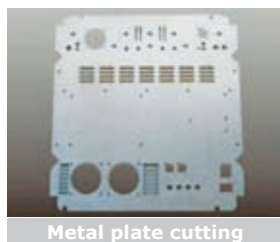

Metal plate cutting



Case and cubical cutting



Elevator panel cutting

### ▼ 500W / 650W Metal Laser Cutter Maximum Cutting Thickness and Speed

Material	Cutting Thickness	Maximum Cutting Speed (500W)	Maximum Cutting Speed (650W)	Maximum Cutting Speed (800W)	Cutting Line Width	Auxiliary Gas
Stainless Steel	1mm	24 - 30mm / s	24 - 30mm / s	40mm / s	0.3mm	Air
	2mm	13 - 18mm / s	15 - 20mm / s	24mm / s	0.4mm	Air
	3mm	7 - 10mm / s	10 - 15mm / s	18mm / s	0.5mm	Air
	4mm	3 - 5mm / s	6 - 9mm / s	13mm / s	0.5mm	Air
	5mm	2 - 4mm / s	5 - 8mm / s	9mm / s	0.6mm	Air
	6mm	1 - 3mm / s	3 - 5mm / s	8mm / s	0.8mm	Air
	8mm	/	/	3mm / s	1mm	Air
Steel	1mm	25 - 30mm / s	25 - 30mm / s	35mm / s	0.3mm	Air
	2mm	15 - 20mm / s	18 - 22mm / s	25mm / s	0.4mm	Air
	3mm	9 - 12mm / s	13 - 17mm / s	16mm / s	0.5mm	Air
	4mm	4 - 6mm / s	10 - 15mm / s	12mm / s	0.5mm	Air
	5mm	3 - 5mm / s	6 - 10mm / s	7mm / s	0.5 - 0.8mm	Air
	6mm	2 - 4mm / s	4 - 7mm / s	6mm / s	0.6 - 0.8mm	Air
	8mm	1 - 0.8mm / s	1 - 3mm / s	2mm / s	0.8 - 1mm	Air
Aluminum	1mm	10 - 15mm / s	15 - 20mm / s	50mm / s	0.3mm	Air
	2mm	6 - 10mm / s	10 - 15mm / s	21mm / s	0.4mm	Air
	3mm	2 - 5mm / s	4 - 8mm / s	13mm / s	0.5mm	Air
	4mm	/	/	6mm / s	0.6mm	Air
Brass	1mm	10 - 15mm / s	15 - 20mm / s	17mm / s	0.3mm	Air
	2mm	6 - 10 mm / s	10 - 15mm / s	15mm / s	0.4mm	Air
	3mm	2 - 5mm / s	3 - 7mm / s	10mm / s	0.5mm	Air

**Remark:** Use Oxygen, the cutting speed can improve up to 20 - 30%.

## LCM-JSQG-130250 / 150300 the 5<sup>th</sup> YAG Metal Laser Cutter

- Gantry design. The short distance between the material and the optical laser let to not lose energy during transmission, ensuring the same result in the entire cutting area.
- The cutter can achieve a clean and smooth cutting edge so you don't need to post process the material after cutting.
- The LCD screen control system makes easy to operate, just need to connect the computer with the machine using a USB cable and download the images.
- The laser lens choose USA high focus, high penetrability, high quality focus lens.

YAG Laser Source; Collision Protection laser head;  
YASKAWA; High Frequency Laser Power Supply  
Ball Screw and Linear guide transmission,  
centralization lubrication;  
Professional Water Chiller  
Generation 5 machine Design  
Laser Cutting and Nesting software

**Collision - protection laser head**  
**Electrical cooling system**  
**Professional water chiller**  
**Full cover drag chain**  
**Centralization lubrication**  
**Collecting drawer**



### ▼ Specifications

<b>Model Name</b>	<b>LCM-JSQG-130250 / 150300</b>	
Travel Method	Stationary table, Gantry style	
Control Method	X, Y axis motorized controlled	
Travel Amount	X-axis	1300mm (51") / 1500mm (59")
	Y-axis	2500mm (98") / 3000mm (118")
	Z-axis	18mm (It's standard) customized by requirements
Feed Rate	X-axis	2500mm (98") / s <sup>2</sup>
	Y-axis	2000mm (79") / s <sup>2</sup>
Rapid Speed	X-axis	800mm (31.5") / s
	Y-axis	600mm (23.6") / s
Maximum Worksheet Loading Capacity	300kg	
Repeatability Positioning Accuracy	0.01mm	
Least Command Increment	0.002mm	
Drive Feed Method	Position control / AC servo motor	
Machine Table Height	600mm (24")	
Power Supply (Only for machine)	380V, 50Hz	
<b>Laser Oscillator</b>		
Laser Oscillation Method	Lamp pump YAG	
Laser Output	Output (Rated)	500W / 650W / 800W
	Stability	3%
	Frequency	1 - 300Hz
	Wavelength	1064nm
Output Beam	Mode	multi mode
	Diameter	0.1mm after focus
<b>CNC Control Unit</b>		
CNC Unit	Yaskawa AC servo motor	
CNC Control Method	Semi - close loop control	
Control Functions	X, Y Controlled (Simultaneously controlled)	
Input Method	USB, Net port, memory stick	
Least Input Increment	0.02mm	
Minimum Position Detection Accuracy	0.02mm	
Program Storage Capacity	128M flash memory in machine	
Operating Modes	Windows xp support	
Display Function	Cutting process, Position information, Parameters, Design monitor	
I / O Interface	RS232C	
Display	5 inch screen display	
<b>Price</b>	<b>≤ \$52,600 / ≤ \$54,450 / ≤ \$59,800</b>	



## LCM-LFB-320800 Series Large Size Flatbed Laser Cutter, Outdoor Industrial Fabric Cutting

Laser machine adopts non - contact process way for cutting industrial material with high temperature heating, slim cutting edge, and very accurate contours without applying any force, mechanical fixing and punching is not required.

### Large Format Cutting Tables and System

Certificate: ISO9001, CE certificate (European Security Certificate), etc.

Mainly used to cut inflatable outdoor product, air balloon, rescue boat materials, tent, parachute, sailboat material, coated fabric, and rubber boat, etc.



- It adopts vacuum conveyer working table, auto - feeder for choice to feeding the material continuous cutting;
- It selects servo controlling motor for large area cutting smoothly. The speed is 0 - 48000mm / min;
- Following laser power adjustment when curve or arch design processed, ensure the same result under the condition of shift gears;
- It has upper exhaust system, and bottom vacuum exhaust absorption to ensure the material is very flat with the table;
- The cooling recycle system is selected water chiller for cooling the laser source and ensures the machine working efficiently;
- The software support format is compatible with BMP, AI, PLT, DST, and DXF. Combined with CAD typeset designs and output in time.

### ▼ Specifications

Model	LCM-LFB-320800	LCM-LFB-320800-RF
Maximum Cutting Area	3200mm x 8000mm (126" x 315")	
Laser Power	130W CO2 glass laser	150W CO2 R. F. metal laser
Working speed	0 - 48000mm (1890") / min	
Control system	Nesting offline control, 5 inch display	
Cooling mode	Water chiller cooling system	
Power supply	AC220V ± 5% / 50Hz	
Positioning Accuracy	+ / - 0.1mm	
Software Support File	BMP, AI, PLT, DST, DXF	
Machine Dimension	10370mm x 4460mm x 1560mm (408" x 176" x 61")	
Machine Weight	8620kg	
<b>Price</b>	≤ \$115,702	≤ \$82,644



Outdoor industrial fabric cutting



Automotive upholstery

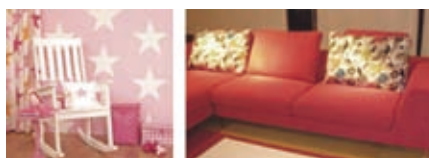

Furniture interior cutting



Inflatable boat cutting



Pvc tarpaulin cutting



Inflatable products making

**We provide four kinds of laser markers for you, they are CO2, YAG pump, Diode pump and Fiber laser.**

**About CO2 Laser Marker**

The carbon dioxide laser (CO2 laser) is still one of the most useful lasers. A CO2 laser beam is not easily absorbed by metal, but can easily be absorbed by many organic materials such as wood, acrylic, rubber, etc,



**About YAG Laser Marker**

The lamp - pump laser marking machine adopts the galvanometer scanning system. To achieve the purpose of marking, it adopts the 1064 nm wavelength solid YAG laser and galvanometer to control the laser deflection. The wavelength of a YAG laser (1.064 microns) is exactly ten times smaller than the CO2 wavelength of 10.64 microns, which makes it ideally suited for absorption in most metals, but this small wavelength inhibits its ability to be absorbed by many other materials (Wood, acrylic, plastics, fabrics, etc.)

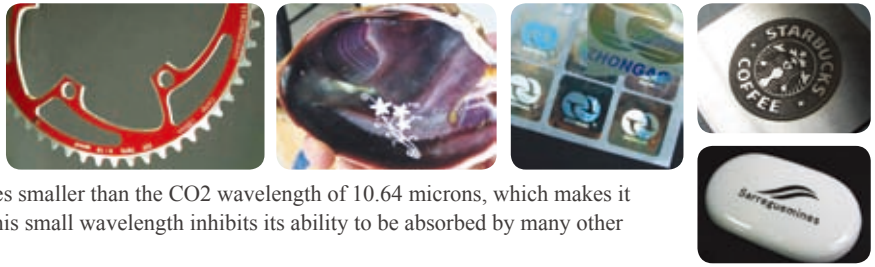

**About Diode Pump Laser Marker**

Diode Laser Marker rapid solid - scanner laser marking machine has rapid - scanner galvanometer, driver, scanner - focusing lenses, etc., which are provided by leading manufacturers from Europe and America. It has the high performance, quality and reliability, especially for mass and large - scale production. It has the advantages of high precision, fast marking speed, long life performance, compact construction, low maintenance and convenient operation, etc.



**About Fiber Laser Marker**

Fiber lasers are a great leap forward in laser technology. The fiber lasers are more easily integrated into industrial processes in comparison with conventional lasers. It is a equipment does not need constant temperature and humid. No consumables, easy maintained. You can use the machine for a long time.

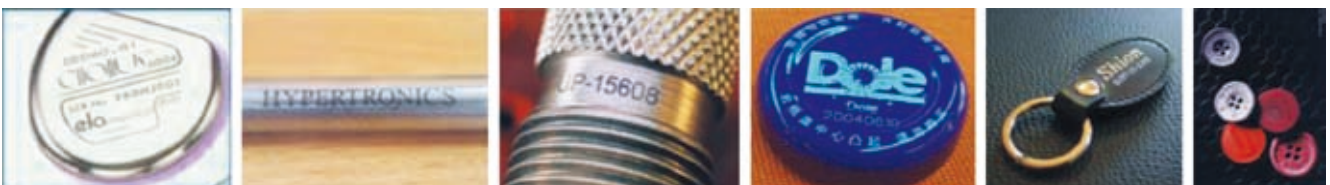
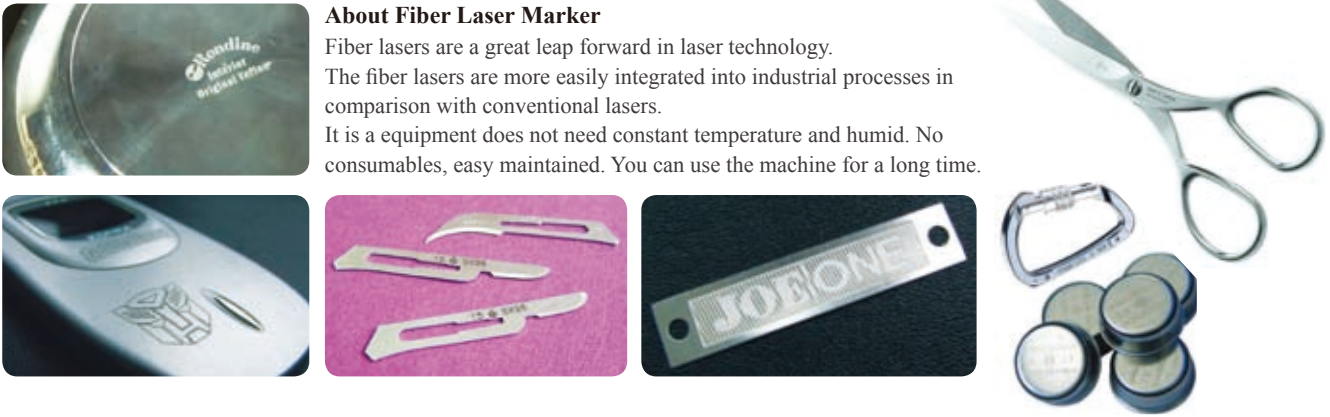



## LMM-GL-DBD50-S: YAG Lamp-pump Metal Laser Marking Machine - 50W

This machine can mark number or graphic on metal (Include rare metal), plating material, filming-plating material, spray dope material, plastic, and rubber, colophony, pottery, etc.

It could be applied to vehicles, motor spare parts, space and aviation instruments, integrate circuit, food packing, beverages, tobacco, mobile bottom, battery, electro instruments, computer fitting and outside devices, hardware tools, stainless steel instruments, horologe and jewelry, industrial axletree, electrical wire and cable, apparel garishly and other pattern fields with marking characters.

### ▼ Specifications

Model	LMM-GL-DBD50-S
Laser Medium	YAG
Laser Output Power	50W
Laser Frequency	0 - 50KHz (Adjustable)
Q Adjust Method	Sound - optical Q - switch
Marking Range	70mm x 70mm (3" x 3") (Optional Range: 110mm x 110mm (4" x 4"), 175mm x 175mm (7" x 7"))
Maximum Marking Depth	0.01 - 0.2mm (0.0004" - 0.0078") (Depend on the material)
Maximum Line Marking Speed	7000mm (276") / s
Minimum Line Width	0.02mm (0.0007")
Minimum Marking Character	0.3mm (0.012")
Repeat Precision	±0.002mm (0.0001")
Laser Capability Control Software	1-100% manipulating and software setting Laser high speed controlling software
Support Image Format	PLT, AI, DXF, BMP and other universal format
Cooling Method	Water cooling and protection system
Power Support	100V - 240V, 380V, 50Hz / 60Hz
Main Components	Control cabinet, cooling system and main power
Spare Parts	Krypton Lamp, it can be used for 300 - 500 hours
<b>Price</b>	<b>≤ \$12,546</b>



- High resolution, fine pattern and cost - effective.
- Core parts take an imported ceramic cavity reflection, with high energy efficiency which extend the lifespan of the krypton lights up to 2 or 3 times more. The laser threshold is a low cost excellent beam quality and easy to maintain.
- High relocation and location accuracy, high repeatability that never fades.
- It has a more competitive price that the Diode pumps.
- It supports different file formats; with a powerful system that has a random array that can mark letters and number in the design at the same time.
- It is equipped with an industrial water chiller, to accomplish the cleaning requirements of the laser. The water tank and water pump of the cooling system, are made of stainless steel and are sealed up totally in order to prevent dust to fall into the tank and is able to endure the erosion.

## LMM-GL-DBEC50-S: YAG Semiconductor Laser Marking Machine - 50W

**Application:** Automobile, integrated, circuit (IC), electronic components, silicon slice, electronic production, electric equipment, communication, ornaments, art crafts, PVC materials etc.

The laser marker machine can mark on many kind of material, including metal and non-metal materials.

It is widely used for high precision marking, plastic keys, mobile phones and keyboard, etc.

- With high marking speed (Up to 7000mm (276") / s )
- Imported high quality diode pumped ND YAG laser, with photoelectric and efficiency conversion. The laser is reliable with an extraordinary output, stability in power and high accuracy at marking.
- Compared with traditional lamp pump marking laser machine, the lifespan can be extend 20 times more, energy consumption is reduced up to 75%.
- It has advanced hardware, technology control and intelligent software operation system.
- The laser generator, power supply, working table are all in one structure that is easy to operate. The working table can be made according to production need.
- The lifecycle of the Diode pump is about 16000 hours, it can be used for a long time.
- It is equipped with an industrial water chiller, to accomplish the cleaning requirements of the laser. The water tank and water pump of the cooling system, are made of stainless steel and are sealed up totally in order to prevent dust to fall into the tank and is able to endure the erosion.



### ▼ Specifications

Model	LMM-GL-DBEC50-S
Laser Medium	Diode pumped
Laser Frequency	200Hz - 50KHz (Adjustable)
Laser Output Power	50W
Q Adjust Method	Sound-optical Q-switch
Marking Range	70mm x 70mm (3" x 3") (Optional Range: 110mm x 110mm (4" x 4"), 175mm x 175mm (7" x 7"), 220mm x 220mm (9" x 9"), 300mm x 300mm (12" x 12"))
Maximum Marking Depth	0.01 - 0.2 mm (0.0004" - 0.0078") (Depend on the material)
Maximum Line Marking Speed	7000mm (276") / s
Minimum Line Width	0.02mm (0.0007")
Minimum Marking Character	0.1mm (0.0039")
Repeat Precision	0.002mm (0.00008")
Software	Special English marking software
Support Image Format	PLT, AI, DXF, BMP, and other universal format
Cooling Method	Water cooling and protection system
Power Support	AC220V ± 10%, 50 - 60Hz
Main Composing	Control cabinet, cooling system and main power
Optional Device	Rotary system
<b>Price</b>	<b>≤ \$16,115</b>



## CNCR-LD-1325CCD: CCD Digital Flatbed CNC Cutter

This digital cutting bed is mainly used in sign & graphics, Digital printing, packaging, automotive, aerospace, HVAC industries. It can cut cardboard, Graphic board, vinyl, acrylic, aluminum, Leather, Garpet, carbon composite, cork, Expandable PVC, foam, fabric, Gator Foam, corrugated plastic, paper, closed cell foam, HVAC dust liner, rubber - silicon and rubber mat.

- Innovation, tangential cutting, camera capturing and positioning
- Printing finishing, best combination of printing and cutting industries
- Low cost and high performance, well considering for price sensitive users
- Full cast iron body, imported linear guides, rack & gear scientifically installed and adjusted by experienced engineers.



- Make colorful 3D signs and advertisings simply.
- Multi - exchangeable tangential tools for finishing cutting on soft media of various thicknesses.
- High power spindle processes common hard materials easily.
- New generation vacuum bed with excellent flexibility, higher power and much lower noise
- Leading pneumatic and hydraulic structures demonstrate new trends perfectly
- Driven by Japanese servo motors with outstanding speed and durability.
- Friendly HMI, easily compatible with Windows98 / NT / 2000 / XP / Vista. Original CAD / CAM English software.
- English manual, scheduled online training coursed by English speaking experts and free technical guides make the using of machine most enjoyable.

The tool head has 2tool holders: A cutting blade + a router bits + one holder for CCD camera



Two tool heads + i - cut camera



Cutting blade

### ▼ Specifications

Model	CNCR-LD-1325CCD
Maximum Engraving Area	1300mm x 2500mm (51" x 98")
Spindle Power	1.5KW inverter - driven spindle motor cooled by water.
Travel Speed (X, Y, Z axes move together )	50m (1968") / min
Instruction Resolution	0.01mm (0.0004")
Repeat Precision	0.1mm (0.004"), registration and compensation: I - cut vision
Engraving Tools	Ø3.175 or Ø6.00
Rotational Speed of Spindle	6000 - 24000rpm
Height From Gantry to Worktable	130mm (5")
CNC Controller	DSP
Engraving Software	American software - ICUT
Type of Driving Motor	Japanese Servo motor
Type of Worktable	New generation vacuum bed
Interface	USB
Instruction Format	G code or HPGL
Power Consume	4000W
Cooling Method	Water - cooling (you can choose air - cooling)
Power Supply	AC110V - 240V, AC380V, 50Hz / 60Hz. Please tell us your country before you make an order
Spare Parts	Cutter
Machine Dimension	2900mm x 1440mm x 1400mm (114" x 57" x 55")
Machine Weight	1000kg
<b>Price</b>	<b>≤ \$38,100</b>

### ▼ Main Configuration

**Maximum Working Area:** 1300mm x 2500mm (51" x 98")  
**Worktable Size:** 1320mm x 2900mm (52" x 114")  
**Height from Gantry to Worktable:** 130mm (5")  
**Max. Travel Speed:** 50m (1968") / min  
**Cutting Heads:** Two Tool Heads + I - cut camera  
**Maximum Tool Force:** 20kg  
**Registration and Compensation:** I - cut vision  
**Driving System:** Servo motor  
**Electric Power:** 4000W  
**Power Supply:** AC220V / 50Hz  
**Engraving Software:** American software I - cut  
**Engraving Tool:** 5pcs of engraving bits and 5pcs of cutting blade

## CNCR-LD Series Desktop CNC Engraver

It is possible to process any wooden products and advertising sign plate, acrylic board / sheet.

Any metal or non - metal material can be processed, for example, iron, copper, aluminum, plastic plate, wood, jade, etc.

- DSP controlling system, easy operation, sturdy, reasonable price, multi-functions and wide ranges of application.
- Unique intelligent calculation fully develops the potential of the engine and leads to high processing speed, the synchronization of curves and straight lines, and more smooth curves
- USB interface enables data to be transmitted in a second supports hot plug.
- Be compatible with various CAD / CAM software, such as Type3 / Artcam/Casmate / Proe / UG / Artgrave etc.
- It is able to go on engraving when the electricity is cut or the tool is broken.



CNCR-LD-6030H

CNCR-LD-3020HA(J)



### ▼ Specifications

Model	CNCR-LD-3020HA	CNCR-LD-3020HJ	CNCR-LD-3020HM	CNCR-LD-6030H
Description	For AD. industries	For jade products processing (With water circulation system)	For metal stamp engraving (With metal stamp clamp)	For AD. industries
Maximum Engraving Area		300mm x 200mm (12" x 8")		600mm x 300mm (24" x 12")
Travel of Z axis		55mm (2")		55mm (2")
Spindle Power		800W water cooling		800W water cooling
Resolution		0.01mm (0.0004")		0.01mm (0.00039")
Maximum Travel Speed		6mm (236") / min		6mm (236") / min
Engraving Tool Dia.		3.175, 6.00mm		3.175, 6.00mm
Engraving Software		UcanCAM V9		UcanCAM V9
Machine Dimension		650mm x 450mm x 600mm (26" x 18" x 24")		820mm x 600mm x 600mm (32" x 24" x 24")
Machine Weight		45kg		68kg
<b>Price</b>	≤ \$2,250	≤ \$2,560	≤ \$2,450	≤ \$2,680

## CNCR-RS Series Desktop CNC Router



Economical

Small and simple structure under the special spindle design

Various materials can be applied by the machine, such as PVC, Acrylic, wood, PCB, even some soft metal like aluminum and copper.

Besides, all the machines are equipped with DSP handle and USB connection, which will bring great convenience by reading USB memory directly (Ncstudio and Mach 3 are also good choices).

In addition, the machine can achieve the performance of good resolution and less noise with ball screw.

### ▼ Specifications

Model	CNCR-RS-3020	CNCR-RS-4060
Maximum Engraving Area	300mm x 200mm (12" x 8")	385mm x 580mm (15" x 23")
Travel of Z axis	55mm (2.2")	55mm (2.2")
Spindle Power	800W water cooling	800W water cooling
Resolution	0.01mm	0.01mm
Maximum Travel Speed	4m (157")/min	4m (157")/min
Engraving Tool	φ 3.175 , φ 6	φ 3.175 , φ 6
Motor	Stepper motor	Stepper motor
Machine Dimension	550mm x 650mm x 550mm (22" x 26" x 22")	900mm x 700mm x 550mm (35" x 28" x 22")
Machine Weight	39kg	59kg
<b>Price</b>	≤ \$1,580	≤ \$1,950



## CNCR-M40 ABC: Small CNC Engraving Machine with Touch Screen, no computer is required

**This small CNC engraving machine, as simple as ABC, 123**

**Applications:** Small signs, doorplate, breastplate, 2D plate engraving; Technical plates and safety sign.

### A / A complete plug and start engraving equipment

Easy to use standalone engraving solution

For production of technical plates and safety signs

Multi - purpose, the engraving machine engraves on plastic and metallic material up to sizes 305mm x 210mm (12" x 8.3").

This reliable and robust equipment includes everything that is necessary to start engraving: Machine, design software, cutters.



### B / A tactile interface, simple and intuitive

The user interface is included in the solution, no computer is required. The CNC engraving machine's software is supported by a tactile screen allowing the design of plates with lines of text, logos and drawings. The files are saved on a SD card.



Red laser pointer simulates the engraving job - no measuring required.

### C / An affordable solution to diversify your services.

Very compact, the M40ABC can be set up in any professional environment, simple and fast on - site engraving widens the scope of services to offer without having to subcontract.

#### ▼ Specifications

Model	CNCR-M40 ABC
Maximum Engraving Area	305mm x 210mm (12" x 8.3")
Table Surface (Table in option)	330mm x 260mm (13" x 10.2")
Maximum Flatness (Vice)	0.3mm (0.01")
Z Maximum Clearance (Table spindle)	35mm (1.4")
Z Maximum Clearance (Vice spindle)	50mm (2")
Z Spindle Travel	40mm (1.57")
Automatic Z Ref.	Yes
Maximum Vice Opening	225mm (8.9")
Maximum X. Y Working Speed	25mm / s (0.98" / s)
Maximum X. Y off - load Speed	40mm / s (1.57" / s)
X. Y Engraving Precision	<0.1mm (0.004")
Engraving Repeatability	<0.05mm (0.002")
Kind of Spindle	Rotating / top loading
Cutter Diameter	4.36mm (11/64")
Maximum Rotation Speed	2000rev / min
Speed Regulation	No
Output	50W
Depth Regulating Nose	Compatible with all the depth regulating noses
Operation Temperature	Min. +5°C; Max. +40°C
Storage Temperature	Min. -5°C; Max. +45°C
Degree of Relative Moisture When in use	20 to 80%
Power Supply	AC 100 - 240V, 50 / 60Hz
<b>Price</b>	<b>≤ \$8,790</b>



#### ▼ Samples

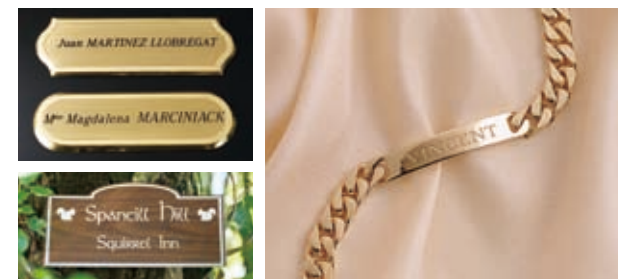

## CNCR-LD-1325HX: Woodworking CNC Engraver

Strong and sturdy, for a durable reliable performance  
 Easy operation at a reasonable price  
 Multi-functions and wide range of application make it possible to process any wooden products, advertising sign plates, acrylic cutting, etc. Any metal or non - metal material can be processed, for example: iron, copper, aluminum, plastic plate, wood, etc.

### ▼ Main Configuration Information

**Available Engraving Area:** 1300mm x 2500mm (51" x 98")

**Height of Gantry Lift:** 120mm (4.7")

**Maximum Travel Speed:** 24m (945") / min

**Spindle Power:** 4.5KW Chinese air cooling

**Machine Body:** Aluminum - alloy table + protective table top

Gear wheel transmission in Y direction, dual engines and high - power driver guarantee the speed and power. Z direction adopting bolt pole transmission ensures the precision in processing.

X, Y, Z axis adopt German liner rail.

16 pcs engraving tools, DSP (USB interface)

**Software:** Type3 or UcanCAM V9.

### ▼ Samples



### ▼ Specifications

Model	CNCR-LD-1325HX
Maximum Engraving Area	1300mm x 2500mm (51" x 98")
Travel of Z axis	120mm (4.7")
Spindle Power	4.5 KW inverter - driven spindle motor cooled by water
Resolution	0.01mm
Maximum Travel Speed	24m (945") / min
Engraving Tool Dia.	3.175, 6, 4mm (optional)
Machine Dimension	2900mm x 1500mm x 1450mm (114" x 59" x 57")
Machine Weight	1000kg
<b>Price</b>	<b>≤ \$6,650</b>



## CNCR-LD-HS Series Stone and Glass CNC Router



This CNC stone engraver is the upgraded model from CNCR-LD-1318H, specially designed for stone and glass engraving. Wide range of application makes it possible process stone products and any metal materials, for example, iron, copper, aluminum, plastic plate, wood, etc. It is a machine to operate with multi - functions, and sturdy but with reasonable & affordable price.

### ▼ Main Configuration Information

**Engraving area:** 1300mm x 1800mm (51" x 71")

**Height of Gantry Lift:** 120mm (4.7")

**Maximum Travel Speed:** 30m (1181") / min (DSP)

**Spindle Power:** 2.25KW

**Power Supply:** 220V, 50Hz

**Machine Body:** Water cooling circulation system + spray nozzle

Gear wheel transmission in Y direction, dual engines and high-power driver guarantee the speed and power. X, Z direction adopting bolt pole transmission ensures the precision in processing

16 pcs engraving tools, DSP (USB interface)

### ▼ Specifications

Model	CNCR-LD-1318HS
Maximum Engraving Area	1300mm x 1800mm (51" x 71")
Spindle Power	2.2KW inverter - driven spindle motor cooled by water.
Maximum Engraving Speed	10m (394") / min
Instruction Resolution	0.01mm (0.0004")
Repeat Precision	0.1mm (0.004")
Engraving Tools Dia.	3.175mm, 6.00mm
Rotational Speed of Spindle	6000 - 24000rpm
Type of Driving Motor	Stepper motor
Power Supply	AC110V - 240V, AC380V. 50Hz / 60Hz
Machine Dimension	1600mm x 1400mm x 1450mm (63" x 55" x 57")
Machine Weight	360kg
<b>Price</b>	<b>≤ \$5,370</b>



Stone engraving



Acrylic engraving



Aluminum cutting



Glass engraving

## CNCR-CP-Y Series High Precision AD CNC Engrave

CNCR-CP-Y series engraving machine, is released for the sign advertising industry with a high performance / cost ratio. It has a new look, fast speed and high precision. It comes with DSC control system, HD LCD screen, and friendly interface.

Double Y axis engraving machine, the latest model, is accurate as screw machines and fast as rack and pinion engraving machines.

**Maximum Travel Speed:** 7200mm (283") / min or 25000mm (984") / min (Double Y axis)

**Spindle:** 1.5KW / 2.2 Chinese air cooled

10 pcs engraving tools, circular guideway, Leadshine drivers

3.5" DSC-931 Color screen controller, stepper motor



- It can work offline. New look, fast speed and high precision
- It uses a high speed USB 2.0 connector and can transfer at speeds up to 12MB / second.
- There is an Ethernet connector and a large internal memory, making it easy to download data.
- The new digital analog converter makes it much easier to change the speed of the spindle via the controller. The controller uses DSC technology, enhancing data processing speed.
- When the job mixes straight lines and arcs, it will make the output very smooth.
- The new controller has the same previous functions such as cutting at an angle for smoother cuts, power failure memory of the last point, restarting the job at any line, etc.
- The system has many advanced functions like ramp entry, power-off memory, restarting at any line. And also many processing modes like professional modes including Constant speed cutting, 2D mode, 3D mode, Duplicate Mode, Mirror Image Mode, Scanning Mode Drilling Mode and custom mode.
- This series engraving machine has "Cutting at angle" function with DSC control system. "Cutting at angle" can make less chance of work piece coming loose and no trace marks. (When the tool comes to the corner, but not to the bottom, workpiece come loose quite often). More details of "Cutting at angle" function operation, please see software manual.

### ▼ Specifications



Model	CNCR-CP-6590	CNCR-CP-1208	CNCR-CP-1212	CNCR-CP-1318
Precision Repeatability	± 0.02mm	± 0.02mm	± 0.02mm	± 0.03mm
Maximum Engraving Area	650mm x 900mm (25.6" x 35")	1200mm x 800mm (47" x 31")	1200mm x 1200mm (47" x 47")	1300mm x 1800mm (51" x 71")
Spindle Power	1.5KW Chinese air cooled	1.5KW Chinese air cooled	1.5KW Chinese air cooled	1.5KW Chinese air cooled
Spindle Rate	24000r / min	24000r / min	24000r / min	24000r / min
Cutting Tool Diameter	Φ3.175, Φ4, Φ6, Φ8	Φ3.175, Φ4, Φ6, Φ8	Φ3.175, Φ4, Φ6, Φ8	Φ3.175, Φ4, Φ6, Φ8
Travel of Z Axis	110mm (4.3")	110mm (4.3")	110mm (4.3")	110mm (4.3")
Maximum Movement Speed	7200mm (283") / min	7200mm (283") / min	7200mm (283") / min	7200mm (283") / min
Working Table Size (X, Y)	720mm x 1270mm (28" x 50")	1280mm x 1340mm (50" x 53")	1360mm x 1650mm (53.5" x 65")	1360mm x 2270mm (53.5" x 89")
Voltage	AC220V ± 10%, 50Hz	AC220V ± 10%, 50Hz	AC220V ± 10%, 50Hz	AC220V ± 10%, 50Hz
Consumption	2.5KW	2.5KW	2.5KW	2.5KW
Engraving Software	Type3	Type3	Type3	Type3
Interface	USB / Ethernet	USB / Ethernet	USB / Ethernet	USB / Ethernet
Type Of Worktable	Aluminum slot	Aluminum slot	Aluminum slot	Aluminum slot
<b>Price</b>	<b>≤ \$4,370</b>	<b>≤ \$5,080</b>	<b>≤ \$5,550</b>	<b>≤ \$6,500</b>

## &gt; Engraving &amp; Cutting Machine &gt; CNC engraver &amp; router

## ▼ Specifications



Model	CNCR-CP-1325Y	CNCR-CP-1530Y	CNCR-CP-2030Y	CNCR-CP-2040Y
Precision Repeatability	± 0.05mm	± 0.05mm	± 0.05mm	± 0.05mm
Maximum Engraving Area	1300mm x 2500mm (51" x 98")	1500mm x 3000mm (59" x 118")	2000mm x 3000mm (79" x 118")	2000mm x 4000mm (79" x 157")
Spindle Power	2.2KW Chinese air cooled	2.2KW Chinese air cooled	2.2KW Chinese air cooled	2.2KW Chinese air cooled
Spindle Rate	24000r / min	24000r / min	24000r / min	24000r / min
Cutting Tool Diameter	Φ3.175, Φ4, Φ6, Φ8	Φ3.175, Φ4, Φ6, Φ8	Φ3.175, Φ4, Φ6, Φ8	Φ3.175, Φ4, Φ6, Φ8
Travel of Z Axis	110mm (4.3")	110mm (4.3")	110mm (4.3")	110mm (4.3")
Maximum Movement Speed	25000mm (984") / min	25000mm (984") / min	25000mm (984") / min	25000mm (984") / min
Working Table Size (X, Y)	1360mm x 3030mm (53.5" x 119")	1600mm x 3730mm (63" x 147")	2100mm x 3730mm (83" x 147")	2100mm x 4730mm (83" x 186")
Voltage	AC220V ± 10%, 50Hz	AC220V ± 10%, 50Hz	AC220V ± 10%, 50Hz	AC220V ± 10%, 50Hz
Consumption	3KW	3KW	3KW	3KW
Engraving Software	Type3	Type3	Type3	Type3
Interface	USB / Ethernet	USB / Ethernet	USB / Ethernet	USB / Ethernet
Type Of Worktable	Aluminum slot	Aluminum slot	Aluminum slot	Aluminum slot
<b>Price</b>	≤ \$7,650	≤ \$9,570	≤ \$11,230	≤ \$13,105

Note: Parameters are subject to change. Use the company technical standards as the basis.

## ▼ Samples

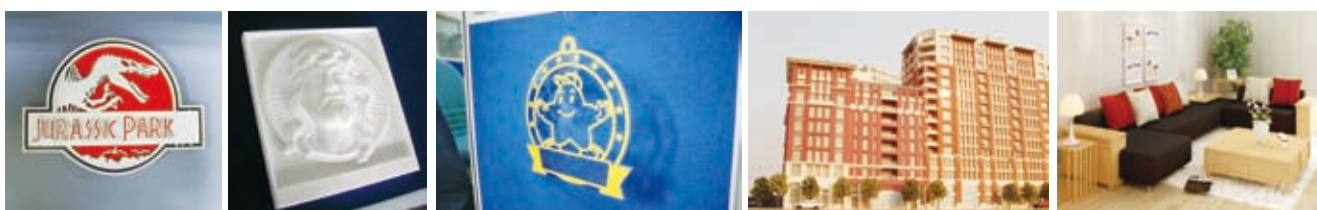

## CNCR-CP-Y-I Series High Precision CNC Router, with 3.7KW Spindle and Vacuum System

## ▼ Main Configuration Information

Maximum Travel Speed: 25000mm (984") / min

Spindle: 3.7KW Chinese air cooled

Vacuum working table, 7.5KW (2m x 4m machine adopts 11KW) vacuum pump, and 3.5KW dust collector

X, Y, Z axis adopt circular guideway, Y axis adopts double bolt pole transmission, Leadshine drivers

3.5" DSC - 931 Color screen controller, double Y axis,

stepper motor



## ▼ Specifications



Model	CNCR-CP-1325Y-I	CNCR-CP-1530Y-I	CNCR-CP-2030Y-I	CNCR-CP-2040Y-I
Precision Repeatability	± 0.05mm	± 0.05mm	± 0.05mm	± 0.05mm
Maximum Engraving Area	1300mm x 2500mm (51" x 98")	1500mm x 3000mm (59" x 118")	2000mm x 3000mm (79" x 118")	2000mm x 4000mm (79" x 157")
Spindle Power	3.7KW Chinese air cooled	3.7KW Chinese air cooled	3.7KW Chinese air cooled	3.7KW Chinese air cooled
Spindle Rate	18000r / min	18000r / min	18000r / min	18000r / min
Cutting Tool Diameter	Φ3.175, Φ4, Φ6, Φ8	Φ3.175, Φ4, Φ6, Φ8	Φ3.175, Φ4, Φ6, Φ8	Φ3.175, Φ4, Φ6, Φ8
Travel of Z Axis	110mm (4.3")	110mm (4.3")	110mm (4.3")	110mm (4.3")
Maximum Movement Speed	25000mm (984") / min	25000mm (984") / min	25000mm (984") / min	25000mm (984") / min
Working Table Size (X, Y)	1360mm x 3030mm (53.5" x 119")	1600mm x 3730mm (63" x 147")	2100mm x 3730mm (83" x 147")	2100mm x 4730mm (83" x 186")
Voltage	AC220V ± 10%, 50Hz	AC220V ± 10%, 50Hz	AC220V ± 10%, 50Hz	AC220V ± 10%, 50Hz
Consumption	4.5KW	4.5KW	4.5KW	4.5KW
Engraving Software	Type3	Type3	Type3	Type3
Interface	USB / Ethernet	USB / Ethernet	USB / Ethernet	USB / Ethernet
Type Of Worktable	Vacuum	Vacuum	Vacuum	Vacuum
<b>Price</b>	≤ \$11,800	≤ \$13,300	≤ \$15,490	≤ \$19,670

## CNCR-CP-Y-II Series High Precision CNC Engraver, with 4.5KW Italy Spindle and Vacuum System

### ▼ Main Configuration Information

**Maximum Travel Speed:** 25000mm (984") / min  
**Spindle:** 4.5KW Italy air cooled  
 Vacuum working table, 7.5KW (2m x 4m machine adopts 11KW) vacuum pump, and 3.5KW dust collector  
 X, Y, Z axis adopt circular guideway, Y axis adopts double bolt pole transmission, Leadshine drivers  
 3.5" DSC - 931 Color screen controller, double Y axis, stepper motor

### ▼ Samples

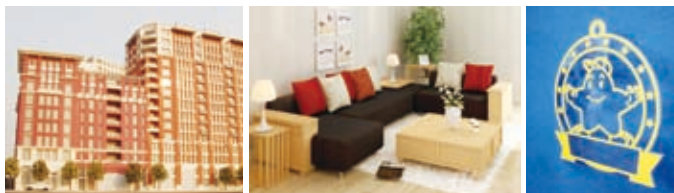

### ▼ Specifications

Model	CNCR-CP-1325Y-II	CNCR-CP-1530Y-II	CNCR-CP-2030Y-II	CNCR-CP-2040Y-II
Precision Repeatability	± 0.05mm	± 0.05mm	± 0.05mm	± 0.05mm
Maximum Engraving Area	1300mm x 2500mm (51" x 98")	1500mm x 3000mm (59" x 118")	2000mm x 3000mm (79" x 118")	2000mm x 4000mm (79" x 157")
Spindle Power	4.5KW Italy air cooled	4.5KW Italy air cooled	4.5KW Italy air cooled	4.5KW Italy air cooled
Spindle Rate	18000r / min	18000r / min	18000r / min	18000r / min
Cutting Tool Diameter	Φ3.175, Φ4, Φ6, Φ8	Φ3.175, Φ4, Φ6, Φ8	Φ3.175, Φ4, Φ6, Φ8	Φ3.175, Φ4, Φ6, Φ8
Travel of Z Axis	110mm (4.3")	110mm (4.3")	110mm (4.3")	110mm (4.3")
Maximum Movement Speed	25000mm (984") / min	25000mm (984") / min	25000mm (984") / min	25000mm (984") / min
Working Table Size (X, Y)	1360mm x 3030mm (53.5" x 119")	1600mm x 3730mm (63" x 147")	2100mm x 3730mm (83" x 147")	2100mm x 4730mm (83" x 186")
Voltage	AC380V ± 10%, 50Hz	AC380V ± 10%, 50Hz	AC380V ± 10%, 50Hz	AC380V ± 10%, 50Hz
Consumption	5.3KW	5.3KW	5.3KW	5.3KW
Engraving Software	Type3	Type3	Type3	Type3
Interface	USB / Ethernet	USB / Ethernet	USB / Ethernet	USB / Ethernet
Type Of Worktable	Vacuum	Vacuum	Vacuum	Vacuum
<b>Price</b>	≤ \$13,240	≤ \$14,760	≤ \$16,940	≤ \$21,130



## CNCR-LD Series Advertisement CNC Engraver

It is mainly used in advertising signs making, doing 2D and 3D engraving and cutting on non-metal materials and light metal, such as ABS double color plate, acrylic, wood, PVC board, foam board, organic plastics, PCB, brass, aluminum and so on.

### ▼ Main Configuration Information

**Maximum Travel Speed:** 20m / min (DSP)  
**Spindle Power:** 800W / 1.5KW / 2.2KW Chinese water cooling  
**Machine Body:** Aluminum-alloy table + protective table top  
 Welded structure, X, Y, Z directions using bolt pole transmission to ensure the process precision  
 DSP (USB interface), operation with the handle, large screen display, convenient operation and simple maintenance  
 16 pcs engraving tools.  
**Software:** Type3 or UcanCAM V9



CNCR-LD-1318H



### ▼ Specifications

Model	CNCR-LD-9065H	CNCR-LD-1212H	CNCR-LD-1318H	CNCR-LD-1325H
Maximum Engraving Area	900mm x 650mm (35" x 26")	1200mm x 1200mm (47" x 47")	1300mm x 1800mm (51" x 71")	1300mm x 2500mm (51" x 98")
Travel of Z axis	70mm (3")	100mm (4")	100mm (4")	100mm (4")
Spindle Power	800W water cooling	1.5KW water cooling	1.5KW water cooling	2.2KW water cooling
Resolution	0.01mm	0.01mm	0.01mm	0.01mm
Maximum Travel Speed	6m (236") / min	10m (394") / min	10m (394") / min	10m (394") / min
Engraving Tool	Φ3.175, Φ6	Φ3.175, Φ6, Φ4 (optional)	Φ3.175, Φ6, Φ4 (optional)	Φ3.175, Φ6, Φ4 (optional)
Motor	Stepper motor	Stepper motor	Stepper motor	Stepper motor
Machine Dimension	1300mm x 1000mm x 1100mm (51" x 40" x 43")	1600mm x 1400mm x 1400mm (63" x 55" x 55")	2200mm x 1500mm x 1400mm (87" x 59" x 55")	2900mm x 1500mm x 1450mm (114" x 59" x 57")
Machine Weight	180kg	240kg	320kg	600kg
<b>Price</b>	≤ \$3,045	≤ \$3,933	≤ \$4,820	≤ \$5,810



## CNCR-SD-SAI plus Series Heavy Duty Structure Stone / Glass CNC Engraver

This series engraver is mainly used for processing many kinds of hard materials such as marble, granite, glass, floor tiles and soft metals (Aluminum and copper).

### ▼ Main Configuration Information

**Height of Gantry Lift:** 300mm

**Maximum Travel Speed:** 20m / min (NcStudio controlling system)

**Spindle Power:** 5.5KW water cooling

**Machine Body:** One - piece cast Iron, Water cooling circulation system + spray nozzle + front and back of machine with pulley gear and water tank.

**Pulley gear** installed in the front of working table for loading stone easily, it is very convenient for moving stone.

**Water tank** installed at the back of working table for storing water.

X, Y axes adopt helical rack gear wheel transmission, which increase machine's using intensity and service life.

Z axis adopts ball screw transmission ensures the precision in processing.

X, Y, Z axes adopt round rods guide structure, resistant and anticorrosion. High quality fittings make the machine drive smoothly.

NcStudio controlling system

15 pcs engraving tools for stone engraving



Pulley gear



Water Box

### ▼ Specifications

Model	CNCR-SD-9015SAI-Plus	CNCR-SD-1318SAI-Plus	CNCR-SD-1325SAI-Plus
Maximum Engraving Area	900mm x 1500mm (35" x 59")	1300mm x 1800mm (51" x 71")	1300mm x 2500mm (51" x 98")
Spindle Power	5.5KW water cooling	5.5KW water cooling	5.5KW water cooling
Worktable Size	1000mm x 1600mm (59" x 84")	1500mm x 2130mm (59" x 84")	1500mm x 3110mm (59" x 122")
Maximum Carve Height	300mm (11")	300mm (11")	300mm (11")
Maximum Carve Speed	<20m (787") / min	<20m (787") / min	<20m (787") / min
Resolution	0.001mm / Pulse	0.001mm / Pulse	0.001mm / Pulse
Repeat Precision	0.01mm	0.01mm	0.01mm
Rotational of Spindle	2,4000rpm / min	2,4000rpm / min	2,4000rpm / min
Engraving Tool Dia.	8, 6, 4, 3.175mm	8, 6, 4, 3.175mm	8, 6, 4, 3.175mm
Power Supply	AC380V, 50Hz	AC380V, 50Hz	AC380V, 50Hz
Machine Dimension	1950mm x 1050mm x 1550mm (77" x 41" x 61")	1710mm x 2670mm x 1650mm (67" x 105" x 65")	1710mm x 3240mm x 1650mm (67" x 128" x 65")
Machine Weight	750kg	850kg	1100kg
<b>Price</b>	<b>≤ \$10,470</b>	<b>≤ \$11,000</b>	<b>≤ \$11,720</b>

### ▼ Samples



## CNCR-GDWM Series Large Format Woodworking CNC Router

**Max. Engraving Area:** 1300mm x 2500mm (51" x 98"), 1500mm x 3000mm (59" x 118"), 2000mm x 3000mm (79" x 118")

**Travel Speed (X, Y, Z move together):** 50m (1968") / min

**Spindle:** 6KW inverter - driven spindle motor cooled by water

**With vacuum adsorption worktable, vacuum pump and dust collector**

**Steel structure, high power, and high torque drive motor, keep the machine working in high speed. Vacuum adsorption platform, widened gantry, imported high precision helical rack on X, Y, Z axis, It makes the machine has large contact surface, stronger load force and reduce the shake.**

**The unique pneumatic protection device and Taiwan automatic oil lubrication system, effectively reduce the loss between the Z axis screw and nut, be good for buffer, to extend the machine's life.**

X Y and Z axes select imported 25mm (1") linear guide way, z axis by imported ball screw.

Original UcanCam V9 software

### ▼ Typical Application

- Wood processing, furniture spare parts processing
- Abnormity cutting of plate office furniture
- Relief sculpture processing of archaizing woodwork, free - painting door and wooden door processing
- Special drawings processing, flower carving, cupboard doors
- Acrylic plate processing, relief sculpture wooden lines
- Wooden decorative spare parts processing, man-made marble, high density plate cutting



The imported helical rack and pinion



Oil smoothing equipment



### ▼ Specifications

Model	CNCR-GDWM-1325	CNCR-GDWM-1530	CNCR-GDWM-2030
Maximum Engraving Area	1300mm x 2500mm (51" x 98")	1500mm x 3000mm (59" x 118")	2000mm x 3000mm (79" x 118")
Travel of Z axis	180mm (7.1")		
Spindle Power	6kw inverter - driven, cooled by air or water		
Resolution	0.025mm (0.002")		
Maximum Travel Speed	50m (1968") / min		
Engraving Tool	Ø12.7 (φ 3.175 , φ 6, φ 4 (optional))		
Motor	Stepper motor		
CNC Controller	Ncstudio system		
Engraving Software	UcanCAM V9		
Type of Worktable	Vacuum table, four sections		
Vacuum Pump	5.5KW, 400m <sup>3</sup> / H		
Machine Dimension	3050mm x 1800mm x 1680mm (120" x 71" x 66")	3550mm x 2000mm x 1450mm (140" x 79" x 57")	3550mm x 2500mm x 1450mm (140" x 98" x 57")
Machine Weight	1700kg	2000kg	2300kg
<b>CIF Price</b>	≤ \$12,800	≤ \$16,750	≤ \$19,750
<b>Optional Device</b>	Servo system: +\$2,800		

### ▼ Samples



## CNCR-S3 (Typical C) series Woodworking CNC Routers

New appearance, good - stability, high - speed, network, user - friendly, modular structure.

It is specially designed for end - market and suitable for mass processing of all kinds of boards, such as aluminum plate, copper plate, acrylic board, marble board, MDF board, wood plate and so on.

Widely used in the woodworking industry, kitchen cabinet, sign - making, decoration and so on.

**This CNC router is equipped with 3.7KW Chinese air cooled spindle motor, vacuum adsorption worktable, vacuum pump and dust collector.**

### ▼ Main Configuration Information

**Height of Gantry Lift:** 160mm (6.3")

**Maximum Travel Speed:** 20m (787") / min

**Spindle Power:** Chinese water / air cooling 3.7KW

**Resolution:** 0.025mm / Pulse

**Machine Body:** Steel - aluminum mixed

All three axes adopt the imported 25mm (1") linear ball bearing and rack transmitting design. High precision X axis of double motors driving.

Automatic tool calibrator

Ethernet and serial communications interface are available to the host computer system.

VII CNC controller, 12 pcs engraving tools

**Software:** Artcut 2010 multi-language. (Include: English, Germany, France, Japanese, Portuguese, Russian, Spanish, etc.).



- Fast speed: Its speed can reach 20m (787") / min, as much as you buy two or three sets of CNC machine in other brand. It can realize fast processing of embossment and 3D engraving. It can also bear fast processing with high - power spindle on over 50kg heavy workpieces.
- High control precision: Its maximum control precision can reach 0.001mm.
- High precision of Z axis and its travel field is over 160mm (6.3"), which is suitable for making shaped mould and half - finished goods.
- Manufactured in accordance with the structure of industrial machinery design, good steeliness.
- Gantry adopts double motors driving, which makes the whole machine running fast, stable and uniform.
- Using patented split-module structure, easy to transport and transfer the machine into ordinary doors.



### ▼ Samples



### ▼ Specifications

Model	S3406	S3408	S3510	S3710
Maximum Engraving Area	1800mm x 1300mm (71" x 51")	2500mm x 1300mm (98" x 51")	3048mm x 1524mm (120" x 60")	3000mm x 2000mm (118" x 79")
Travel of Z axis	160mm (6.3")			
Spindle Power	3.7KW Chinese Water cooling		3.7KW Chinese Water cooling	
Resolution	0.025mm (0.001")			
Maximum Travel Speed	20m (787") / min			
Engraving Tool Dia.	3.175, 6, 4mm (optional)			
Motor	Step motor			
Controller Cabinet	Artisan VII Controller			
Power Supply	AC380V, 50Hz / 60Hz			
Machine Dimension	2200mm x 2010mm x 1450mm (87" x 79" x 57")	3040mm x 2010mm x 1450mm (119" x 79" x 57")	3450mm x 2210mm x 1380mm (136" x 87" x 54")	3450mm x 2210mm x 1500mm (136" x 87" x 59")
Machine Weight	550kg	650kg	900kg	1000kg
<b>Price</b>	≤ \$13,500	≤ \$15,500	≤ \$20,900	≤ \$22,900



## CNCR-JNR-1325ATC: Woodworking Multifunction CNC Center with Carrousel ATC

Configured with imported tool magazine of 8 tools, the CNC router can change tools speedy and freely.

With Italy combination drills (11 bits + 1 saw blade), the CNC router can finish various processes one time including drilling, edge cutting, slotting, lock hole making and expanding for the wooden door panels with complicated processing requirement.

### ▼ Application

**Architectural Model Industry:** Linear ATC CNC Router is suitable for metal models, gravel, plastic board, PVC board and other non - metal models.

**Woodworking Industry:** 3D wave patterns carved panels, cabinet doors, solid wood doors, wooden craft, non - painting doors, screens, craft window, computer tables and other auxiliary furniture.

**Advertising Industry:** Billboard advertising, sign making, acrylic cutting, mold forming and other advertising processes

**Image engraving, embossing, craft and gift industry**



### ▼ Main Configuration Information

**Engraving area:** 1300mm x 2500mm (51" x 98")

**Height of Gantry Lift:** 230mm (9")

**Max. Travel Speed:** 6m (2362") / min (DSP)

**Spindle Power:** Italy HSD 8KW air cooling

**Rotary Carrousel:** Auto - tool Changer system, Tool magazine capacity of 8 tools, Tool change time only 8 seconds.

Japanese YASKAWA servo motor 850W, which makes the CNC router stably running with low noise, high speed, and high accuracy

**Italy combination drills (11 bits + 1 saw blade).**

Welded structure by thick profiled steel and stabilized under high temperature, which ensure minimum distortion, excellent rigidity and powerful strength.

**Transmission:** X, Y axis high precision Rack Gear, Z axis imported Ball screw.

**X, Y, Z guide rail:** Linear Square Rail.

Automatic lifting device for vacuum suckers

Color LCD display.

Tool sensor enables the machine to compensate the tolerance of tool length.

**Software:** Type3 or Ucamcam V8

### ▼ Samples

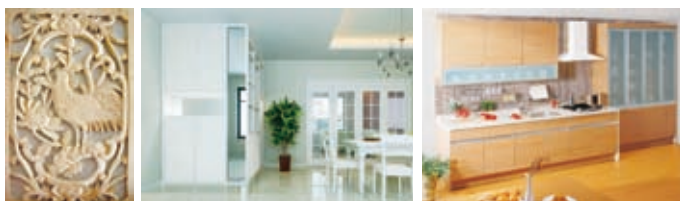

Taiwan Syntech control system



Italy air - cooling ATC spindle



Italy multi - function group drills



Vacuum sucker



Taiwan ATC rotary carrousel



Japan Yaskawa servo motor

### ▼ Specifications

Model	CNCR-JNR-1325ATC
Maximum Engraving Area	1300mm x 2500mm x 230mm (51" x 98" x 9")
Spindle Power	Italy HSD 8.0KW Air Cooling
Maximum Travel Speed (X, Y, Z triaxial move together)	60m / min (2362IPS)
Maximum Engraving Speed	25m / min (984IPS)
Instruction Resolution	0.05 / 300mm
Repeat Precision	0.04mm / 300mm
Engraving Tools Dia.	2 - 20mm
Rotational Speed of Spindle	6000 - 24000rpm
CNC Controller	DSP with USB interface
Type of Driving Motor	Japan servo motor 850W
Type of Worktable	Vacuum
Interface	USB
Power Supply	AC380V, 50Hz
Cooling Method	Air cooling
Machine Dimension	3230mm x 2320mm x 2000mm (127" x 91" x 79")
Machine Weight	2500kg
<b>Price</b>	<b>≤ \$49,300</b>

### CNCR-GDTM-2030SATC CNC Center with Carrousel ATC

With SERVO MOTOR, vacuum system (Vacuum worktable, vacuum pump and dust collector), 9KW air cooled spindle motor, carrousel automatic tool changer



Oil smoothing equipment



The imported helical rack and pinion



Cutting tool



Vacuum pump

#### ▼ Main Equipment

**Max. Engraving Area:** 2000mm x 3000mm (79" x 118")  
**Travel Speed (X, Y, Z triaxial move together):** 60m (2362") / min  
**Spindle:** Italy HSD 9KW air cooled  
**Taiwan LNC. Control system with 8 sets cutters of ISO 30**  
 Entire steel frame structure with 300mm width six of points touch the ground makes the machine steady as a rock. Vacuum adsorption working platform, widened gantry, great size widened guide rail, the Z axis working height is up to 220mm (8.6"). **Imported high precision helical rack on X, Y, Z axes**, It makes the machine has large contact surface, stronger load force and reduce the shake.

Delta inverter important from Taiwan with high quality  
 Taiwan automatic oil lubrication system, pneumatic protection device, full time running and unnecessary maintenance  
 Original UcanCam V9 software

#### ▼ Samples



#### ▼ Specifications

Model	CNCR-GDWM-2030
Maximum Engraving Area	2000mm x 3000mm (79" x 118")
Travel of Z axis	8.6" (220mm)
Z Max feed - in	8" (200mm)
Spindle Power	Italy HSD 9kw cooled by air
Resolution	0.025mm (0.002")
Maximum Travel Speed	60m (2362") / min
Engraving Tool	∅12.7 (∅ 3.175 , ∅6 , ∅4 (optional))
Motor	Servo motor
CNC Controller	Taiwan LNC. system
Engraving Software	UcanCAM V9
Type of Worktable	Vacuum table
Vacuum Pump	7.5KW, 400m <sup>3</sup> / H
Machine Dimension	3500mm x 2300mm x 2250mm (138" x 91" x 89")
Machine Weight	2500kg
<b>Price</b>	<b>≤ \$42,600</b>



## CNCR-WZLD-1616: 5 Axis Processing Center

Our 5 axis processing center is the most advanced machine in the world.



### ▼ Main Configuration Information

18KW, 360 degree Italian HSD spindle motor, air cooling  
 Moving speed: 32m (1260") / min, processing speed: 20m (787") / min  
 Japan YASKAWA AC servo motor  
 Japan SANYO ATC system, Geneva type, 8 bits. It only takes 7 seconds to change a tool, saving labor and time  
 High precision AMT guideway and double rows ball bearing. High bearing capacity, long service life, stable operation  
 X, Y, Z axis all adopt high precision PMI ball screw, making positioning more precise and the quality better  
 Overall casting, through tempering stress removal and twice precision matching to effectively ensure high precision and long service life  
 Automatic air system avoids the spindle inhaling dust  
 Automatic lubrication system makes lubrication centrally  
 Independent automatic calibration system ensures operation precise and flexible  
 FANUC 5 axis control system  
 Compatible with all popular software, such as Type3, Artcam, AlphaCAM, Pro / E, etc

### ▼ Specifications

Model	CNCR-WZLD-1616
Working Area	1600mm x 1600mm x 600mm (63" x 63" x 24")
Table Size	1700mm x 1700mm (67" x 67")
Spindle Power	HSD 18KW air cooling 360 degree
Spindle Rotary Speed	0 - 5000r / min
Mechanical Structure	Casted working table
Transmission	High precision ball screw X, Y, Z axis
Processing accuracy	0.01mm
Repeat Positioning Accuracy	0.02mm
Max. Moving Speed	32m (1260") / min
Max. Working Speed	20m (787") / min
ATC System	Japan SANYO. 8 bits
Drive System	Japan YASKAWA AC servo motor
Control System	Fanuc
Engraving Tool Dia.	3.175, 6, 8, 10, 12.7, 20mm
Power Supply	AC380V, 50Hz
Machine Dimension	3000mm x 4000mm x 2800mm (118" x 157" x 110")
Machine Weight	7000kg
Price	≤ \$175,000

## CNCR-QDS-20122A-10: 10 Heads Cylinder CNC Engraver

10 heads, which can process ten pcs of workpiece together, increasing working efficiency and saving labor  
 Mainly used for European-style Roman column, simulated mahogany furniture and all kinds of cylinders

### ▼ Main Configuration Information

Servo system, PCI digital controlling system, with balance cylinder  
 Machine tools in overall thick wall pipe structure, analyzed and designed by FEA, have difficult deformation and high rigidity  
 Imported linear bearing and ball screw assure process with high speed and high precision  
 Removable working table

### ▼ Specifications

Model	CNCR-QDS-20122A-10
Maximum Engraving Area	1200mm x 200mm (51" x 9.8")
Spindle Power	2.2KW water cooled spindle
Maximum Engraving Speed	10m (394") / min
Instruction Resolution	0.04mm
Repeat Precision	0.01mm / 300mm
Engraving Tools Dia.	3.175mm, 6mm, 12.7mm
Rotational Speed of Spindle	18000rpm
Type of Driving Motor	Servo motor
Power Supply	AC220V (380V), 50Hz
Machine Dimension	2200mm x 2500mm x 1700mm (87" x 98" x 67")
Machine Weight	1100kg
Price	≤ \$34,850



## CNCR-SMART-106: Mini Multi - functional and Low Noise CNC Engraver



"The SMART engraving machine" is ultra - small, quiet and a multipurpose machine. Suitable for gifts, souvenirs, and jewelry stores, it can engrave items like: cigarette lighters, key chains, picture frames, wristwatches and other jewelry items made from gold and silver. No need to change the holding clamps, you can engrave on stone chops, horn chops, copper chops, fountain pens, etc. It can also engrave small name badges and product labels.

**Machine Body:** USA made lead screw, high performance ARM-CNC controller system, large LCD display, USB memory stick and USB communications port. Comes with a high capacity FLASH memory

I set of cutters (8pcs) supplied with each machine. Specialized cutters available for hard materials

- Comes with a high speed spindle and step - less speed regulator. Highest rotational speed is 24,000 revolutions / minute. Small engravings are very easy to accomplish.
- Comes with an USA made lead screw, which is very quiet while operating.
- Suitable for use in offices for initial design work and RP (Rapid prototypes) mobile phones, digital cameras, jewelry, etc.
- Compatible with many different kinds of CAD / CAM software which can produce HPGL or G Code.
- 1 set of cutters (7 pcs) supplied with each machine.
- 12 month warranty for all parts including labor.

### ▼ Specifications



Model	CNCR-SMART-106
Working Table Size	100mm x 100mm (4" x 4")
Maximum Working Size	100mm x 60mm x 35mm (4" x 2" x 1.4")
Spindle Power	40W
Positioning Precision	0.002mm / pulse
Spindle Rate	18000r / min
Maximum Travel Speed	3.6m / min
Engraving Tool Dia.	3.175, 4mm
Driving Motor	Stepper motor
Power Source	AC220V ± 10% 50Hz
Consumption	0.15KW
Machine Dimension	400mm x 530mm x 490mm (16" x 21" x 19")
Machine Weight	30kg
<b>Price</b>	<b>≤ \$3,090</b>

## CNCR-SE3230: High Precise Metal CNC Mould Engraving Machine

It is a CNC engraving machine developed for small moulds and for working on soft metal (Aluminum and copper).

Double column design, imported linear guide and ball screw, 5.7 inch LCD display, USB 2.0 connector and a large internal memory, linear guide, SaiO4 controller, step motor.

I set of cutters (8pcs) supplied with each machine. Specialized cutters available for hard materials.

- The CNC engraving machine is easy to operate and easy to learn. You can choose speed priority or quality priority and it's easy to switch between the two.
- The cutting knife goes in at an angle, instead of in a straight line, for smoother cutting.
- The machine gives a high ratio, price to performance wise, and can be used on a broad range of applications.
- Power - off protective memory function assures resuming the operation from the same place after powering it off.

### ▼ Specifications



Model	CNCR-SE-3230
Working Table Size	380mm x 360mm (15" x 14")
Maximum Working Size	320mm x 300mm x 100mm (12.5" x 12" x 4")
Spindle Power	0.8KW water cooled spindle
Positioning Precision	±0.04 / 300mm
Spindle Rate	24000r / min
Maximum Travel Speed	3m (118") / min
Engraving Tool Dia.	3.175, 4, 6 mm
Driving Motor	Stepper motor
Power Supply	AC220V ± 10%, 50Hz
Consumption	2KW
Machine Dimension	1000mm x 920mm x 1360mm (39" x 36" x 53")
Machine Weight	180kg
<b>Price</b>	<b>≤ \$7,360</b>



### ▼ Samples



## CNCR-MEII-4242S: High Precision Metal CNC Mould & DIE Engraving Machine

The CNC mould engraving machine can very easily satisfy most mould cutting requirements. The hand controller is very easy to operate and allows faster operation. Suitable for mould injections, heat transfer moulds, press moulds, and other copper and EDM moulds.



### ▼ Main Configuration Information

**Max. Travel Speed:** 6m (236") / min (Servo)

**Spindle Power:** 1.5 KW

**Machine Body:** Double column stand, cast iron built, linear guide system. German ball screw, high speed double CPU-CNC control system. 1 set of cutters (7 pcs) supplied with each machine.

- The CNC mould engraver was released in 2005, it uses a double column stand, cast iron built, and linear guide system.
- Equipped with Type3 engraving software. The CNC mould engraver is compatible with different CAD / CAM software, such as Artcam, Casmate, Proe, UG, Artgrave, Ucamcam V8, etc.
- Power - off protective memory function assures restarting work in the same position after power - off.

### ▼ Specifications

Model	CNCR-MEII-4242S
Working Table Size	440mm x 540mm (17" x 21")
Maximum Working Size	420mm x 420mm x 150mm (16.5" x 16.5" x 5.9")
Spindle Power	1.5KW water cooled spindle
Positioning Precision	±0.03 / 300mm
Maximum Spindle Rate	24000r / min
Maximum Travel Speed	3m (step) / 6m (servo) / min
Engraving Tool Diameter	3.175mm, 4mm, 6mm
Driving Motor	Servo motor
Power Source	AC220V ± 10%, 50Hz
Consumption	4.0KW
Optional Device	The fourth axis - rotary fixture
Machine Dimension	1050mm x 1300mm x 1620mm (41" x 51" x 64")
Machine Weight	740kg
<b>Price</b>	<b>≤ \$14,600</b>



### ▼ Samples





## CS-PBCM-DCZ Series Standard Paper Box Sample Cutter

This cutter can achieve the structural design of carton quickly, including folded, tubular and reel types, envelope packing, fixed carton and corrugated carton.

It adopts the technique of vibrating blade cutting to produce any shape and ensure the accuracy of the design sample. It has been an eye - catching product among major packaging enterprises and has also been well - received by them since it was launched. Furthermore, it has been a powerful tool for production display and design strength.

This carton box sample cutter is used in the manufacturing of products such as packing devices, regular and corrugated paper boxes, color prints, color boxes, absorbing plastic folding boxes, foam boards, hard and thin boards and laser tools.

To be used in carton and paper box packing factories. It can cut and crease 15mm (0.59") corrugated paper.



High-quality



Machine head

### ▼ Functions

**Oscillating tool cutting function:** It is able to cut different materials such as corrugated paper, card paper, offset paper, grey board, compound materials, gasket, leather and textiles.

**Folding function:** It can fold corrugated paper, card paper and offset board into a relatively perfect folding line.

**Dotted line function:** It is used to fold corrugated and grey card paper after cutting them in half, and to cut a dotted line.

**Location function:** Precision location with a laser lamp.

**Drawing function:** It can draw various high precision drawings.

### ▼ Samples



**The tool head has 3 tool holders: A pen, a creasing wheel, an oscillating knife**



**Pen:** It can realize the drawing function, draw different type high precision picture



**Vibration knife cutting function:** it can cut corrugated paper, cardboard paper, glue paper, grey paper, laminated paper, etc.



**Creasing Wheel:** Press fold line function, it can press perfect line in the corrugated paper, cardboard, grey board etc.

### ▼ Specifications (Custom making of other size of tables is also available.)



Model	CS-PBCM-DCZ-1310	CS-PBCM-DCZ-1713	CS-PBCM-DCZ-2516	CS-PBCM-DCZ-3016
Maximum Cutting Area	1300mm x 1000mm (51" x 39")	1700mm x 1300mm (67" x 51")	2500mm x 1600mm (98" x 63")	3000mm x 1600mm (118" x 63")
Maximum Cutting Speed	1000mm (39") / s			
Minimum Cutting Diameter	6mm (0.24")			
Maximum Cutting Thickness	15mm (0.59")			
Control Line and Driver	Servo			
Positioning Precision	0.1mm (0.004")			
Repeat Precision	≤0.1mm (0.004")			
Instruction Format	HPGL			
Fixed Type	Vacuum absorption			
Power Support	AC220V ± 10%, 50Hz			
Software	SICCUT processing software. It supports all software that can output files of DXF, PLT format.			
Standard Equipment	Computer, vacuum pump, controlling software, 30 pcs of oscillating blades, and other accessories.			
Optional Device	Kasemake software			
Machine Dimension	1970mm x 1866mm x 1260mm (78" x 73" x 50")	2370mm x 2190mm x 1260mm (93" x 86" x 50")	3170mm x 2475mm x 1260mm (125" x 97" x 50")	3670mm x 2470mm x 1260mm (145" x 97" x 50")
Machine Weight	530kg	765kg	915kg	965kg
<b>Price</b>	≤ \$22,727	≤ \$24,793	≤ \$27,892	≤ \$33,057

## CS-DCZ503020: Digital Finishing Systems for Signs and Displays

### DIE - less Cutting and Creasing Tables

#### Carton box samples making, short - run production of cutting and creasing tables

*Certificate: ISO2000, CE certificate*

This machine makes cutting, creasing, drawing available, stable, high speed, high accuracy. It could meet sample making or small production require of packaging company, corrugated box manufacturer, color box manufacturer, color printing manufacturer, die cutting manufacturer. It could cut corrugated board, chipboard, foam board, plastic board, thin wood board, leather, cloth etc. We are great reputed by customers from packaging, advertisement, printing, die cutting, electron, gasket, sign industries.

The industry's cost - effective digital finishing machine for sign and displays provides automation; high productivity and outstanding precision, loaded with unique features that save time and boost productivity.



### ▼ Specifications

Maximum Cutting Area	3000mm x 2000mm (118" x 79")
Maximum Cutting Speed	39" (1000mm) / s
Minimum Cutting Diameter	0.24" (6mm)
Maximum Cutting Thickness	0.59" (15mm)
Control Line and Driver	Servo motor
Input Cushion Area	32MB
Positioning Precision	0.004" (0.1mm)
Cutting Precision	0.004" (0.1mm)
Repeat Precision	≤0.004" (0.1mm)
Instruction Format	HPGL
Data Port	PCI port
Power Support	AC220V ± 10%, 50Hz
Software	SICCUT processing software. It supports all software that can output files of DXF, PLT format, such as CAD, CorelDraw and AI, etc.
Standard Equipment	Computer, vacuum pump, controlling software, 30 pcs of oscillating blades, and other accessories.
Optional Device	Kasemake software, Video registration system (CCD camera)
Machine Dimension	3720mm x 2470mm x 280mm (146" x 97" x 11") (Machine body)
Machine Weight	420kg (Machine body)
<b>Price</b>	≤ \$54,550



**The tool head has 4 tool holders: a pen, a creasing wheel, an oscillating knife, a drag knife + one holder for CCD camera (Option)**



**Pen:** It can realize the drawing function, draw different type high precision picture



**Vibration knife:** it can cut corrugated paper, cardboard paper, glue paper, grey paper, laminated paper, etc.



**Pressure wheel:** Press fold line function, it can press perfect line in the corrugated paper, cardboard, grey board etc.



**Drag knife tool:** It extends the cutting application to cope with hard, thick materials, which are not available in oscillating cutting tool.

### ▼ Samples



PVC foam board cutting



Plastic corrugated cutting



Rubber cutting



Stand display

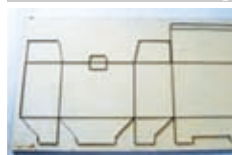

Gray cardboard



Corrugated paper cutting



PVC board cutting

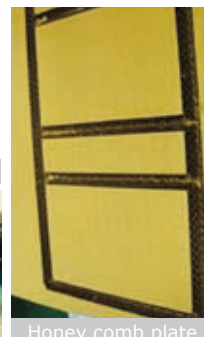

Honey comb plate V-shape cutting



Package box cutting (cardboard)

## CNCR-WJSQ Series Water jet Cutter

Our Water jet Machine is UHP CNC water jet machine with complete functions and it's independently innovated by our team based on the introduced American advanced technologies.

This series of water jet cutting machines have applied in different fields, such as: aviation, weapons, and sophisticated military affairs. It is also widely used in glass, machinery, stone tech, advertising, automotive. Specially designed for materials that cannot be cut by using heat.

**Maximum cutting thickness: Can cut almost any non - metal or metal materials, except tempered glass.**

Aluminum: 150mm (6"), glass: 120mm (5"), steel plate: 100mm (4"), stainless steel: 80mm (3").

### ▼ Main Standard Equipments

- √ a High pressure pump
- √ a CNC machine tool
- √ a cutting table
- √ an automatic abrasive delivery system
- √ a CNC controller cabinet
- √ a cutting head

- Water jet cutters work well in non - conductive and conductive materials.
- Water jet machines cut five to ten times faster than EDM, when the media thickness is less than 1".
- High light 8 LCD display. Feeding rate can achieve adjustment of magnification at any time.
- Via COM, USB interface and PC or U disk for interface directly.
- The servo drive we select YASKAWA of Japan, and the ball screw and guidway we select ABBA or HIWIN of Taiwan, and the PLC controller we select SIEMES of Germany.
- We provide a lifetime guarantee for our machine.
- Power supply for the system and its controller cabinet, can be manufactured according to the customer's needs, as long as it 3 phase.

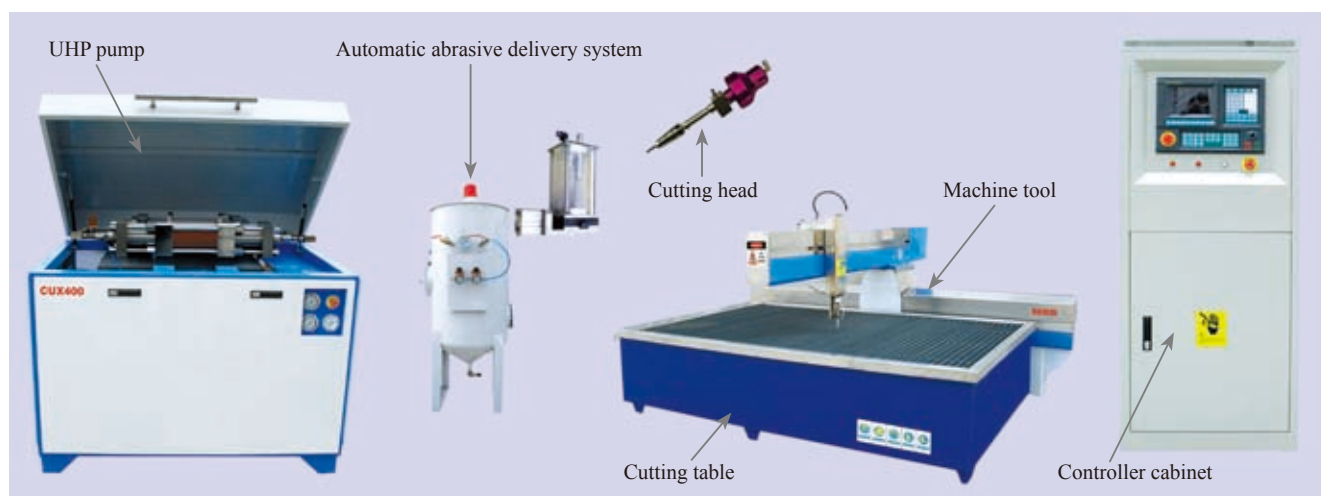

### ▼ Specifications



Model	CNCR-WJSQ1313	CNCR-WJSQ2515	CNCR-WJSQ3020	CNCR-WJSQ4020
Scope of Cutting	1300mm x 1300mm (51" x 51")	2500mm x 1500mm (98" x 59")	3000mm x 2000mm (118" x 79")	4000mm x 2000mm (157" x 79")
Table Dimension	1800mm x 1600mm (71" x 63")	3000mm x 1900mm (118" x 75")	3500mm x 2300mm (138" x 95")	4500mm x 2300mm (177" x 95")
Form of Machine	Cantilever style			
Running Speed	0 - 10m (394") / min			
Control System	AC servo system			
Control Accuracy	+ / -0.002mm			
Cutting Accuracy	+ / -0.1mm			
Maximum Pressure	400Mpa (6000psi)			
Motor Power	30KW			
<b>Price</b>	≤ \$44,214	≤ \$53,730	≤ \$59,200	≤ \$65,200

### ▼ Samples



Glass cutting

Metal cutting

PVC cutting

Steel plate cutting

PVC cutting

Ceramic cutting

Stainless steel cutting

## CNCR-PM1412: CNC Specialized Foam / Plastic Cutter

The foam cutting machine is a new machine in its field, and it can be used for advertising, billboards and the cast iron industry to replace wooden moulds.

The foam/plastics cutter is a hot filament cutter, characterized by its optimized design, large processing scope, and simple operation. It uses 0.5 millimeter heating wire, which allows faster heat release. It is very steady, fast, and has a high degree of fineness. By using an advanced computer design, instead of manually cutting, you now have automated computer controlled cutting, resulting in a much higher efficiency.

- The cutter uses a hot filament for cutting foam and plastics with fashionable design, and a large working table of 1850mm x 600mm (73" x 23").
- By using the 0.5mm heating wire as a cutter, the foam cutter can smoothly and efficiently cut complex shapes.
- Large LCD screen, large working area of 55" x 47" x 19" (1400mm x 1200mm x 500mm), and easy operation.
- You can also choose rotary fixture to process cylindrical objects.

### ▼ Specifications

Product Model	CNCR-PM-1412
Working Table Size	1850mm x 600mm (73" x 23")
Maximum Cutting Size	1400mm x 1200mm x 500mm (55" x 47" x 19")
Maximum Cutting Speed	1200mm / min (48IPS)
Wire Diameter	Ø 0.5mm
Power Source	AC220V ± 10% 50Hz
Driver	Stepper
Consumption	0.8KW
Manner of Receiving Data	Flash memory disk
Optional Device	Rotary fixture
Machine Dimension	1960mm x 1000mm x 1660mm (77" x 39" x 65")
Machine Weight	80kg
<b>Price</b>	≤ \$4,850



The foam cutter with a rotating device (Option) →

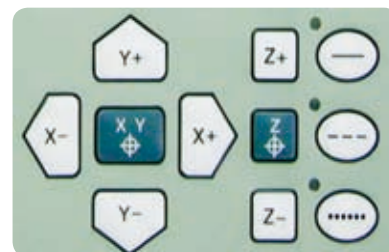

Control panel

### ▼ Samples



> Engraving & Cutting Machine > CNC cutter

### CALCA-IEC-SC Serials High Speed Large Format CNC Cutter System

Developed to cut single - ply and few - ply materials independently, it adopts advanced control system, which is with high cutting speed, high precision, and strong stability. The system is easy to operate; it can cut some soft materials, such as carton fiber, glass fiber, PVC, ETFE, PTFE, HYPALON, oxford cloth, leather automatically with high speed (Without making sampling, drawing line and cutting dies). Aviation, Automobile, Marine, Energy-Saving Wind Power, Leather, Sports, Membranes, Tents, and Garments industries. Different knives configuration, it can fulfill various functions, such as cutting, punching, notching and marks. The arbitrary origin positioning function  
 Fault detection and diagnosis  
 Pneumatic cutting, high speed, high precision  
 Sub - desktop absorption, strong vacuum, adsorbing power  
 Right light positioning function, it can preview the cutting area easily.

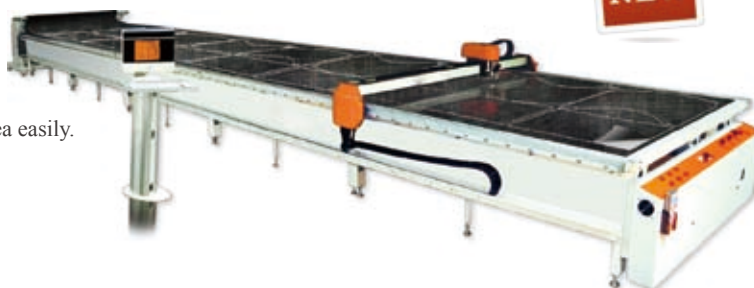

▼ Tool

The system is equipped with variety of cutting tools and pens, which can be moved flexibly and quickly, and cut many materials in different industries; we will select the suitable configuration according to the customer's requirements.

**Rotary knives** (18mm, 28mm, 45mm, etc)  
**Notch knife, tangent knife**

**Punching tools** (5mm, 8mm, 12mm, etc)  
**Pen holder**

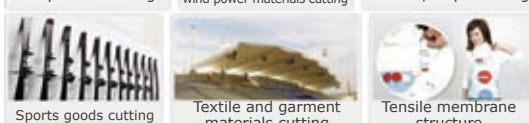
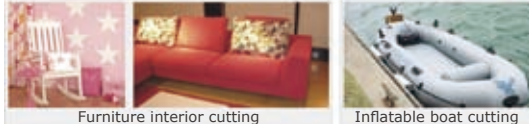
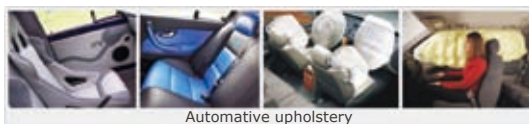

▼ Specifications

Model	Calca-IEC-SC380700	Calca-IEC-SC310700
Maximum Cutting Width	3800mm (149.6") (Maximum width can be made up to 5m)	3100mm (122") (Maximum width can be made up to 5m)
Maximum Cutting Length	7000mm (275.6") (Maximum length can be made up to 50m)	7000mm (275.6") (Maximum length can be made up to 50m)
Maximum Cutting Speed	1800mm (70.9") / s	1800mm (70.9") / s
Acceleration	1g	1g
Cutting Tools	Five, Optional	Five, Optional
Cutting Accuracy	0.2mm (0.008")	0.2mm (0.008")
Maximum Cutting Thickness	8mm (0.3")	8mm (0.3")
Data Format	DXF, HPGL	DXF, HPGL
Interface	Internet, USB	Internet, USB
Driver	Servo motor	Servo motor
Table Media	Vacuum system	Vacuum system
Power	220V, 50Hz or 380V, 50Hz	220V, 50Hz or 380V, 50Hz
Operating Environment	Temperature 0°C - 40°C Humidity 20% - 80%RH	Temperature 0°C - 40°C Humidity 20% - 80%RH
Machine dimension	172" x 319" x 35" (4370mm x 8100mm x 880mm)	144" x 319" x 35" (3670mm x 8100mm x 880mm)
Machine weight	2178lb (990kg)	1958lb (890kg)
<b>Price</b>	<b>≤ \$68,300</b>	<b>≤ \$103,760</b>

## > Vinyl Cutter

**Vinyl Cutter** (Also named cutting plotter) is a common device in the advertising industry, generally speaking, the vinyl cutter is a device which needs to be connected with the computer, receives the commands from the computer and be controlled by the computer. It can make your work easier and faster for making any kinds of designs.

It can cut sticker and decal vinyl, masking film for painting or etching, vinyl lettering, decorative scrapbooking papers, card stock, stencils, magnetic sheet, sticker's signage, glass sign decals, penaflex as well as all kinds of T - shirt heat transfer media like flex, flock, Magi Cut colored paper for garments and so on.

### CPM-CUTOK DIY Series A3 / A4 Desktop Vinyl Cutter

The desktop vinyl cutter can be used to make stickers, paper crafts, scrapbooks, jigsaw puzzles, DIY, 3D card modeling, cards, letters, gift boxes, etc. It is especially suitable for thick paper cutting; it is the best choice for store, office, school and home use.

Red optic sensor, register marks with contour cutting support, cut plug-in for Corel DRAW. Steel sting feed rollers, leading shaft, high torque motor and micro - step driver locating system. You can draw, cut, kiss - cut and decouple shapes around. You can cut cartoon or other Vinyl and polyester sheets for your business and hobbies.

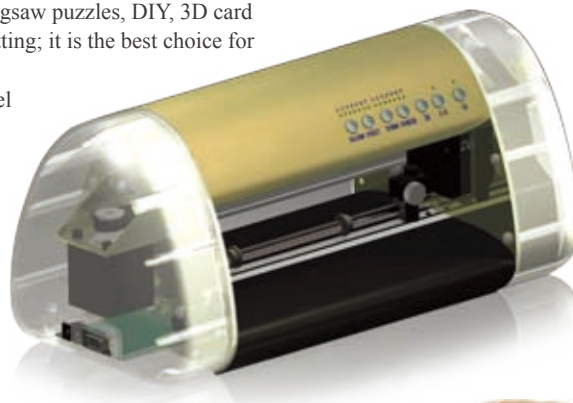

#### ▼ Media Types

Film media 0.1 mm thick or less

Kent paper (inkjet or laser paper up to 300gsm)

Drawing paper, postcards, scrapbook paper

Inkjet photo paper (not all kind of media can be cut)

- CPM-CUTOK-A3 vinyl cutter is a small cutting and drawing plotter with a registration mark laser. It has an innovating design that saves more room.
- High moving precision grit - rolling guaranteed. Optical function - for easier and accurate operation.
- The vinyl cutting plotter can draw, cut and kiss - cut shapes around of cardboard, vinyl and polyester sheets for several uses.
- You can change the cutting - knife into ball pen, then it works as plotting instrument.
- The cutting plotter is powered by a 16V DC adaptor.
- Compatible with Windows VISTA, XP, 2003, 2000, 2007, Mac system. USB interface which support offline working.
- The vinyl cutter is equipped with the CUTOK Master software, especially designed for this machine, which is practical and easy to use. Its main function is contour cutting; it means that you can cut printed graphics along the contour.
- A Windows driver is provided and enables output from leading drawing software (e.g. CorelDRAW 12, Adobe Illustrator CS).

#### ▼ Specifications

Model	CPM-CUTOK-A3	CPM-CUTOK-A4
Driver	Stepper motor	Stepper motor
Maximum Paper Feed Width	298mm (12")	210mm (9")
Maximum Cutting Width	290mm (12")	190mm (7.5")
Maximum Cutting Speed	10-280mm / s ( 7 levels selectable)	
Maximum Cutting Length	2000mm (79")	
Knife Press	60g to 500g (7 levels selectable)	
Minimum Size of Cutting Letter	5mm (0.2")	
Repeat Precision	0.025mm / step 1016DPI or 0.0254mm / step 1000DPI	
Interface	USB2.0	
RAM	256M	
Real Cutter Softball	Yes	
Optical Function	Yes	
Emergency Stop	No	
Power Supply	Dedicated adapter, Outputs: DC 16V 2.5A. Input: AC100V ~ 240V, 47Hz ~ 66Hz	
Machine Dimension	470mm x 170mm x 165mm (18" x 7" x 7")	380mm x 170mm x 165mm (15" x 7" x 7")
Machine Weight	10kg	6kg
<b>Price</b>	≤ \$265	≤ \$210



#### ▼ Samples

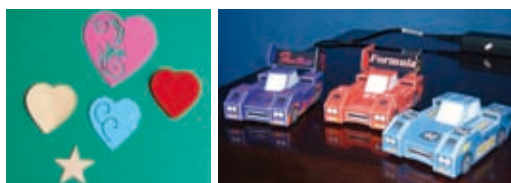
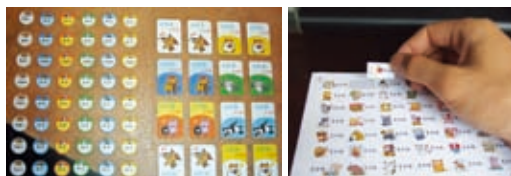

## &gt; Vinyl Cutter

**CPM-RS-C Series Vinyl Cutter with Contour Cutting Function**

Red optic sensor, register marks with contour cutting support, cut plug-in for CorelDRAW. With such a fast, accurate and versatile vinyl cutter plotter, you can contour cut most media pre - printed - from your choice of inkjet, solvent based and laser printer.

**WinPCSign plotting software (Match training CD)**

**Support CorelDraw output directly (But you need to buy a soft dog)**

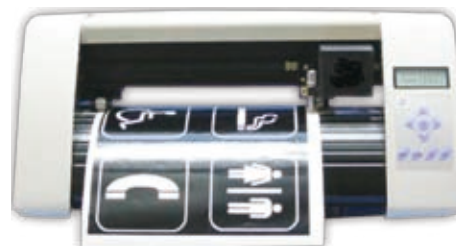

- Low cost and high performance machine for the manufacture of signaling.
- Controlled by RISC high - speed processor, a high speed cache.
- Unique soft impact cutter for smooth cutting.
- It can regulate the pressure and speed numerically at real - time, which is very convenient and can be achieved fast.
- It has a perfect output: There's no saw tooth even when using high speed.
- It supports direct cut - outs from CorelDraw 11, 12, X3, X4, X5, bringing great convenience to work.
- It has a stylish design and very solid support. It doesn't shake while cutting.
- The cutting plotter has LCD with a very accurate and simple English Menu, operated it by pressing buttons.
- The plotter's pinch rollers are adjustable, so the paper stays in place when using rolls of media.

**▼ Specifications (Desktop type)**

Model	CPM-RS-360C	CPM-RS-450C	CPM-RS-500C
Driver	Stepper motor	Stepper motor	Stepper motor
Maximum Paper Feed Width	360mm (14")	450mm (18")	500mm (20")
Maximum Cutting Width	260mm (10")	350mm (13.8")	400mm (15.8")
Maximum Cutting Speed	600mm (23") / s	600mm (23") / s	600mm (23") / s
Maximum Cutting Length	2000mm (79")	2000mm (79")	2000mm (79")
Knife Press	10 - 500g	10 - 500g	10 - 500g
Minimum Size of Cutting Letter	3mm (0.1")	3mm (0.1")	3mm (0.1")
Repeat Precision	0.01mm (0.0004")	0.01mm (0.0004")	0.01mm (0.0004")
Interface	USB2.0	USB2.0	USB2.0
RAM	4M	4M	4M
Real Cutter Softball	Yes	Yes	Yes
Optical Function	Yes	Yes	Yes
Emergency Stop	Yes	Yes	Yes
Power Supply	AC90V - AC230V, 50Hz - 60Hz	AC90V - AC230V, 50Hz - 60Hz	AC90V - AC230V, 50Hz - 60Hz
Machine Dimension	520mm x 240mm x 220mm (20" x 9" x 8")	610mm x 240mm x 220mm (24" x 9" x 8")	660mm x 240mm x 220mm (26" x 9" x 8")
Machine Weight	8kg	9kg	11kg
<b>Price</b>	<b>≤ \$357</b>	<b>≤ \$374</b>	<b>≤ \$416</b>

**▼ Specifications (Stand type)**

Model	CPM-RS-720C	CPM-RS-800C	CPM-RS-1120C	CPM-RS-1360C
Driver	Stepper motor	Stepper motor	Stepper motor	Stepper motor
Maximum Paper Feed Width	720mm (28")	800mm (31")	1120mm (44")	1360mm (53")
Maximum Cutting Width	630mm (25")	700mm (27")	1000mm (39")	1200mm (47")
Maximum Cutting Speed	600mm (23") / s	600mm (23") / s	600mm (23") / s	600mm (23") / s
Maximum Cutting Length	2000mm (79")	2000mm (79")	2000mm (79")	2000mm (79")
Knife Press	10 - 500g	10 - 500g	10 - 500g	10 - 500g
Minimum Size of Cutting Letter	3mm (0.1")	3mm (0.1")	3mm (0.1")	3mm (0.1")
Repeat Precision	0.01mm (0.0004")	0.01mm (0.0004")	0.01mm (0.0004")	0.01mm (0.0004")
Interface	USB2.0	USB2.0	USB2.0	USB2.0
RAM	4M	4M	4M	4M
Real Cutter Softball	Yes	Yes	Yes	Yes
Optical Function	Yes	Yes	Yes	Yes
Emergency Stop	Yes	Yes	Yes	Yes
Power Supply	AC90V - AC230V, 50Hz - 60Hz	AC90V - AC230V, 50Hz - 60Hz	AC90V - AC230V, 50Hz - 60Hz	AC90V - AC230V, 50Hz - 60Hz
Machine Dimension	1020mm x 310mm x 390mm (40" x 12" x 15")	1120mm x 310mm x 390mm (44" x 12" x 15")	1440mm x 310mm x 390mm (56" x 12" x 15")	1700mm x 330mm x 410mm (67" x 12" x 15")
Machine Weight	17kg	19kg	23kg	28kg
<b>Price</b>	<b>≤ \$456</b>	<b>≤ \$505</b>	<b>≤ \$541</b>	<b>≤ \$576</b>



## &gt; Vinyl Cutter

**CPM-FS-C Series Vinyl Cutter Plotter Compatible with Mac System**

With optical sensor that allows contour cut, compatible with Mac System, cut plug - in for CorelDRAW. Steel sting feed rollers, leading shaft, high torque motor and micro - step driver locating system, and one year warranty is provided.

**▼ Standard Accessories**

- 1) Flexisign 8.5 Plotting Software
- 2) User Manual (CD), CorelDraw driver (CD)
- 3) 1 RS232 serial cable
- 4) 1 USB cable
- 5) 1 power cable
- 6) 3 Cutting Blades
- 7) 1 Blade Holder
- 8) 1 Pen Holder
- 9) 1 Deluxe Aluminum Stand

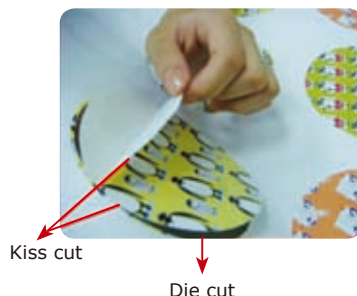
**▼ Specifications**

Model	CPM-FS-C24	CPM-FS-C48
Support Mode	Desktop	Floor stand
Maximum Media Width	720mm (28")	1300mm (51")
Maximum Cutting Width	610mm (24")	1200mm (48")
Operating System	Windows 2000 / XP / 2003 / win7 / 2003 x32 / win7 x64 / Mac OSX10.2.8 & above version	
Interface	RS232C, USB	
Control Panel	10 Silica gel buttons	
Driver	Digital DC, Step Motor, Micro - step Driver	
Display	4 x 8 High Resolution LCD	
Drawing Instruction	HP-GL, DMPL	
Maximum Cutting Speed	23.6" / s (600mm / s)	
Maximum Cutting Thickness	0.04" (1mm)	
Knife Pressure	50g ~ 800g, Level 160 digital control	
Mechanical Precision	0.025mm (0.001")	
Repeat Accuracy	< ±0.1mm (0.004")	
Power Supply	AC90 ~ 240V / 50Hz ~ 60Hz	
Positioning Mode	Bounded System, Random Original Point Setting	
Operating Environment	Temperature: +5°C - 35°C, Relative Humidity: 30% - 70%	
Machine Dimension	890mm x 265mm x 270mm (35" x 10" x 11")	1530mm x 265mm x 270mm (60" x 11" x 11")
Net Weight	12kg	32kg
<b>Price</b>	<b>≤ \$460</b>	<b>≤ \$665</b>



Adopts high - precision steel axes, can prevent slipping while cutting long materials



10 silica gel buttons, easy - to - use and durable



High Speed Arithmetic Microprocessor, stable processing, low noise operation yet without zigzag while cutting



Support Windows 2000 / XP2 / Vista 32 bits system / Mac system



Ultra pressure, capable of punching thick engineering materials



4 x 8 high resolution LCD back light display, suitable for different work surroundings



User - friendly Design, allows to adjust cutting force and working speed while



USB interface to connection computer also support hot - plug

**▼ Samples**



## &gt; Vinyl Cutter

**CPM-LD-H Series Standard Vinyl Cutter**

This series cutting plotter can be used to cut all kinds of pictures, letters on self - adhesive vinyl, sticker.

**With Artcut plotting software**

**Support CorelDraw output directly**

Up to 600mm (24") / s cutting speed

Up to 400g cutting force



- Streamlined design, with a luxurious and modern appearance.
- Steel sting roller made with Japanese technology which guarantees motion precision.
- Single - key operation that regulates force and speed independently.
- Large screen LCD and function keys settled, and USB interface.
- Our factory owns the R&D right of this cutting plotter.
- Standard HPGL language format, more compatibility and direct communication with CORELDRAW.

## ▼ Specifications

Model	CPM-LD-620H	CPM-LD-750H	CPM-LD-1000H	CPM-LD-1250H
Driver	Stepper motor	Stepper motor	Stepper motor	Stepper motor
Maximum Paper Feed Width	720mm (28")	850mm (33")	1100mm (43")	1350mm (53")
Maximum Cutting Width	620mm (24")	750mm (29")	1000mm (39")	1250mm (49")
Maximum Cutting Speed	20 - 400mm (0.8" - 24") / s	20 - 400mm (0.8" - 24") / s	20 - 400mm (0.8" - 24") / s	20 - 400mm (0.8" - 24") / s
Maximum Cutting Thickness	1mm (0.04")	1mm (0.04")	1mm (0.04")	1mm (0.04")
Knife Press	0 - 500g (Digital adjustment)	0 - 500g (Digital adjustment)	0 - 500g (Digital adjustment)	0 - 500g (Digital adjustment)
Repeat Precision	±0.1mm (0.004")	±0.1mm (0.004")	±0.1mm (0.004")	±0.1mm (0.004")
Interface	COM, USB	COM, USB	COM, USB	COM, USB
RAM	128K - 2M	128K - 2M	128K - 2M	128K - 2M
Real Cutter Softball	Yes	Yes	Yes	Yes
Emergency Stop	Yes	Yes	Yes	Yes
Power Supply	AC90V - AC240V, 50Hz - 60Hz	AC90V - AC240V, 50Hz - 60Hz	AC90V - AC240V, 50Hz - 60Hz	AC90V - AC240V, 50Hz - 60Hz
Machine Dimension	920mm x 260mm x 250mm (36" x 10" x 10")	1070mm x 260mm x 250mm (42" x 10" x 10")	1320mm x 260mm x 250mm (52" x 10" x 10")	1560mm x 260mm x 250mm (61" x 10" x 10")
Machine Weight	15kg	22kg	25kg	27kg
<b>Price</b>	<b>≤ \$290</b>	<b>≤ \$392</b>	<b>≤ \$433</b>	<b>≤ \$475</b>

**CPM-LD-1250HS: Vinyl Cutter with Outline Cutting Function**

Advanced optic sensor, automatic 4 - point tracking system to check the location points, continuous contour cutting with high resolution.

**With our own contour cutting technology, Artcut plotting software**

**Support CorelDraw output directly (with CorelDraw Driver)**

Up to 32IPS (800mm / s) cutting speed

Up to 1mm cutting thickness

## ▼ Specifications

Model	CPM-LD-1250HS
Driver	Stepper motor
Maximum Media Width	1350mm (53")
Maximum Cutting Width	1250mm (49")
Maximum Cutting Speed	800mm (32") / s
Maximum Cutting Thickness	1mm (0.04")
Knife Press	0 - 500g (Digital adjustment)
Repeat Precision	±0.1mm(0.004")
Interface	USB
RAM	128K - 2M
Real Cutter Softball	Yes
Emergency Stop	Yes
Power Supply	AC110V / 220V, 50Hz
Machine Dimension	1560mm x 260mm x 250mm (61" x 10" x 10")
Machine Weight	33kg
<b>Price</b>	<b>≤ \$1,075</b>



- Diamond Grade streamlined design, with a luxurious and modern appearance.
- Steel sting roller made with Japanese technology which guarantees motion precision.
- Self - owned intellectual rights so it is easy to maintain and update.
- Single - key operation, to regulate force and speed independently.
- Professional controlling system allows high precision speed and super - speed shares.
- Large LCD.
- Low noise.

## &gt; Vinyl Cutter

**CPM-LD-DS Series High - precision and High - speed Vinyl Cutter**

Updated from CPM-LD-H model

**With Artcut plotting software, Support CorelDraw output directly**

Up to 800mm (31.5") / s cutting speed

Up to 500g cutting force

**▼ Product Highlights**

- It has all features of CPM-LD-H model, but its equipment is higher, Maximum Cutting speed is more fast.
- Streamlined design, with a luxurious and modern appearance.
- Steel sting roller made with Japanese technology which guarantees motion precision.
- The cutting speed of an average cutting plotter is usually 16IPS (400mm / s), but this cutting plotter's maximum cutting speed is up to 32IPS (800mm / s).
- Independence intelligence property rights upgrade and maintain conveniently
- High performance and stability achieved by three CPU for controlling and regulating the power supply.

**▼ Specifications**

Model	CPM-LD-620DS	CPM-LD-750DS	CPM-LD-1000DS	CPM-LD-1250DS
Driver	Stepper motor	Stepper motor	Stepper motor	Stepper motor
Maximum Media Width	720mm (28")	850mm (34")	1100mm (43")	1350mm (53")
Maximum Cutting Width	620mm (24")	750mm (30")	1000mm (39")	1250mm (49")
Maximum Cutting Speed	800mm / s (32")	800mm / s (32")	800mm / s (32")	800mm / s (32")
Maximum Cutting Thickness	1mm (0.04")	1mm (0.04")	1mm (0.04")	1mm (0.04")
Knife Press	0 - 500g (Digital adjustment)	0 - 500g (Digital adjustment)	0 - 500g (Digital adjustment)	0 - 500g (Digital adjustment)
Repeat Precision	±0.1mm (0.004")	±0.1mm (0.004")	±0.1mm (0.004")	±0.1mm (0.004")
Interface	COM, USB2.0	COM, USB2.0	COM, USB2.0	COM, USB2.0
RAM	128K - 2M	128K - 2M	128K - 2M	128K - 2M
Real Cutter Softball	Yes	Yes	Yes	Yes
Emergency Stop	Yes	Yes	Yes	Yes
Power Supply	AC90V - AC240V, 50Hz - 60Hz	AC90V - AC240V, 50Hz - 60Hz	AC90V - AC240V, 50Hz - 60Hz	AC90V - AC240V, 50Hz - 60Hz
Machine Dimension	920mm x 260mm x 250mm (36" x 10" x 10")	1070mm x 260mm x 250mm (42" x 10" x 10")	1320mm x 260mm x 250mm (52" x 10" x 10")	1560mm x 260mm x 250mm (61" x 10" x 10")
Machine Weight	20kg	24kg	27kg	30kg
<b>Price</b>	<b>≤ \$413</b>	<b>≤ \$545</b>	<b>≤ \$578</b>	<b>≤ \$640</b>

**CPM-LD-1250SC: Vinyl Cutter-Special for Reflecting Film**

Specially designed for diamond grade reflecting film cutting

**With Artcut plotting software**

**Support CorelDraw output directly (with CorelDraw Driver)**

Up to 800g cutting force

Up to 800mm (31.5") / s cutting speed



- Standard HPGL language format, more compatibility by using USB interface for data transferring.
- Diamond Grade streamlined design, with a luxurious and modern appearance.
- Steel sting roller made with Japanese technology which guarantees motion precision - Single - key operation to regulate the force and speed independently.
- Professional controlling system allows high precision speed.
- Independent intelligence property right makes upgrade and maintenance convenient.
- Super-pressure: Can cut 3M thick and diamond grade reflecting film easily.

**▼ Specifications**

Model	CPM-LD-1250SC
Driver	Stepper motor
Maximum Media Width	1350mm (53")
Maximum Cutting Width	1250mm (49")
Maximum Cutting Speed	800mm (31.5") / s
Maximum Cutting Thickness	1mm (0.039")
Knife Press	0 - 500g (Digital adjustment)
Repeat Precision	±0.1mm (0.004")
Interface	COM, USB
RAM	128K-2M
Real Cutter Softball	Yes
Emergency Stop	Yes
Power Supply	AC110V / 220V, 50Hz / 60Hz
Machine Dimension	1560mm x 260mm x 250mm (61" x 10" x 10")
Machine Weight	33kg
<b>Price</b>	<b>≤ \$2,066</b>

## > Engraving Auxiliary Products

### CW-3000: Laser Specialized General Water Chiller

- It is designed for cooling the laser tube under 80W of the laser engraving and cutting machine.
- CW-3000 laser water chiller, comprehensive reference to the international radiator - type cooling system, is suitable for small water cooling device.
- Forces circulation. 9 L cooling tank capacity.
- It can extend the using life of laser tube and ensure the engraving effect better.
- Specific disconnection alarm securing protection.
- Enclosed water tanks, water used for a long time.
- Professional forced air - cooled radiator, high heat dissipating capacity and not easy to be blocked.
- Equipped with alarm output port, can quickly protect sensitive components.
- High cost performance, low failure rate.

#### ▼ Specifications

Model	CW-3000
Power Supply	AC110V - 240V, 50 / 60 Hz
Power Consumption	140VA
Tank Capacity	9L
Cooling	Radiator that forces the wind cooling
Amount of Cooling	50W / °C
Way of Circulation	Water pump forces circulation
Maximum Current Capacity	10L / min
Maximum Pumping Lift	8m (315")
Diameter of Input and Output	Outside Diameter: 10mm (0.39")
Machine Dimension	470mm x 262mm x 373mm (18.5" x 10.3" x 14.7")
Machine Weight	10kg
<b>Price</b>	<b>≤ \$230</b>



### CW-5000: Laser Specialized Water Chiller Plus

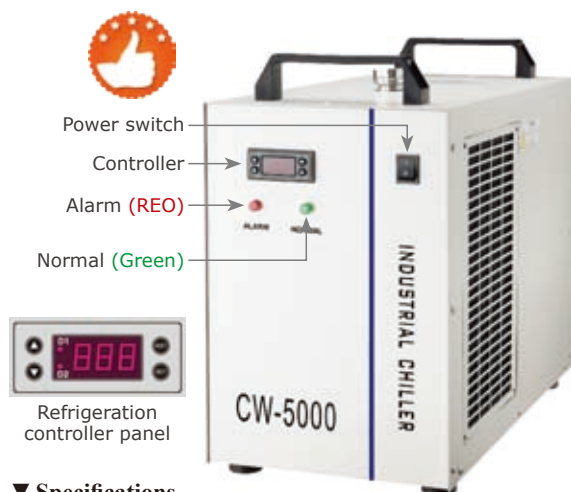

- It is suitable for cooling the laser tube under 150W, and the temperature can be adjusted precisely.
- You can choose different models according to local voltage and frequency.
- It can extend the using life of laser tube and ensure the engraving effect better.
- This series of water chillers adopt intelligent controller, which need not adjust the control parameters under normal circumstances, it will automatically adjust control parameters according to room temperature changes, to meet the cooling requirement.
- CW-5000 water chiller has unique low flow alarm protection function, which ensures the cooling water cycle working safely.
- Specific disconnection alarm securing protection.
- Enclosed water tanks, water used for a long time.
- Equipped with alarm output port, can quickly protect sensitive components.
- High cost performance, low failure rate.

#### ▼ Specifications

Model	CW-5000AG	CW-5000BG	CW-5000DG
Voltage	AC220 ~ 240V	AC208 ~ 230V	AC110V
Frequency	50Hz	60Hz	50 / 60Hz
Current	1.4 ~ 2.1A	1.4 ~ 2.1A	3.5 ~ 5.6A
Tank Capacity	6L	6L	6L
Cooling Capacity	2361Btu / h	2999Btu / h	2866Btu / h
Refrigerants	R-134a	R-134a	R-134a
Charge Amount	340g	340g	280g
Maximum Pump Lift	10m (394")	10m (394")	10m (394")
Input and Output	Outside Diameter: 10mm (0.39")		
Machine Dimension	550mm x 280mm x 430mm (21.6" x 11" x 16.9")		
Machine Weight	31kg	31kg	31kg
<b>Price</b>	<b>≤ \$540</b>	<b>≤ \$540</b>	<b>≤ \$540</b>

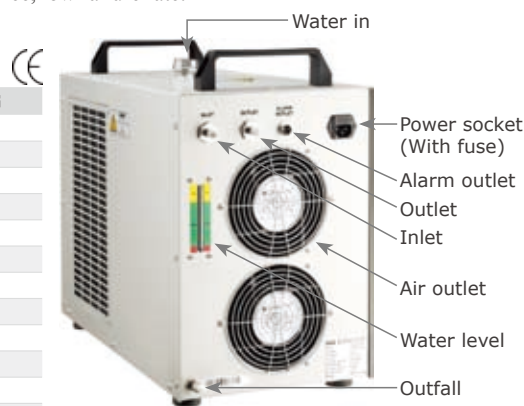

## &gt; Engraving Auxiliary Products

**CW-5200: Laser Specialized Water Chiller Plus**

- It is suitable for cooling double laser tubes under 150W, and the temperature can be adjusted precisely.
- This series of water chillers adopt intelligent controller, which need not adjust the control parameters under normal circumstances, it will automatically adjust control parameters according to room temperature changes, to meet the cooling requirement.
- CW-5000 water chiller has unique low flow alarm protection function, which ensures the cooling water cycle working safely.
- You can choose different models according to local voltage and frequency.
- It can extend the using life of laser tube and ensure the engraving effect better.
- Specific disconnection alarm securing protection.
- Enclosed water tanks, water used for a long time.
- Equipped with alarm output port, can quickly protect sensitive components.
- High cost performance, low failure rate.

**▼ Specifications**

Model	CW-5200AG	CW-5200BG	CW-5200DG
Voltage	AC220 ~ 240V	AC208 ~ 230V	AC110V
Frequency	50Hz	60Hz	60Hz
Current	2.4 ~ 3.1A	2.6 ~ 3.3A	4.5 ~ 6.5A
Tank Capacity	6L	6L	6L
Cooling Capacity	5084Btu / h	6295Btu / h	5186Btu / h
Refrigerants	R-22	R-22	R-22
Charge Amount	340g	340g	350g
Maximum Pump Lift	10m (394")	10m (394")	10m (394")
Input and Output	Outside Diameter: 10mm (0.39")		
Machine Dimension	550mm x 280mm x 430mm (21.6" x 11" x 16.9")		
Machine Weight	31kg	31kg	31kg
<b>Price</b>	<b>≤ \$560</b>	<b>≤ \$560</b>	<b>≤ \$560</b>

**CW-3000H: Spindle Specialized Water Chiller**

- It is designed for cooling the spindle of the CNC engraving machine.
- You can choose different models according to local voltage and frequency.
- CW-3000H water chiller, comprehensive reference to the international radiator - type cooling system, is suitable for small water cooling device.
- Specific disconnection alarm securing protection.
- Enclosed water tanks, water used for a long time.
- Professional forced air - cooled radiator, high heat dissipating capacity and not easy to be blocked.
- Equipped with alarm output port, can quickly protect sensitive components.
- High cost performance, low failure rate.

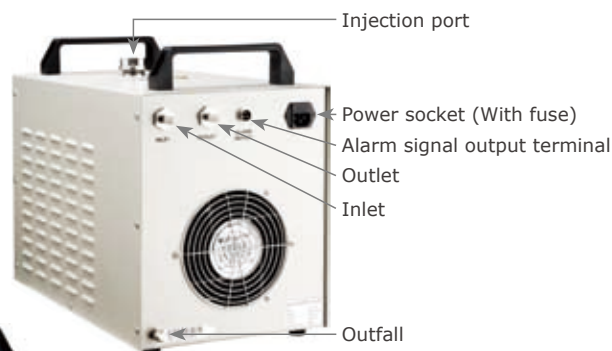
**▼ Specifications**

Model	CW-3000H
Power supply	AC100 ~ 120V / AC220 ~ 240V, 50 / 60 Hz
Current	1.0A / 0.5A
Tank Capacity	9 L
Cooling	Radiator that forces
Amount of Cooling	60W / °C
Way of Circulation	Forces circulation
Maximum Current Capacity	1 LPM
Maximum Pumping Lift	70m (2756")
Input and Output	Diameter: 6mm (0.24")
Machine Dimension	470mm x 270mm x 370mm (18.5" x 10.3" x 14.7")
Machine Weight	12kg
<b>Price</b>	<b>≤ \$230</b>



## &gt; Engraving Auxiliary Products

**CW-5000: Spindle Specialized Water Chiller Plus**

- It is designed for cooling the spindle of the CNC engraving machine.
- You can choose different model according to local voltage and frequency.
- This series of water chillers adopt intelligent controller, which need not adjust the control parameters under normal circumstances, it will automatically adjust control parameters according to room temperature changes, to meet the cooling requirement.
- CW-5000 water chiller has unique low flow alarm protection function, which ensures the cooling water cycle working safely.
- Specific disconnection alarm securing protection.
- Enclosed water tanks, water used for a long time.
- Equipped with alarm output port, can quickly protect sensitive components.
- High cost performance, low failure rate.

**▼ Specifications**

Model	CW-5000AK	CW-5000BK	CW-5000DK
Voltage	AC220 ~ 240V	AC208 ~ 230V	AC100 ~ 110V
Frequency	50Hz	60Hz	50 / 60Hz
Current	1.4 ~ 2.1A	1.4 ~ 2.1A	3.5 ~ 5.6A
Tank Capacity	6L	6L	6L
Cooling Capacity	2361Btu / h	2999Btu / h	2866Btu / h
Refrigerants	R-134a	R-134a	R-134a
Charge Amount	340g	340g	280g
Maximum Pumping Lift	70m (2756")	70m (2756")	70m (2756")
Input and Output	Dia.: 8mm (0.31")	Dia.: 8mm (0.31")	Dia.: 8mm (0.31")
Machine Dimension	550mm x 280mm x 430mm (21.6" x 11" x 16.9")		
Machine Weight	31kg	31kg	31kg
<b>Price</b>	≤ \$560	≤ \$560	≤ \$560

**CW-5200: Spindle Specialized Water Chiller Plus**

- It is designed for cooling the spindle of the CNC engraving machine.
- This series of water chillers adopt intelligent controller, which need not adjust the control parameters under normal circumstances, it will automatically adjust control parameters according to room temperature changes, to meet the cooling requirement.
- CW-5200 water chiller has unique low flow alarm protection function, which ensures the cooling water cycle working safely.
- You can choose different model according to local voltage and frequency.
- Specific disconnection alarm securing protection.
- Enclosed water tanks, water used for a long time.
- Equipped with alarm output port, can quickly protect sensitive components.
- High cost performance, low failure rate.



High-quality

**▼ Specifications**

Model	CW-5200AK	CW-5200BK	CW-5200DK
Voltage	AC220 ~ 240V	AC208 ~ 230V	AC100 ~ 110V
Frequency	50Hz	60Hz	50 / 60Hz
Current	2.4 ~ 3.1A	2.6 ~ 3.3A	4.5 ~ 6.5A
Tank Capacity	6L	6L	6L
Cooling Capacity	5084Btu / h	6295Btu / h	5186Btu / h
Refrigerants	R-22	R-22	R-22
Charge Amount	340g	340g	350g
Maximum Pumping Lift	10m	10m	10m
Input and Output	Dia.: 8mm (0.31")	Dia.: 8mm (0.31")	Dia.: 8mm (0.31")
Machine Dimension	550mm x 280mm x 430mm (21.6" x 11" x 16.9")		
Machine Weight	31kg	31kg	31kg
<b>Price</b>	≤ \$560	≤ \$560	≤ \$560



## &gt; Engraving Auxiliary Products

**ECG-GD-U2: Universal Cutter Grinder**

- For grinding HSS and carbide cutter, single lip or multiple lip cutters of various shapes, such as radius cutters or negative taper angle of cutters.
- The universal index head is provided at 24 positions so that any particular angle of shape can be obtained.
- It is allowed for the grinding to rotated 3600 or 100 with the End Mill Twist Drill Lathe tool, it only needs to be attached to the index head, and there is no complex setup.



## ▼ Specifications

Technical Parameter		Standard Accessories	
Item	Specification	Item	Qty.
Maximum Colet Capacity	Φ16mm (0.63")	Diamond Wheel Dresser	1 set
Maximum Grinding Dia.	Φ20mm (0.79")	Collets: 4mm (0.157") / 6mm (0.236") / 8mm (0.315")	3pc
Taper Angle	0 ~ 180 degree	Wrench Spanner Set	1 set
Relief Angle	0 ~ 45 degree	Grinding Wheel, PA100#	1pc
Negative Angle	0 ~ 26 degree	Wheel Mount	1pc
Grinding Spindle	5200 r.p.m.	Aligning Finger	1pc
Cup Grinding Wheel	100mm x 50mm x 20mm (3.9" x 2" x 0.8")	Lock Pin	1pc
Motor	1 / 3HP, 110V / 220V, 50 / 60Hz	Lamp	1pc
Machine Weight	50kg	User Manu	1pc
Machine Dimensions	450mm x 400mm x 350mm (18" x 16" x 14")	END mill grinding attachment Twist drill grinding attachment Lathe tool grinding attachment	Optional
<b>Price</b>	<b>≤ \$520</b>		

**ECG-GD-U3: Universal Cutter Grinder**

- For grinding HSS and carbide cutter, single lip or multiple lip cutters of various shapes, such as radius cutters or negative taper angle of cutters.
- The universal index head is provided at 24 positions so that any particular angle of shape can be obtained.
- It is allowed for the grinding to rotated 3600 or 100 with the End Mill Twist Drill Lathe tool, it only needs to be attached to the index head, and there is no complex setup.



## ▼ Specifications

Model	ECG-GD-U3	Accessories	Qty
Maximum Colet Capacity	Φ25mm (1")	Diamond wheel dresser	1pc
Maximum Grinding Dia.	Φ25mm (1")	Collets: 4mm (0.157") / 6mm (0.236") / 8mm (0.315")	3pc
Taper Angle	0 - 180 degree	Wrench spanner set	1pc
Relief Angle	0 - 45 degree	Grinding wheel	1pc
Negative Angle	0 - 52 degree	Wheel mount	1pc
Grinding Spindle	5200 r.p.m.	Aligning finger	1pc
Cup Grinding Wheel	100mm x 35mm x 20mm (3.9" x 1.4" x 0.8")	Lock pin	1pc
Motor	1 / 3HP, 110V / 220V, 50 / 60Hz	Drive belt	1pc
Machine Weight	50kg	Lamp	1pc
Machine Dimensions	450mm x 400mm x 350mm (18" x 16" x 14")	User Manu	1pc
<b>Price</b>	<b>≤ \$580</b>	END mill grinding attachment Twist drill grinding attachment Lathe tool grinding attachment	Optional

## &gt; Engraving Auxiliary Products

**CS-RM Series Mo 10.6μm CO2 Laser Reflection Mirrors for Engraving and Cutting**

Brand New, High Quality Reflective Mirror for CO2 Laser

**Diameter:** 30mm, 25mm, 20mm

**Thickness:** Approximate 3 mm

**Material:** Mo

**Coating:** No coated, just polished.

**Suitable for:** CO2 laser engraving & cutting machines

**▼ Features**

This optical element is used for planar reflecting the laser beam and is an important component of the laser system.

The biggest advantage of molybdenum mirror is it has high damage threshold. So it can be used in some high power laser systems such as laser engraving machines and laser cutting machines.

As a kind of high quality molybdenum mirrors, it has high reflectance and low flatness. Using the high quality surface coating will protect the layer of molybdenum not to damage, and increases the molybdenum layer reflection efficiency.

**▼ Specifications**

Part No.	Material	Diameter	Edge Thickness	Incident Angle	Coating	Price
CS-RM-20-3	Mo	0.79" (20mm)	0.12" (3mm)	45	No	≤ \$24
CS-RM-25-3	Mo	0.98" (25mm)	0.12" (3mm)	45	No	≤ \$24
CS-RM-30-3	Mo	1.18" (30mm)	0.12" (3mm)	45	No	≤ \$24

**CS-FL-ZM Series ZnSe Co2 Laser Focus Lens**

ZnSe lens for CO2 laser engraving and cutting!

Up for your bid is a high quality NEW ZnSe Plano - convex lens. The lens is 0.8" (20mm) / 0.75" (19.05mm) / 0.47" (12mm) in diameter, and has six kinds of focal lengths of 1.5" (38.1mm) / 2" (50.8mm) / 2.5" (63.5mm) / 3" (76.2mm) / 4" (101.6mm) / 5" (127mm) . It is coated for CO2 lasers at 10.6um wavelength.

This would be a great lens for a CO2 engraver or laser cutter, to focus the beam into a tight spot.

**▼ Specifications**

Part No.	Material	Diameter	EFL	E.T.	Coating	Price
CS-FL-ZM203812	ZnSe	0.79" (20mm)	1.5" (38.1mm)	2mm	AR @ 10.6um	≤ \$71
CS-FL-ZM205082	ZnSe	0.79" (20mm)	2" (50.8mm)	2mm	AR @ 10.6um	≤ \$71
CS-FL-ZM206352	ZnSe	0.79" (20mm)	2.5" (63.5mm)	2mm	AR @ 10.6um	≤ \$71
CS-FL-ZM207622	ZnSe	0.79" (20mm)	3" (76.2mm)	2mm	AR @ 10.6um	≤ \$71
CS-FL-ZM201012	ZnSe	0.79" (20mm)	4" (101.6mm)	2mm	AR @ 10.6um	≤ \$71
CS-FL-ZM201272	ZnSe	0.79" (20mm)	5" (127.0mm)	2mm	AR @ 10.6um	≤ \$71
CS-FL-ZM193812	ZnSe	0.75" (19.05mm)	1.5" (38.1mm)	2mm	AR @ 10.6um	≤ \$71
CS-FL-ZM195082	ZnSe	0.75" (19.05mm)	2" (50.8mm)	2mm	AR @ 10.6um	≤ \$71
CS-FL-ZM196352	ZnSe	0.75" (19.05mm)	2.5" (63.5mm)	2mm	AR @ 10.6um	≤ \$71
CS-FL-ZM197622	ZnSe	0.75" (19.05mm)	3" (76.2mm)	2mm	AR @ 10.6um	≤ \$71
CS-FL-ZM191012	ZnSe	0.75" (19.05mm)	4" (101.6mm)	2mm	AR @ 10.6um	≤ \$71
CS-FL-ZM191272	ZnSe	0.75" (19.05mm)	5" (127.0mm)	2mm	AR @ 10.6um	≤ \$71
CS-FL-ZM121862	ZnSe	0.47" (12mm)	0.7" (18.6mm)	2mm	AR @ 10.6um	≤ \$71

## &gt; Engraving Auxiliary Products

## CS-LT-Z Series RECI CO2 Laser Tube



Maximum 10,000 Hours Life Span  
Better Performance  
Higher efficiency



**Long life span:** We have catalyst plating in the inner wall of the laser tube. Designing lifespan is 10,000 hours and the warranty is 10 months. (No catalyst technique is used by other laser tubes manufacturers. Their lifespan is 3000 hours and the warranty is only 3 months)

**Appearance:** The tube is sealed by metal material. It is industrial product. (No metal material is used by other manufacturers. Their tubes are handmade and need extra water cooling for front and rare mirrors)

**Tube frame:** This is exclusive design for Reci laser tube. You can use it to install our laser tubes into the machine to spare the freight cost. This frame is shockproof and makes sure the tube will not move during the transport. (No frame is provided by other manufacturers.)

**High performance cost ratio:** When you buy Reci 80w tube, you can spare money for machine sheet metal, transport. Besides, you get 10 months warranty and the top level after sale service.



## ▼ Specifications

Model	CS-LT-Z2	CS-LT-Z4	CS-LT-Z6	CS-LT-Z8
Length	47" (1200mm)	47" (1400mm)	65" (1650mm)	72.8" (1850mm)
Power Output	Rated power 90w and Maximum power 100w	Rated power 120w and Maximum power 135w	Rated power 150w and Maximum power 170w	Rated power 170w and Maximum power 195w
Outer Diameter	∅ 3.15" (80mm) ± 2mm	∅ 80mm (3.15") ± 2mm	∅ 80mm (3.15") ± 2mm	∅ 90mm (3.54") ± 2mm
Ignition Voltage	19kv	24kv	28kv	30kv.
Operating Current	Test current is 29mA. Maximum working current is 29mA. The running current must be kept below 27mA. The life span can reach 8,000 hours if the current is kept below 25mA.	Test current is 29mA. Maximum working current is 30mA. The running current must be kept below 28mA. The life span can reach 8,000 hours if the current is kept below 26mA.	Test current is 29mA. Maximum working current is 32mA. The running current must be kept below 30mA. The life span can reach 8,000 hours if the current is kept below 28mA.	Test current is 29mA. Maximum working current is 32mA. The running current must be kept below 30mA. The life span can reach 8,000 hours if the current is kept below 28mA.
Power Stability	≤ ± 2%	≤ ± 2%	≤ ± 2%	≤ ± 2%
<b>Price</b>	<b>≤ \$480</b>	<b>≤ \$760</b>	<b>≤ \$1,570</b>	<b>≤ \$2,457</b>

## CS-PS-DY Series Reci Power Supply for Laser Tube

DY10 / DY13 / DY20, small size, quick response, it is suitable for Reci Z2 / Z4 / Z6 / Z8 laser tube.

We can supply AC110V and AC220V two style of power source, please tell us your voltage when order and inquiry.

## ▼ Features

This power supply adopts thin type design. The shape of this power supply is thin which is specially designed for special laser tube. The power supply makes laser tube output larger and more stable.

Quick Response: It can enlarge laser power and prolong laser tube's service life.

Easy Control: The start and stop of laser can be easily controlled by TTL level.

This power supply has output open circuit protection.

This power supply has TTL signal indication, water through signal indication and laser output indication.

This power supply has the BUTTON to test it work properly.

Application: Sculpture and cut acrylic, fabric, double color sheet and rubber, etc.

## ▼ Specifications

Model	CS-PS-DY10	CS-PS-DY13	CS-PS-DY20
Input Voltage	AC220V or AC110V	AC220V or AC110V	AC220V or AC110V
AC Frequency	47 - 440Hz	47 - 440Hz	47 - 440Hz
Maximum Input Power	450W	550W	1000W
Maximum Input current	5A	8A	10A
Maximum output Voltage	35KV	40KV	50KV
Maximum Output current	24mA	28mA	35mA
Efficiency	Equal or more than 90% ( load down )		
Time no-failure	Equal or more than 10000h		
Response speed	Equal or less than 1mS (the time from output of switch signal to 90% of initial setting current )		
Voltage - resisting	Input - Output ,input - machine hull: 1500V 10mA 60s; output cathode and machine hull connection		
Usage environment	Work temperature (-10 ~ 40) , Relative humidity: Equal or less than 90%		
Cooling Type	The compulsive air cooling		
<b>Price</b>	<b>≤ \$140</b>	<b>≤ \$156</b>	<b>≤ \$255</b>

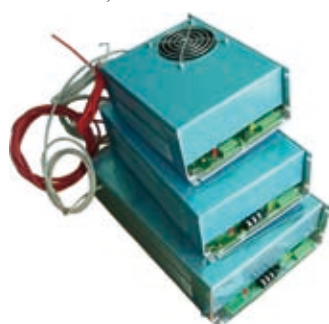



## > Engraving Auxiliary Products

### Brand New Laser Tube Water Cooling for the CO2 Laser Engraver



Industrial Laser Solution, 2,000 Hours Service Life

Good mode, high power, cost effective, suitable for advertising industry and other high precision engraving and simple cutting applications

We will send a new one freely if the tube is broken during transit.

Once received the laser tube, please check again the first time. We need the damaged record from the courier as the proof before we send the new one free.

Our laser tube 40W / 60W / 80W / 100W / 130W / 150W KY is manufactured by us and our technology to get until 10,000 working hours and the replacement is just about \$200 - \$850, better than any other; Emits a perfect laser beam. Easier alignment system, the laser tube lies up on stable and adjustable stands; Protection system to avoid sparks... better than others.

#### ▼ Specifications for industrial CO2 laser tubes

Model	CS-LT-KY40	CS-LT-KY60	CS-LT-80B	CS-LT-120B	CS-LT-150B
Nominal Power	40W	60W	80W	120W	150W
Power Output	Continuous output power 45 - 60W	Continuous output power 62W - 75W	Continuous output power 78W - 90W	Continuous output power 125W - 145W	Continuous output power 155W - 177W
Length	39.3" (1000mm)	49.2" (1250mm)	65" (1650mm)	65" (1650mm)	65" (1650mm)
Outer Diameter	φ 50mm (2")	φ 65mm (2.6")	φ 65mm (2.6")	φ 80mm (3.15")	φ 80mm (3.15")
Ignition Voltage	18kv	24kv	24kv	24kv	24kv
Performance Working Current	22mA	22mA	24mA	32mA	40mA
Power Instability	≤±5%	≤±5%	≤±5%	≤±5%	≤±5%
Beam Divergence Angle	≤ 4mrad	≤ 4mrad	≤ 3mrad	≤ 3mrad	≤ 3mrad
Spot Mode (Transverse Mode)	Low order mode	Low order mode	Low order mode	Low order mode	Low order mode
Spot Size	φ 4.0 ± 0.3mm	φ 5.5 ± 0.3mm	φ 6.5 ± 0.3mm	φ 7.5 ± 0.3mm	φ 8 ± 0.3mm
<b>Price</b>	<b>≤ \$236</b>	<b>≤ \$285</b>	<b>≤ \$540</b>	<b>≤ \$780</b>	<b>≤ \$850</b>

### Roland Vinyl Plotter Cutter Blades Knife - 5pcs / pack

Pack of 5 blades, knifepoint Offset 0.25, and 450-1500.

Vinyl cutting blade, long life OEM Blades

Superior OEM blades for sharpness and durability

Superior cutting of the most intricate designs

**Compatible with the following cutters: Our CPM-LD, CPM-FS-C, CPM-CUTOK, CPM-RS Series vinyl Cutters, Roland, Liyu, Redsail, Lidar, Jiachen and many more cutters on market.**

**LOWEST PRICES** - High quality blades are manufactured from China, solid carbide stock utilizing computer controlled CNC machines for precision and cutting accuracy.

Excellent for cutting vinyl, photo - stencil films & other thin films, etc.

The major difference for blades of different angles is cutting depth. 30 degree and 45 degree blades are great for thin materials, while 60 degree blade is great for thick materials.

**PS:** From the technical level, using a 60 degree blade on everyday cutting is a waste, less of the blade's cutting area is used, and blade life is wasted. The more horizontal cutting orientation of the 45 degree blade accurately distributes the cutting task over a larger blade area, and thus last longer. So use a 45 degree blade always, unless a 60 degree blade is needed for thick or more custom types of cutting, if 45 degrees blades are not available.

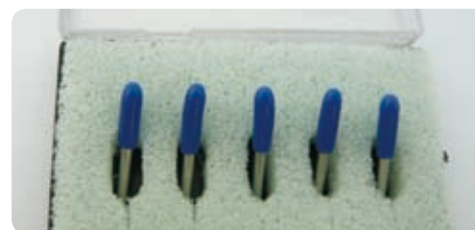

#### ▼ Specifications

Model	Grade	Angle	Price
RCCB-ROLAND30-AA	AA	30 degree	≤ \$12
RCCB-ROLAND45-AA	AA	45 degree	≤ \$12
RCCB-ROLAND60-AA	AA	60 degree	≤ \$12
RCCB-ROLAND30-3A	3A	30 degree	≤ \$20
RCCB-ROLAND45-3A	3A	45 degree	≤ \$20
RCCB-ROLAND60-3A	3A	60 degree	≤ \$20

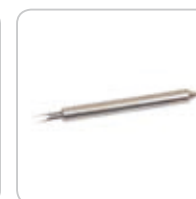
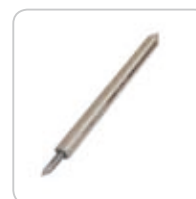

## &gt; Engraving Auxiliary Products

**5 Pack of Mimaki Cemented Carbide Blades Cutting Plotter Vinyl Cutter Knife**

5 pcs blades for Mimaki cutting plotter vinyl cutter, suitable for all kinds of industrial cutting materials, such as flocks, masking tape, reflective materials, vinyl etc.

5pcs in one plastic box, best quality reasonable price

Cutting plotter applicable: Mimaki

**▼ Feature**

Tungsten cemented carbide: Durable

High and new tech: Precise

Made in Cemented Carbide

High quality and Extra long life

Five blades in one box

Suitable for all Mimaki plotters

Blade size: 20mm (Length) x about 1.5mm (diameter)

Available angles for difference condition: 30, 45 and 60 degree

Knifepoint Offset 0.25 and 450-1500

Vinyl cutting blade, long life OEM Blades

Superior OEM blades for sharpness and durability

Superior cutting of the most intricate designs

**▼ Specifications**

Model	Grade	Angle	Price
RCCB-Mimaki30-AA	AA	30 degree	≤ \$22
RCCB-Mimaki45-AA	AA	45 degree	≤ \$22
RCCB-Mimaki60-AA	AA	60 degree	≤ \$22
RCCB-Mimaki30-3A	3A	30 degree	≤ \$34
RCCB-Mimaki45-3A	3A	45 degree	≤ \$34
RCCB-Mimaki60-3A	3A	60 degree	≤ \$34

## > Channel Letter Making Machine and Material

### CS-HD-BC06: Manual Acrylic Letter Making Bending Machine Tool

**Processing Material:** Acrylic

Includes two benders, one for angle bending, and another one for arc bending

**Voltage:** 100 - 240V

**Power:** Angle bending 60W, Arc bending 39W

**Heating Temperature:** 200°C ± 5%

**Arc Heater size:** 100mm x 50mm x 2mm

**Angle Heater Size:** 100mm x 2.5mm x 2mm

**Arc bending soft time (2.5mm thickness, 20°C):** About 9 seconds

**Angle bending soft time (2.5mm thickness, 20°C):** About 3 seconds



#### ▼ Features

- The two benders is ideal for acrylic channel letter making, they adopt PTC heating elements, which have features of safe and energy - saving, fast heat up, durable, automatic temperature control, and easy operation.
- Aluminum alloy thermal conductive plate is heating even, it can automatic adjust the angle between heating plate and acrylic.
- It is suitable for heating acrylic within 1.5mm - 4mm thickness.
- Adopts high quality heat - resistant engineering plastics, non - stick the acrylic sheet.

**Price:** ≤ \$42



### ABM-BT Series Manual Acrylic Letter Bending Machine Heater

This acrylic letter bending machine heater can be widely used in decoration engineering, sign making, display cabinet, aquarium wrapping, bending the supermarket shelves, curtain wall, large light box, acrylic plates and plastic plates.

The heater is the core part of letter bending machine. You can assemble various kinds of ideal practical acrylic bender with it.

**Include:** 1 pc of Heater, 1 pc of water pump, 2 pcs of silicone hose, 1 pc of temperature controller



- It can bend all kinds of plastic sheet. If the thickness of acrylic sheet is beyond 6mm, you can use two heaters heat the top and bottom of the sheet at the same time, or you need to cut a slot on the sheet.
- You can also use many heaters to heat more bents at the same time.
- Reasonable design, small size, compact structure and beautiful appearance;
- Heat even and temperature adjustable;
- With circulating cooling water system on both sides of heating pipe;
- Power supply joint and waterpipe joint are at the same end;
- The body is made of special aluminum extrusions.

#### ▼ Samples

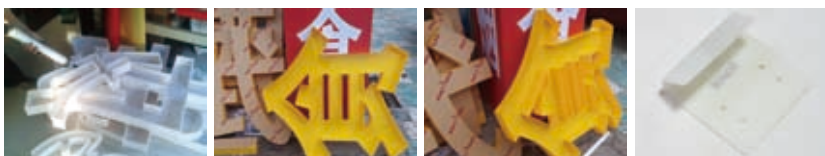

#### ▼ Specifications

Model	ABM-BT-300	ABM-BT-600	ABM-BT-1200	ABM-BT-1800	ABM-BT-2400
Maximum Bending Width	300mm (12")	610mm (24")	1220mm (48")	1830mm (72")	2440mm (96")
Power	1500W	1500W	1500W	1500W	1500W
Power Supply	AC 110V - 220V	AC 110V - 220V	AC 110V - 220V	AC 110V - 220V	AC 110V - 220V
Heating Slot Width	8mm (0.31")	8mm (0.31")	8mm (0.31")	8mm (0.31")	8mm (0.31")
Heating Thickness	1 - 6mm (0.39" - 0.24")	1 - 6mm (0.39" - 0.24")	1 - 6mm (0.39" - 0.24")	1 - 6mm (0.39" - 0.24")	1 - 6mm (0.39" - 0.24")
Heater Size	45mm x 45mm x 520mm (2" x 2" x 20.5")	45mm x 45mm x 850mm (2" x 2" x 33.5")	45mm x 45mm x 1480mm (2" x 2" x 58")	45mm x 45mm x 2010mm (2" x 2" x 79")	45mm x 45mm x 2680mm (2" x 2" x 105")
<b>Price</b>	≤ \$75	≤ \$108	≤ \$146	≤ \$150	≤ \$158

## > Channel Letter Making Machine and Material

### Metal Channel Letter Bending Machine

- Fast bending speed. Relative to the other metal bending machines adopt pat way to bend, this machine adopts rolling bending way; its finished work piece looks more smooth, beautiful, and without any trace.
- Independent research and development software, which has independence knowledge property and you can enjoy free software upgrades and technical services for life.
- High bending precision, it can make Endless letters, which are highest precision three - dimensional letters on the market.
- With many domestic invention patent.
- Through the PCT property rights protection, has applied for the patent in the European Union.



#### ▼ Specifications

Model	MBM-HD-SK-C	MBM-HD-SK-V	MBM-HD-SK-VI	MBM-HD-SK-S
Processing Material	Aluminum	Aluminum	Aluminum	Steel, Iron, Copper
Material Thickness	0.2mm - 1.2mm	0.2 - 1.5mm	0.2 - 1.5mm	0.4 - 1.2mm
Material Height	90mm (3.5")	100mm (3.9")	135mm (5.3")	140mm (5.5")
Speed	400 - 800m / 8 hour	600 - 1000m / 8 hour	800 - 1200m / 8 hour	600 - 1000m / 8 hour
Working Principle	Auto feed, Auto Slot (Cut), Auto Bend			
Slot Degree	45-135 Degree			
Min Bending Diameter	≥ 15mm	≥ 12mm	≥ 12mm	≥ 12mm
Voltage	220V	220V	220V	220V
Power	500W	500W	500W	3000W
Machine Size	700mm x 400mm x 700mm	1400mm x 700mm x 1400mm	1500mm x 800mm x 1400mm	1600mm x 1000mm x 1600mm
Machine Weight	40kgs	210kgs	300kgs	500kgs
File Format	AI	AI	AI	AI
Configuration	Low	Medium	High	High
<b>Price</b>	<b>≤ \$5,372</b>	<b>≤ \$8,369</b>	<b>≤ \$8,596</b>	<b>≤ \$18,100</b>

**Remark: Custom height available.**

**Available HD aluminum coil only, no this limit on flat material.**

#### ▼ Samples



## > Channel Letter Making Machine and Material

### CS-HD-BC Series Small Size Cutting Machine

**Processing Material:** Aluminum, Iron, Steel, Acrylic, PVC

**Max Cutting Width:** 15cm (5.9")

**Max Cutting Thickness:** Adjustable & No limited

**Cutting Way:** 90 degree & V - Cutting

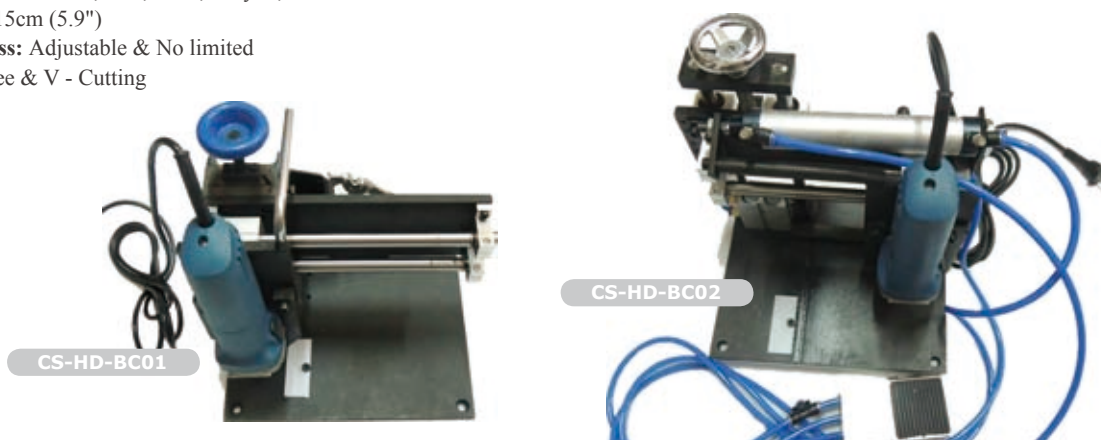

CS-HD-BC01

CS-HD-BC02

#### ▼ Specifications

Model	CS-HD-BC01	CS-HD-BC02
Processing Material	Aluminum, Iron, Steel, Acrylic, PVC	Aluminum, Iron, Steel, Acrylic, PVC
Operation Method	Electric	Pneumatic
Cutting Way	90 degree & V - Cutting	90 degree & V - Cutting
Maximum Cutting Width	15cm (5.9")	15cm (5.9")
Maximum Cutting Thickness	Adjustable & No limited	Adjustable & No limited
Power Supply	AC 100V - 220V	AC 100V - 220V
Machine Dimension	300mm x 350mm x 380mm (12" x 14" x 15")	300mm x 350mm x 380mm (12" x 14" x 15")
Machine Weight	39.6ib (18kg)	48.4ib (22kg)
<b>Price</b>	<b>≤ \$429</b>	<b>≤ \$512</b>

### CS-HD-BC03 Series Saw Blade, Cutting Blade

Used for metal cutting machine CS-HD-BC01 and CS-HD-BC02



CS-HD-BC03

CS-HD-BC03-I

#### ▼ Specifications

Model	CS-HD-BC03	CS-HD-BC03-I
Processing Material	Aluminum	Stainless steel, Aluminum, Acrylic, PVC steel
Blade Texture	Iron alloy	Tungsten
Cutting Way	90 degree & V - Cutting	90 degree & V - Cutting
Blade Diameter	100mm (3.9")	100mm (3.9")
Maximum Cutting Thickness	1.2mm (0.047")	1.2mm (0.047")
<b>Price</b>	<b>≤ \$40</b>	<b>≤ \$96</b>

### CS-HD-BC05: 5 Sets of Manual Bender Sets

**Bender Diameter:** 20mm (0.79"), 30mm (1.18") & 50mm (1.97")

**Processing Material:** Aluminum

**Price:** ≤ \$63 / set





## &gt; Channel Letter Making Machine and Material

**Metal Channel Letter Making Material Color Aluminum Coil**



- All coils are aluminum, light weight and durable;
- Good weathering resistance, never rust;
- Used for making Dimensional Sign Letter;
- Double fold design in top edge for letter face attached. No need trim - cap anymore;
- Paint Spray.
- Can adhesive the letter face instantaneously by 502 super glue after inside surface special treatment;
- Simply, easily and quickly to make sign letters.
- Apply to all kinds of Channel Letter Benders.

## ▼ Specifications

	Model	Name	Color	Thickness	Width	Length	Pack	Price / Pack
	CS-SJT85-D	25 Pack of 85mm (3.3") x 6m (19.7 feet) Double - Side Color Aluminum Coil	Double - Side White	1mm ± 0.2	85mm (3.3")	6m	150m / 25pcs	≤ \$356.78
			Double - Side Black	1mm ± 0.2	85mm (3.3")	6m	150m / 25pcs	≤ \$356.78
			Double - Side Brush Gold	1mm ± 0.2	85mm (3.3")	6m	150m / 25pcs	≤ \$356.78
			Double - Side Brush Silver	1mm ± 0.2	85mm (3.3")	6m	150m / 25pcs	≤ \$356.78
	CS-SJT60-D	25 Pack of 60mm (2.4") x 6m (19.7 feet) Double - Side Color Aluminum Coil	Double - Side White	1mm ± 0.2	60mm (2.4")	6m	150m / 25pcs	≤ \$278.46
			Double - Side Black	1mm ± 0.2	60mm (2.4")	6m	150m / 25pcs	≤ \$278.46
			Double - Side Silver	1mm ± 0.2	60mm (2.4")	6m	150m / 25pcs	≤ \$278.46

	Model	Name	Color	Thickness	Width	Length	Pack	Price / Pack
	CS-PT83-D	25 Pack of 83mm (3.3") x 6m (19.7 feet) Double - Side Color Aluminum Coil	Double - Side White	1mm ± 0.2	83mm (3.3")	6m	150m / 25pcs	≤ \$356.78
			Double - Side Black	1mm ± 0.2	83mm (3.3")	6m	150m / 25pcs	≤ \$356.78
			Double - Side Brush Silver	1mm ± 0.2	83mm (3.3")	6m	150m / 25pcs	≤ \$356.78
	CS-PT60-D	25 Pack of 60mm (2.4") x 6m (19.7 feet) Double - Side Aluminum Coil	Double - Side White	1mm ± 0.2	60mm (2.4")	6m	150m / 25pcs	≤ \$278.46
			Double - Side Black	1mm ± 0.2	60mm (2.4")	6m	150m / 25pcs	≤ \$278.46

	Model	Name	Color	Thickness	Width	Length	Pack	Price / Pack
	CS-DF88-Mirror	2 Rolls of 88mm (3.3") x 50m (164 feet) Mirror Silver Folding Aluminum Coil	Mirror Silver	0.5mm (0.02")	88mm (3.3")	50m	2 rolls	≤ \$233.02
	CS-DF88-Silver	2 Rolls of 88mm (3.3") x 50m (164 feet) Brush Silver Folding Aluminum Coil	Brush Silver	0.6mm (0.024")	88mm (3.3")	50m	2 rolls	≤ \$170.36
	CS-DF88-Gold	2 Rolls of 88mm (3.3") x 50m (164 feet) Brush Gold Folding Aluminum Coil	Brush Gold	0.6mm (0.024")	88mm (3.3")	50m	2 rolls	≤ \$170.36
	CS-DF88	2 Rolls of 88mm (3.3") x 50m (164 feet) Folding Color Aluminum Coil	Black	0.6mm (0.024")	88mm (3.3")	50m	2 rolls	≤ \$146.87
			Yellow	0.6mm (0.024")	88mm (3.3")	50m	2 rolls	≤ \$146.87
			Green	0.6mm (0.024")	88mm (3.3")	50m	2 rolls	≤ \$146.87
			Blue	0.6mm (0.024")	88mm (3.3")	50m	2 rolls	≤ \$146.87
			White	0.6mm (0.024")	88mm (3.3")	50m	2 rolls	≤ \$146.87
			Aluminum	0.6mm (0.024")	88mm (3.3")	50m	2 rolls	≤ \$146.87
	CS-DF60-Silver	2 Rolls of 60mm (2.4") x 50m (164 feet) Silver Folding Aluminum Coil	Brush Silver	0.6mm (0.024")	60mm (2.4")	50m	2 rolls	≤ \$141.65
	CS-DF60	2 Rolls of 60mm (2.4") x 50m (164 feet) Color Folding Aluminum Coil	Black	0.6mm (0.024")	60mm (2.4")	50m	2 rolls	≤ \$123.37
			White	0.6mm (0.024")	60mm (2.4")	50m	2 rolls	≤ \$123.37

	Model	Name	Color	Thickness	Width	Length	Pack	Price / Pack
	CS-FL60	60mm (2.4") x 200m (656 feet) Flat Aluminum Coil	White	0.6mm (0.024")	60mm (2.4")	200m	1 roll	≤ \$206.91
			Black	0.6mm (0.024")	60mm (2.4")	200m	1 roll	≤ \$206.91
			Yellow	0.6mm (0.024")	60mm (2.4")	200m	1 roll	≤ \$206.91
			Green	0.6mm (0.024")	60mm (2.4")	200m	1 roll	≤ \$206.91
			Blue	0.6mm (0.024")	60mm (2.4")	200m	1 roll	≤ \$206.91
	CS-FL98	98mm (3.9") x 200m (656 feet) Color Flat Aluminum Coil	Black	0.6mm (0.024")	98mm (3.9")	200m	1 roll	≤ \$293.93
			White	0.6mm (0.024")	98mm (3.9")	200m	1 roll	≤ \$293.93
			Red	0.6mm (0.024")	98mm (3.9")	200m	1 roll	≤ \$293.93
			Yellow	0.6mm (0.024")	98mm (3.9")	200m	1 roll	≤ \$293.93
			Green	0.6mm (0.024")	98mm (3.9")	200m	1 roll	≤ \$293.93
			Blue	0.6mm (0.024")	98mm (3.9")	200m	1 roll	≤ \$293.93

**Remark:** "F" means Flat strip; "DF" means Double Folded Edge; "FL" means Flat sheet without edge.

## > Acrylic Finishing Machine

It is designed by our scientific researcher under the heat expert personal guidance, and uses the principle of digital computer vacuum frequency conversion control and suction pressure.

### Analysis of the Advertising Acrylic Suction Products Market

**Acrylic vacuum machine (Also called Plastics Absorbing Equipment) is the most profitable equipment in advertising industry.**

Our Product can be applied to the advertising enterprises that are specialized in processing and manufacturing.

Using acrylic vacuum machines, you can make acrylic suction model product.

The most typical application is light box at the door head and logo signs in McDonald's and KFC.

Right, it is made from acrylic vacuum machine.

Blister Light Box has features of high three - dimension effect, high transmittance (Can up to 95%), resistance heat and cold, environmental protection, anticorrosion, long time for outdoor using, which can be up to 8 - 15 years.



### Application Area of Acrylic products

Advertising signs, chain logos  
Store name, store mark, price label  
Outdoor beams advertising, chapter advertising  
Space formula promotional advertising

### Analysis of Investment of Acrylic Vacuum Machine

**Investment:** According to your personal state, you need to invest about \$6,000 - \$35,000.

**The Cost Involved In:** Acrylic board, mould, acrylic vacuum machine, lamps and lanterns, electricity fee, pay for your worker, rent and so on.

**Make Profits:** Combined costs of above mentioned is compare with the producing capacity, usually, you can recover the investment or begin to make profits one month later.

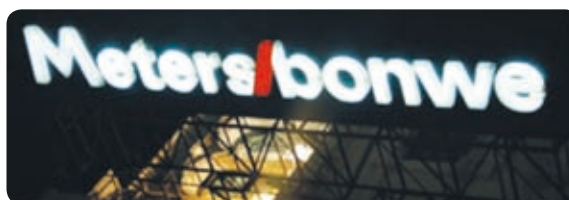

### Promotion Strategy

- With your business development, maybe you have had certain old customers, they want to attain acrylic suction model product, and this is a good choice for you to buy an acrylic vacuum machine to extend your business.
- Develop new business field, locating a certain industry, such as financial, telecom.
- Develop your own deputy: To give a reasonable profit margin, using the customer resources of your deputy, partners will become competitors.

## &gt; Acrylic Finishing Machine

**AVM-SB Series Semi - auto CNC Acrylic Vacuum Blowing Machine**

Using acrylic vacuum machines, you can make acrylic suction model products. The most typical application is light box at the door head and logo signs in McDonald's and KFC. Other applications include advertising signs, chain logos, store name, store mark, price label, outdoor beams advertising, chapter advertising, and space formula promotional advertising.

- Pneumatic switch, separate heating box that saves electricity.
- Rack balancing system, movement system.
- Thermo cycling fan, digital temperature control system.
- Hydraulic system, vacuum meter, automatic alarm system.
- Movable clamp with no rejection.
- Working table made of steel.
- You can choose your favorite color, between red, blue, and grey.
- Edge milling machine for free with the machine.



## ▼ Samples



## ▼ Specifications

Model	AVM-SB-3200A	AVM-SB-2600A	AVM-SB-1600A
Maximum Working Area	3000mm x 2000mm (118" x 79")	2400mm x 1200mm (94" x 48")	1400mm x 1200mm (55" x 48")
Maximum Depth	300mm (12")	250mm (10")	250mm (10")
Hydraulic Pressure	1T - 20T	1T - 20T	1T - 20T
Maximum Sheet Thickness	20mm (0.8")	20mm (0.8")	20mm (0.8")
Temperature	0°C - 300°C	0°C - 300°C	0°C - 300°C
Voltage	380V, 50Hz	220V, 50Hz / 380V, 50Hz (Optional)	220V, 50Hz / 380V, 50Hz (Optional)
Maximum Heating Power	18KW	9KW	6KW
Machine Dimension	3200mm x 2200mm x 2350mm (126" x 87" x 92")	2600mm x 1400mm x 2400mm (102" x 55" x 94")	1700mm x 1400mm x 2300mm (67" x 55" x 90")
Machine Weight	3000kg	2800kg	2200kg
Package	Plastic film package	Plastic film package	Plastic film package
<b>Price</b>	≤ \$6,170	≤ \$5,750	≤ \$4,850



## > Acrylic Finishing Machine

### Full - Auto CNC Acrylic Vacuum Blowing Machine

Using acrylic vacuum machines, you can make acrylic suction model products. The most typical application is light box at the door head and logo signs in McDonald's and KFC. Other applications include advertising signs, chain logos, store name, store mark, price label, outdoor beams advertising, chapter advertising, and space formula promotional advertising.



- Pneumatic switch
- This machine is feasible to compose and fold
- Automatic balancing system by rack gear
- Vacuum system
- Digital temperature control system
- Hydraulic system
- Auto - alarm system
- Working table are made of steel
- Automatic feeding function, sends the material to the working table automatically

#### ▼ Specifications

Model	AVM-D-3200AA	AVM-D-2600AA	AVM-D-1600AA
Machine Size	3200mm x 2200mm x 2700mm (126" x 86.6" x 106")	2600mm x 1400mm x 2400mm (102" x 55" x 94")	1700mm x 1400mm x 2300mm (67" x 55" x 91")
Maximum Working Area	3000mm x 2000mm (118" x 79")	2400mm x 1200mm (94" x 47")	1400mm x 1200mm (55" x 47")
Maximum Vacuum Depth	300mm (11.8")	250mm (9.8")	250mm (9.8")
Weight	3T	2.8T	2.2T
Hydraulic pressure	1T - 20T	1T - 20T	1T - 20T
Max Sheet thickness	20mm (0.79")	20mm (0.79")	20mm (0.79")
Temperature	0°C - 300°C	0°C - 300°C	0°C - 300°C
Voltage	380V, 50Hz	380V, 50Hz / 220V, 50Hz	380V, 50Hz / 220V, 50Hz
Maximum heating power	10KW	9KW	6KW
<b>FOB Price</b>	<b>≤ \$14,900</b>	<b>≤ \$13,000</b>	<b>≤ \$12,800</b>

### APM-H180: Acrylic Polishing Machine

Synthetic glass (acrylic) polishing. Oxy - hydrogen generator is a machine using high temperature flame to make acrylic edge smooth and bright. **Compact size, light weight, energy saving, easy to operate, safer and more reliable**  
Its maximum output gas is up to 90 l / h.



- H180 is updated from H100, it is economical type Acrylic flame polishing machine.
- Its electrolyze adopts series and parallel compound technique, which makes the electrolysis more efficient.

#### ▼ Specifications

Model	APM-H180A	APM-H180B
Input Voltage	AC110 - 220V	AC110 - 220V
Rated Output Gas (L / H)	≥ 95	≥ 95
Operation Gas Pressure (MPa)	0.08 - 0.13	0.08-0.13
Ambient Temperature	-10°C - 40°C	-10°C - 40°C
Flame Temperature	≥ 2800°C	≥ 2800°C
Water Consumption (L / H)	0.03	0.03
Flame Gun No.	Single	Double
<b>Price</b>	<b>≤ \$185</b>	<b>≤ \$190</b>

## &gt; Acrylic Finishing Machine

**ABM-SB Series Acrylic Bending Machine**

Bending materials like acrylic, plastic, PC, PVC and PP. This hot bending process equipment can adjust any angle and shape within 30 - 180 degree.

- Automatic and manual function with CNC operation
- Automatic function to bend the sheet
- Softening crevice can be adjusted according to the thickness of plate
- The heating plate can be fixed avoiding defamation
- The Acrylic Bending Machine has an infrared heating system to prolong the lifespan for more time rather than the hot furnace filament.
- The temperature and working voltage can be adjusted according to the material and thickness.
- Water circulation protects the configuration and the overheating alarm temperature ensures the safety of the machine.
- The current package protects the equipment.
- **Thickness range ending:** 0.8mm to 6mm (There is no need to cut a slot on the sheet)  
6mm to 20mm (There is need to cut a slot on the sheet)

## ▼ Samples

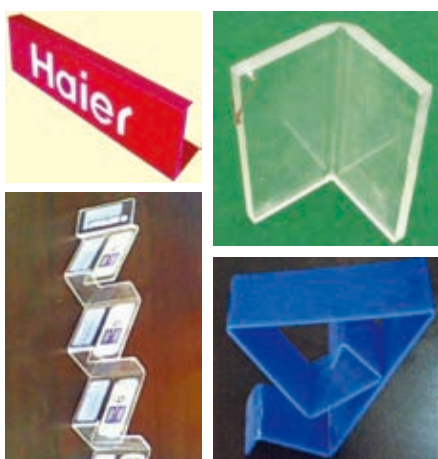

## ▼ Specifications

Model	ABM-SB-1200A	ABM-SB-1800A	ABM-SB-2400A	ABM-SB-3000A
Angle	30° - 180°	30° - 180°	30° - 180°	30° - 180°
Bending Thickness	0.8mm - 20mm (0.03" - 0.8")	0.8mm - 20mm (0.03" - 0.8")	0.8mm - 20mm (0.03" - 0.8")	0.8mm - 20mm (0.03" - 0.8")
Working Length	1200mm (48")	1800mm (71")	2400mm (94")	3000mm (118")
Power	6KW (Working power 2Kw)	6KW (Working power 2Kw)	7.5KW (Working power 2.5Kw)	10.5KW (Working power 3.5Kw)
Machine Dimension	1680mm x 440mm x 1100mm (66" x 17" x 43")	2280mm x 440mm x 1100mm (90" x 17" x 43")	2800mm x 440mm x 1100mm (110" x 17" x 43")	3500mm x 480mm x 1100mm (137" x 18.8" x 44")
Machine Weight	140kg	170kg	220kg	320kg
<b>Price</b>	≤ \$2,010	≤ \$2,270	≤ \$2,790	≤ \$2,930

## > Engraving Supplies > Engraving bits

We offer a variety of engraving tools now. These engraving tools we supplied are designed for computer engraving machine, high precision engraving machine, which are small in shank diameter, and high in processing precision engraving tools.

These engraving tools are widely used in field of mould processing, industry manufacture, electronics, craft, furniture, woodworking, and advertising making. These tools can process metals, plastics, acrylics, resin, ply board, MDF, other woods and so on.

Meanwhile, we can offer special engraving tool as your requirement.

### ▼ Specifications

Pictures	Name	Processing Materials and Features
	One Flute Spiral Sharp Bits	Stainless steel, mould steel, aluminum, brass, hardwood
	Solid Carbide Ball End Mills	Cast iron, carbon steel and hardened steel
	Corner Radius End Mills	Cast iron, carbon steel and hardened steel
	Six Flat Flute End Mills	Cast iron, carbon steel and hardened steel
	Two Flute End Mills For Aluminum	Cast iron, carbon steel and hardened steel
	Four Flat End Mills Long SHK	Cast iron, carbon steel and hardened steel
	Four Flat Flute End Mills	Cast iron, carbon steel and hardened steel
	Two Flat Flute End Mills	Cast iron, carbon steel and hardened steel
	One Flute Compression Cutters	PVC, Cotton rose board, the side from the top to bottom superficial burr - free
	Classical Ogee Bits	Lace inverted - processing, can be designated for the customer
	Cleaning Bottom Bits	Milling - large table and large sculpture
	PCB End Mills	High density board, solid wood, hardwood, PCB
	Two Straight Flute Bits	Multilayer PCB, plywood, MDF
	Two Large Flute Spiral Bits	MDF, PVC, Cotton rose board
	Two Flute Spiral Bits	Acrylic, MDF, PVC
	One Flute Down Cut Spiral Bits	Clamping plank, MDF cutting, ALICE DONT board
	One Flute Spiral Bit for Aluminum	Aluminum cutting, non - stick, sword
	One Flute Spiral Bits	Acrylic, PVC, cotton rose board, MDF, plastics
	Half Straight Cutter	ABS, acrylic, IC, card for cutting and engraving
	Radiused Bottom Bits	Acrylic, hardwood, aluminum, steel
	3D Engraving Bits	Acrylic, hardwood, aluminum, steel
	Pyramid Tools	Aluminum, stainless steel, steel, fine jade carving
	Two Straight Flute Engraving Bits	Steel, stainless, hardwood, gradient cut off
	One Straight Flute Bits	Aluminum, stainless steel, steel, brass
	Flat Bottom Engraving Bits	ABS, Acrylic, MDF, PVC, plate sculpture cutting, relief rough

▼ **Diamond Tools**

Pictures	Name	Processing Materials and Features
	Diamond Flat Bottom Engraving Bits	Good For: Acrylic, aluminum, brass, marble Features: Boast of high precision and good smooth finish
	Diamond Four Face Engraving Tools	Good for: Marble, hardwood for engraving
	Diamond V Cutters	Good For: Acrylic, MDF, aluminum, brass, marble Features: Boast of high precision and good smooth finish
	Diamond Half Straight Cutter	Good for: Acrylic, PC board ,PMMA, MDF, aluminum, brass, hardwood Features: Boast of high precision and good smooth finish
	Diamond Radiuses Bottom Engraving Bits	Acrylic, hardwood, brass, aluminum, marble relief sculpture engraving
	Diamond Router Bits	Shaving board, MDF, aluminum board, hardwood, acrylic Features: Boast of high precision and good smooth finish

▼ **Recommended Engraving Tools**

**One Flute Spiral Bits:** Designed with spiral cutting chute of high capacity and mirror - like tool grinders, and equipped with ultra - micron tungsten steel bits, this style of cutters is of great use in the high efficient mass production of such materials as acrylic, PVC, plastics, soft wood and MDF. In addition, it is really a kind of environment - friendly carving tools as it guarantees a non - stick, smokeless, smellless and muting processing.

**Two Large Flute Spiral Bits:** This model of cutting tool is especially suitable for the mid - low density board processing, it has the characteristics for the escape of chips well, not black knife, not burning the board, the processing efficiency is higher.

**One Flute Spiral Bits for Aluminum:** This kind of tools are most useful to cut various kinds of aluminum plates, and can guarantee a non - stick, high efficient cutting process while the carving machine is rotating at a high speed.

**Two Straight Flute Bit:** The straight flute milling cutter is different from the spiral bits in escape of chips performance and the milling effect. It can process the density board, the clamping plank, the shaving board, each kind composite plank, as well as products which has no processing effect in spiral bits. Once it will be a very good cost - effective cutting tool.

**3D Engraving Bits:** High precision, hard wearing, it is designed with real double edges, single whole tungsten steels and stainless steel shanks and tips cut by digital controlled tool grinders.

**Plotter Blades:** We provide you with kinds of plotter blades, such as Roland, Pcut.

**Depending on market demand, we will provide you with a variety of price points and quality of the tool. Bellowing are four grades of engraving tool.**

**AA Series**

- Be made from Germany K55UF ultra - micron tungsten steel
- It's a kind of precise engraving tools with high quality.
- Featuring hardness of 94 HRC and super resistance to bend, its resistance to rub and stability are superior to other solid carbide materials.
- Because of the high cost of the materials, the longest SHK of this series is 6mm. With the patent polishing process; the cutting tools are very sharp.
- Engraving tools are excellent in engraving aluminum, stainless steel, steel.
- Mills are excellent in processing rate and quality among acrylic, MDF and aluminum.
- AA series is the top engraving tools consequent to A series after great investment and three years' design, development and improvement. Its quality is superior to European and American ones.

**A Series**

- Adopts K200 Micro grain solid carbide
- A series is a kind of cutting tools targeted at low - cost high - quality, customers who have used these tools are all amazed by its high efficiency and high benefits.

**N Series**

- N series is a kind of popular engraving tools adopts K10 micro grain solid carbide.
- Put out by our company in the early days. With engraving measurement and outstanding sales achievements, its excellent quality and low price meet the engraving need of most customers.

**Diamond Series**

- Diamond engraving tools are designed and developed to cut metal, such as aluminum, brass, steel, acrylic and marble.
- The price is competitive higher than other cutters.

**If you need detailed information of engraving tools, please refer to our website [www.Sign-in-China.com](http://www.Sign-in-China.com).**



## &gt; Engraving Supplies &gt; Cutting self - adhesive vinyl &amp; squeegees

## Cutting Self - adhesive Vinyl

**Application:** These products are used to stick to acrylic plate, soft signboard cloth, glass, painted metal plate, and other boards.

And they can also be used to computer graphic, lettering, cutting and plotting.

Almost all series have two styles: Opaque and Matte.



G-3015	G-3037	G-3003	G-3020	G-3201
M-3178	M-3157	M-3173	M-3150	M-3381
G-3017	G-3039	G-3004	G-3090	G-3201
M-3151	M-3156	M-3174	M-3195	M-3382
G-3013	G-3016	G-3005	G-3038	G-3203
M-3152	M-3148	M-3175	M-3166	M-3383
G-3013	G-3018	G-3029	G-3043	G-3206
N-3152	M-3148	M-3170	M-3185	M-3386
G-3012	G-3025	G-3006	G-3031	G-3207
M-3142	M-3179	M-3177	M-3172	M-3387
G-3014	G-3041	G-3007	G-3022	G-3208
M-3144	M-3181	M-3181	M-3176	M-3388
G-3019	G-3034	G-3028	G-3145	G-3209
M-3147	M-3164	M-3158	M-3137	M-3389
G-3011	G-3023	G-3030	G-3088	G-3210
M-3180	M-3169	M-3160	M-3197	M-3370
G-3027	G-3001	G-3091	G-3087	G-3211
M-3149	M-3161	M-3196	M-3178	M-3371
G-3021	G-3026	G-3032	G-3089	G-3213
M-3182	M-3156	M-3162	M-3194	M-3372
G-3033	G-3024	G-3008	G-3088	G-3213
M-3153	M-3154	M-3163	M-3199	M-3373
G-3035	G-3002	G-3009	G-3038	G-3216
M-3155	M-3165	M-3183	M-3168	M-3376

Name	Model	Size	Color	Price
Self Adhesive Vinyl (Indoor)	SAV-T2001A-T2036A	45cm x 15Y	about 36 kinds of color	\$29.00 / Roll
	SAV-T2001B-T2036B	60cm x 10Y	about 36 kinds of color	\$18.51 / Roll
Self Adhesive Vinyl (Outdoor)	SAV-T2301H-T2336H	106cm x 50Y	about 36 kinds of color	\$149.29 / Roll
Translucent Self Adhesive Vinyl (Outdoor)	SAV-T3001-T3025	120cm x 50Y	about 25 kinds of color	\$188.16 / Roll
Golden Self Adhesive Vinyl (Indoor)	SAV-T3701A-T3703A	50cm x 10M	about 3 kinds of color	\$25.44 / Roll
	SAV-T3701B-T3703B	100cm x 30M	about 3 kinds of color	\$169.65 / Roll
Fluorescence Self Adhesive Vinyl (Outdoor)	SAV-T3601-T3603	100cm x 30M	about 3 kinds of color	\$138.8 / Roll
Self Adhesive Vinyl (Indoor)	SAV-F201-F212	106cm x 45Y	about 12 kinds of color	\$10.03 / Roll
	SAV-F201H-F212H	106cm x 45Y	about 12 kinds of color	\$92.54 / Roll

**Squeegees** are ideal for eliminating bubbles and smoothing the surface on films, vinyl, graphics, sticker, wallpaper, etc. They can be used on Car explosion-proof membrane and household adornment too.

Their rigid material the edge stays smooth and clean too when you slide the Squeegees on vinyl or other materials.



Name	OK Squeegee	3H Squeegee	3M Squeegee
Code	BS-3000690	BS-3000693	BS-3000692
Made of Materials	Plastic	Plastic	ABS
Size	6.7cm x 9.8cm (2.6" x 3.9")	8.5cm x 12.5cm (3.3" x 4.9")	10cm x 7.1cm (3.9" x 2.8")
Packing Quantity / ctn	1000pcs	50pcs	25pcs
Packaging Dimension	21cm x 25cm x 10cm (8.3" x 9.8" x 3.9")	13.5cm x 9cm x 12cm (5.3" x 3.5" x 4.7")	13.5cm x 9cm x 12cm (5.3" x 3.5" x 4.7")
<b>Unit Price</b>	<b>\$0.83 / pc</b>	<b>\$2.99 / pc</b>	<b>\$4.98 / pc</b>
MOQ	1pcs	1pcs	1pcs

**About Price:** The price of this product list on this book is the third ladder price. You can visit our website [www.sign-in-china.com](http://www.sign-in-china.com) for reference.



### Stand - off Series

- Aluminum alloy material
- Full range of specifications
- Convenient and durable
- Kinds of colors, such as golden, silver anodized, stainless anodized, green, purple, blue, black, etc
- Available for fixing crystal light box, crystal handicraft, glass wares, etc

### Stand - off specification instructions

#### Example



**Model:** CS-AN-12.5-13

**Size:**  $\varnothing$  12.5 x 13mm

**Material:** Aluminum Alloy

**Price:**  $\leq$  \$0.67 / pc



#### $\varnothing$ 12.5 (diameter)



**Model:** CS-AN-12.5-13

**Size:**  $\varnothing$  12.5 x 13mm

**Material:** Aluminum Alloy

**MOQ:** 100pcs

**Price:**  $\leq$  \$0.67 / pc



**Model:** CS-AN-12.5-19

**Size:**  $\varnothing$  12.5 x 19mm

**Material:** Aluminum Alloy

**MOQ:** 100pcs

**Price:**  $\leq$  \$0.77 / pc



**Model:** CS-AN-12.5-25

**Size:**  $\varnothing$  12.5 x 25mm

**Material:** Aluminum Alloy

**MOQ:** 100pcs

**Price:**  $\leq$  \$0.84 / pc

#### $\varnothing$ 16 (diameter)



**Model:** CS-AN-16-13

**Size:**  $\varnothing$  16 x 13mm

**Material:** Aluminum Alloy

**MOQ:** 100pcs

**Price:**  $\leq$  \$0.74 / pc



**Model:** CS-AN-16-19

**Size:**  $\varnothing$  16 x 19mm

**Material:** Aluminum Alloy

**MOQ:** 100pcs

**Price:**  $\leq$  \$0.84 / pc



**Model:** CS-AN-16-25

**Size:**  $\varnothing$  16 x 25mm

**Material:** Aluminum Alloy

**MOQ:** 100pcs

**Price:**  $\leq$  \$0.94 / pc

#### $\varnothing$ 19 (diameter)



**Model:** CS-AN-19-13

**Size:**  $\varnothing$  19 x 13mm

**Material:** Aluminum Alloy

**MOQ:** 100pcs

**Price:**  $\leq$  \$0.94 / pc



**Model:** CS-AN-19-19

**Size:**  $\varnothing$  19 x 19mm

**Material:** Aluminum Alloy

**MOQ:** 100pcs

**Price:**  $\leq$  \$1.01 / pc



**Model:** CS-AN-19-25

**Size:**  $\varnothing$  19 x 25mm

**Material:** Aluminum Alloy

**MOQ:** 100pcs

**Price:**  $\leq$  \$1.10 / pc

#### $\varnothing$ 8 (diameter)



**Model:** CS-AN-8-74

**Size:**  $\varnothing$  8 x 74mm

**Material:** Aluminum Alloy

**MOQ:** 100pcs

**Price:**  $\leq$  \$0.68 / pc



**Model:** CS-AN-8-100

**Size:**  $\varnothing$  8 x 100mm

**Material:** Aluminum Alloy

**MOQ:** 100pcs

**Price:**  $\leq$  \$0.78 / pc

### Glue

Refer to the content on page 182 - 183

## &gt; Engraving Supplies &gt; Cutting mat &amp; craft knives

**SIC-CM-JWX-5LB: B Level 5 - Layer Cutting Craft Mat**

- Comes with marking grids for accurate cutting
- Non - slip surface - for cutting paper, card and other materials
- High quality self - healing Cutting Mat (Cutting Pad) provides a self-healing, non - slip and non - marring cutting surface with inch or cm grid lines
- Impervious to cuts, abrasions and liquid spills
- Preprinted different guidelines on double sides ensure accurate, measured cutting
- The mats are made to be incredibly durable, being capable of withstanding very sharp crafts blades
- **Material:** PVC

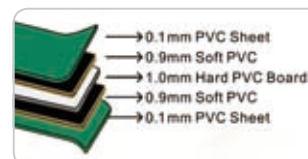
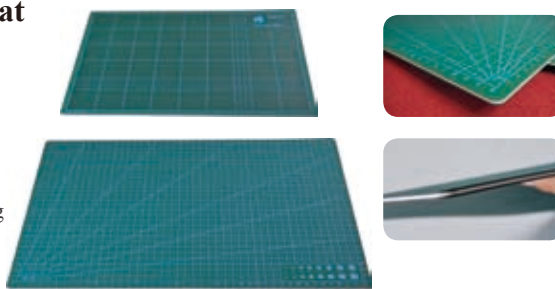
**▼ Specifications**

Model	SIC-CM-JWX-5LB-A1	SIC-CM-JWX-5LB-A2	SIC-CM-JWX-5LB-A3	SIC-CM-JWX-5LB-A4
Size	60cm x 90cm (24" x 35")	45cm x 60cm (18" x 24")	30cm x 45cm (12" x 18")	22cm x 30cm (8.6" x 12")
<b>Price</b>	≤ \$16.10 / pc	≤ \$11.4 / pc	≤ \$6.45 / pc	≤ \$3.14 / pc

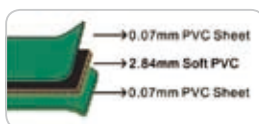
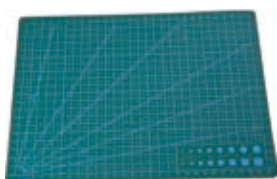
**SIC-CM-JWX-3LC: C Level 3 - Layer Cutting Craft Mat**

- Comes with marking grids for accurate cutting
- Non - slip surface - for cutting paper, card and other materials
- High quality self - healing Cutting Mat (Cutting Pad) provides a self - healing, non - slip and non - marring cutting surface with inch or cm grid lines
- Impervious to cuts, abrasions and liquid spills
- Preprinted different guidelines on double sides ensure accurate, measured cutting
- **Material:** PVC

**▼ Specifications**

Model	SIC-CM-JWX-3LC-A1	SIC-CM-JWX-3LC-A2	SIC-CM-JWX-3LC-A3	SIC-CM-JWX-3LC-A4
Size	60cm x 90cm (24" x 35")	45cm x 60cm (18" x 24")	30cm x 45cm (12" x 18")	22cm x 30cm (8.6" x 12")
<b>Price</b>	≤ \$15.70 / pc	≤ \$7.90 / pc	≤ \$4.30 / pc	≤ \$2.64 / pc

**SIC-CM-JWX-3LA: A Level 3 - Layer Cutting Craft Mat**

- Comes with marking grids for accurate cutting
- Non - slip surface - for cutting paper, card and other materials
- High quality self - healing Cutting Mat (Cutting Pad) provides a self - healing, non - slip and non - marring cutting surface with inch or cm grid lines
- Impervious to cuts, abrasions and liquid spills
- Preprinted different guidelines on double sides ensure accurate, measured cutting
- **Material:** PVC

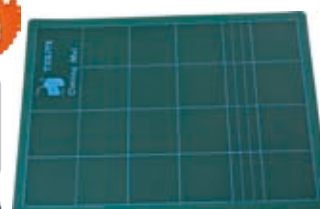
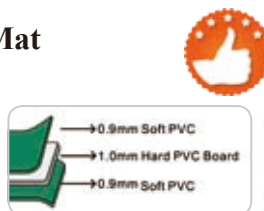
**▼ Specifications**

Model	SIC-CM-JWX-3LA-A1	SIC-CM-JWX-3LA-A2	SIC-CM-JWX-3LA-A3	SIC-CM-JWX-3LA-A4
Size	60cm x 90cm (24" x 35")	45cm x 60cm (18" x 24")	30cm x 45cm (12" x 18")	22cm x 30cm (8.6" x 12")
<b>Price</b>	≤ \$15.90 / pc	≤ \$9.20 / pc	≤ \$5.29 / pc	≤ \$2.81 / pc

**SIC-CM-CP: Cutting Mat for Vinyl Cutters**

- To avoid the paper moving during work, it's better to use the cutting mat when cut normal paper
- It can be used about 100 times
- Normally, the stickiness will weaken when it was used 20 - 30 times; you'd better use 3M no. 67 glue to spray it in order to prolong its lifespan
- The paper should be sticking on the mat. The paper size should be smaller than the cutting mat
- Great for cutting heat transfer vinyl and a variety of other materials with and without an adhesive backing.

**▼ Specifications**

Model	SIC-CM-CP-A3	SIC-CM-CP-A4
Size	29.7cm x 42cm (11.7" x 16.5")	21cm x 29.7cm (8.2" x 11.7")
<b>Price</b>	≤ \$6.78 / pc	≤ \$4.96 / pc

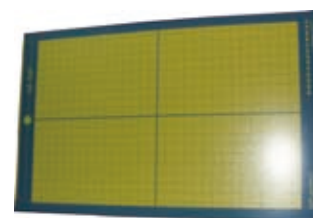

## &gt; Engraving Supplies &gt; Cutting mat &amp; craft knives

**SIC-ZG-MG-001: 21cm Utility Cutter Knife / Craft Knife**

- **Material:** Out covering: Plastic; Blade: Fine steel
- Blade setter with auto - lock function to ensure safe
- **Blade Width:** 18mm

**Price: ≤ \$1.45 / pc****SIC-ZG-MG-002: Economic Plastic Snap off Cutter Knife / Craft Knife**

- **Material:** Out covering: Plastic; Blade: Fine steel
- Blade setter with auto - lock function to ensure safe
- **Blade Width:** 9mm

**Price: ≤ \$0.97 / pc****SIC-ZG-MG-003: Practical 18mm Spare Cutter / Craft Knife Blades**

- **Material:** Stainless steel;
- Designed to give superior cuts on paper, wall paper, plastic, leather, rubber, etc;
- **Package:** 10 pcs in 1 parcel
- **Blade Width:** 18mm

**Price: ≤ \$0.79 / parcel****SIC-ZG-MG-004: Practical 9mm Spare Cutter / Craft Knife Blades**

- **Material:** Stainless steel;
- Designed to give superior cuts on paper, wall paper, plastic, leather, rubber, etc;
- **Package:** 10 pcs in 1 parcel
- **Blade Width:** 9mm

**Price: ≤ \$0.74 / parcel****SIC-ZG-MG-005: High Quality Big Size Tajima Knife Cutters / Craft knives**

- **Material:** Out covering: Plastic; Blade: Fine steel
- Blade setter with auto - lock function to ensure safe
- **Blade Width:** 18mm

**Price: ≤ \$4.13 / pc****SIC-ZG-MG-006: High Quality Small Size Tajima Knife Cutters / Craft Knives**

- **Material:** Out covering: Plastic; Blade: Fine steel
- Blade setter with auto - lock function to ensure safe
- **Blade Width:** 9mm

**Price: ≤ \$3.12 / pc****SIC-ZG-MG-007: Utility - type Auto - retractable Cutter Knife / Craft Knife**

- **Material:** Out covering: Plastic; Blade: Fine steel
- Blade setter with auto - lock function to ensure safe
- **Blade Width:** 18mm

**Price: ≤ \$1.98 / pc****SIC-ZG-MG-008: SK5 High Grade Hook Knife / Craft Knife**

- **Material:** Out covering: Plastic; Blade: Fine steel
- Blade setter with auto - lock function to ensure safe

**Price: ≤ \$4.13 / pc****SIC-ZG-MG-009: Economic Japanese Steel Hook blade Fixed Utility Knife**

- **Material:** Out covering: Plastic; Blade: Fine steel
- Blade setter with auto - lock function to ensure safe

**Price: ≤ \$5.95 / pc****SIC-ZG-MG-010: Acrylic Plastic Cutter Extremely Sharpe for Perspex Made in Japan TAJIMA NEW**

- **Material:** Out covering: Plastic; Blade: Fine steel
- Blade setter with auto - lock function to ensure safe
- Safety lock system achieves more safe application and low fatigue in use

**Price: ≤ \$8.10 / pc****SIC-ZG-MG-011: Plexiglass Knife Blades Made in Japan TAJIMA**

- **Material:** Stainless steel
- Sharp and durable: Easy to cut and has a long life service
- Protected from the air with rust - preventing oil
- **Package:** 5 pcs in 1 parcel

**Price: ≤ \$4.13 / parcel****SIC-ZG-MG-012: High Quality Hook Blades for SK5 Hook Knife**

- **Material:** High carbon steel
- Sharp and durable: easy to cut and has a long life service.
- Protected from the air with rust - preventing oil.
- **Package:** 5pcs in 1 parcel.

**Price: ≤ \$2.50 / parcel**



## > Engraving Supplies > Advertising protectional ruler

### CS-PR-HL Series Advertising Protectional Ruler

- Anti side slipping design to protect your hands
- Aluminum ruler that is strong and durable
- Groove design to avoid cutting askew
- Ruler work together with x - acto knife
- Used for cutting paper, photo paper, Flex Banner, canvas, etc



#### ▼ Specifications

Model	CS-PR-HL-001	CS-PR-HL-002	CS-PR-HL-003	CS-PR-HL-004	CS-PR-HL-005	CS-PR-HL-006
Size	700mm (27.5")	1000mm (39")	1300mm (51")	1600mm (63")	1800mm (71")	2000mm (79")
Price	≤ \$10.41 / pc	≤ \$10.91 / pc	≤ \$19.17 / pc	≤ \$20.17 / pc	≤ \$22.31 / pc	≤ \$23.14 / pc

### SIC-ZG-HKJ: Multifunctional Right - angle Aviation Tin Snips Metal Cutters



It can be used for cutting sheet metal, aluminum sheet, aluminum - plastic panels, aluminum - plastic strips, cold rolled iron sheet, wire mesh, leather, copper and plastics etc.

- Blade is made of stainless steel or alloy tools steel
- Compound hinge delivers more force with less effort, and non - slip handle grips reduce fatigue
- With the simple structure and high practicability

Price: ≤ \$6.61 / pc

### CS-GG-MQ-BY: General Manual Adhesive Silicone Gun Caulking Gun

It can be used for glass glue in building, automotives, packaging, business, advertisement and family decoration.

- Made of titanium alloy
- Adopting reinforcement frame, this caulking gun is made by new mould
- The push rod adopts polygonal design
- The handle is designed according to the ergonomic principles

Price: ≤ \$7.44 / pc

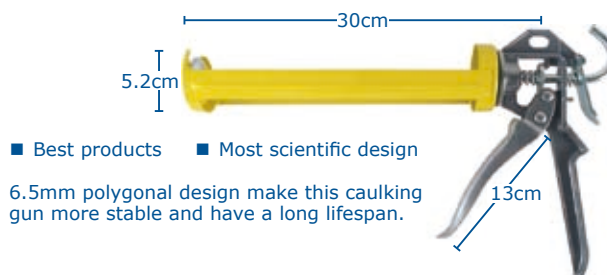

6.5mm polygonal design make this caulking gun more stable and have a long lifespan.

### SIC-ZG-LBQ-001: Stretching Canvas Pliers for Stretching Canvas



It can be used to tighten the Flex Banner to achieve a more perfect effect and the practical type model is more comfortable.

- Quick, easy and safe to use, it is an unique tool
- Made of pure iron
- It can save your fingers and finish your product more quickly and perfectly

Price: ≤ \$9.26 / pc

### CS-GT-ZG-MPS: Heavy-duty U Shape Stainless Steel Staple Gun Tacker

This staple gun is used extensively by building contractors, home DIY'ers and specialty trade applicators for re - covering furniture, decorating, applying fabric to walls or wood, ceiling tile, window screening, upholstery, carpet padding, fence wire, metal lath, cornerite, and many other jobs ranging from light to heavy duty work.

- The end of the magazine can be used to remove the nails
- A nail consumption indicator is designed at the bottom of noise
- Light weight and well balanced for easy operating

Price: ≤ \$13.22 / pc



**ABS Double Color Sheet**

Please refer to the contents on page 358

**Acrylic Board & Sheet**

Please refer to the contents on page 359 - 362

**PVC Foam Board**

Please refer to the content on page 363 - 364

# 03 POP & EXHIBIT DISPLAYS



Price: ≤ \$311 / set  
on P288

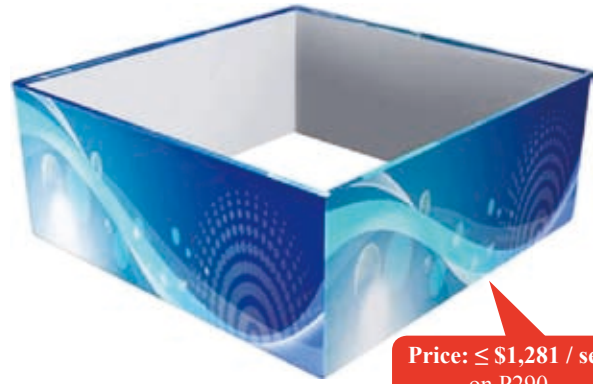

Price: ≤ \$1,281 / set  
on P290



Price: ≤ \$147 / pc  
on P300



Price: ≤ \$92 / pc  
on P301



Price: ≤ \$12.07 / pc  
on P277



Price: ≤ \$119.34 / pc  
on P286



Price: ≤ \$132 / pc  
on P305



Price: ≤ \$166 / pc  
on P305

## P274 | Portable Banner Display

P274 | ECO bamboo banner display

P275 | Display booth stand system

P277 | Roll up banner stand

P280 | Pop up display

P283 | X and L banner stand

P285 | Flag banner stand

P287 | Backpack banner

## P288 | Fabric Tension Display

## P291 | Poster Display Stand

## P292 | Brochure Stand

## P293 | Portable Trade Show Counters

## P296 | Sign Holder

## P298 | Store Display Rack

## P299 | Display Light Box

P299 | Slim LED light box

P303 | Acrylic crystal light box

P305 | Magic light box

P307 | Rotating & scrolling light box

## P311 | LCD Advertising Player

> Portable Banner Display > ECO bamboo banner display



## Elliptical Bamboo Roll Up Display

Item No: SIC-RU-EB

G.W. / pc: 3.2kg (7lb)

Normal Graphic Size (W x H): 85cm x 200cm (33" x 79")

Package: Double canvas bags

Package Size / ctn: 99cm x 78cm x 32cm (39" x 31" x 13") / 6pcs

G.W. / ctn: 19.5kg (43lb)

Price: ≤ \$86.78 / pc



## Deluxe Bamboo Banner Stands

Item No: SIC-S-BP

G.W. / pc: 3.1kg (7lb)

Normal Graphic Size (W x H): 60cm x 180cm (24" x 71")

Package: Double canvas bags

Package Size / ctn: 76cm x 36cm x 15cm (30" x 14" x 6") / 2pcs

G.W. / ctn: 7.2kg (16lb)

Price: ≤ \$59.01 / pc

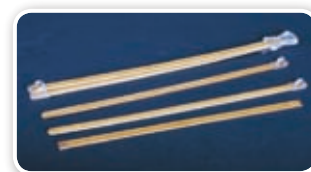

## Bamboo X Banner Stands

Item No: SIC-S-B X A

G.W. / pc: 0.84kg (2lb)

Normal Graphic Size (W x H): 60cm x 180cm (24" x 71")

Package: Single canvas bag

Package Size / ctn: 108cm x 40cm x 26cm (43" x 16" x 10") / 25pcs

G.W. / ctn: 21.8kg (48lb)

Price: ≤ \$21.16 / pc

> Portable Banner Display > Display booth stand system



## 8ft x 8ft Display Booth Stand

**Item No:** BR50S-A

**Material:** Aluminum alloy

**Product Size:** 250cm x 250cm x 38cm (99" x 99" x 15")

**Normal Graphic Size (W x H):** 250cm x 250cm (99" x 99")

**N.W.:** 28kg (62lb)

**Packing (L x W x H):** 14cm x 172cm x 41cm (6" x 68" x 16") / 1pc

**G.W.:** 31kg (68lb)

**Price:** ≤ \$595 / pc

## 10ft x 10ft Fast Exhibition Trade Show Display

**Item No:** FS-EX33001

**Material:** Aluminum alloy

**Product Size:** 300cm x 258cm x 59cm (118" x 102" x 23")

**Normal Graphic Size (W x H):** 222cm x 212cm (87" x 84")

**Packing (L x W x H):** 142cm x 74cm x 35cm (56" x 29" x 14") / 1pc

**G.W.:** 81kg (178lb)

**Price:** ≤ \$2,923 / pc



## 10ft x 20ft Fast Exhibition Trade Show Display

**Item No:** FS-EX36001

**Material:** Aluminum alloy

**Product Size:** 600cm x 258cm x 59cm (236" x 102" x 23")

**Normal Graphic Size (W x H):** 444cm x 212cm (178" x 84")

**Packing (L x W x H):** 142cm x 74cm x 35cm (56" x 29" x 14") / 1pc

**G.W.:** 117kg (257lb)

**Price:** ≤ \$4,442 / pc

## 10ft x 10ft Fast Exhibition Display Booth

**Item No:** FS-EX33002

**Material:** Aluminum alloy

**Product Size:** 300cm x 241cm x 41cm (118" x 95" x 16")

**Normal Graphic Size (W x H):** Main graphic: 182cm x 187cm (71" x 74")

Header: 182cm x 40cm (71" x 16")

**Packing (L x W x H):** 142cm x 74cm x 35cm (56" x 29" x 14") / 1pc

**G.W.:** 96kg (211lb)

**Price:** ≤ \$3,611 / pc



## 10ft x 10ft Special Exhibition Display Booth

**Item No:** FS-EX33004

**Material:** Aluminum alloy

**Product Size:** 328cm x 263cm x 141cm (129" x 104" x 56")

**Normal Graphic Size (W x H):**

Main graphic: 228cm x 187cm (90" x 74")

Header: 212cm x 40cm (84" x 16")

Side graphic: 68cm x 191cm (27" x 75")

Upper left graphic 1: 68cm x 32cm (27" x 13")

Upper left graphic 2: 233cm x 25cm (92" x 10")

**Packing (L x W x H):** 142cm x 74cm x 35cm (56" x 29" x 14") / 1pc

**G.W.:** 68kg (150lb)

**Price:** ≤ \$3,123 / pc

## 10ft x 10ft Inline Exhibition Display Booth

**Item No:** FS-EX33005

**Material:** Aluminum alloy

**Product Size:** 300cm x 241cm x 65cm (118" x 95" x 26")

**Normal Graphic Size (W x H):** Main graphic: 228cm x 212cm (90" x 84")

Header: 228cm x 43cm (90" x 17")

**Packing (L x W x H):** 142cm x 74cm x 35cm (56" x 29" x 14") / 1pc

**G.W.:** 91kg (200lb)

**Price:** ≤ \$3,067 / pc



> Portable Banner Display > Roll up banner stand



**Economy Standard Roll up Banner Stand**

**Item No:** DH-R-SIC-10

**Material:** Aluminum

**N.W.:** 2.3kg (5lb)

**Normal Graphic Size (W x H):** 85cm x 200cm  
(33" x 79")

**Packing:** 63cm x 43cm x 91cm (25" x 17" x 36") / 12pcs,  
29.8kg (66lb)

**Price:** ≤ \$12.07 / pc



Economical



**Adjustable Roll up Banner Stand**

**Item No:** YLB-S-YL-C80A

**Material:** Aluminum

**N.W.:** 3.3kg (7lb)

**Normal Graphic Size (W x H):** 85cm x 200cm  
(33" x 79")

**Packing:** 38cm x 27cm x 91cm (15" x 11" x 36") / 6pcs,  
23.6kg (52lb)

**Price:** ≤ \$29.42 / pc



**Broad Base Roll up Banner Stand**

**Item No:** YLB-SKL1-6

**Material:** Aluminum

**N.W.:** 5.1kg (11lb)

**Normal Graphic Size (W x H):** 85cm x 200cm (33" x 79")

**Packing:** 46cm x 24cm x 93cm  
(18" x 9" x 37") / 4pcs,  
24.8kg (55lb)

**Price:** ≤ \$41.66 / pc

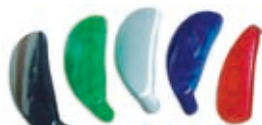

**Multi-Feature Roll up Banner Stand**

**Item No:** DH-R-SIC-04

**Material:** Aluminum

**N.W.:** 5.3kg (12lb)

**Normal Graphic Size (W x H):** 85cm x 200cm (33" x 79")

**Packing:** 30cm x 53cm x 98cm  
(12" x 21" x 39") / 4pcs,  
28.3kg (62lb)

**Price:** ≤ \$60 / pc



> Portable Banner Display > Roll up banner stand

**Elliptical Base Good Quality Roll Up Banner Stand**

**Item No:** SIC-RU-E  
**Material:** Aluminum  
**N.W.:** 3.3kg (7.3lb)  
**Normal Graphic Size (W x H):** 85cm x 200cm (33" x 79")  
**Packing:** 13cm x 18cm x 92cm (5" x 7" x 36") / 1pc, 3.8kg (8lb)  
**Price: ≤ \$57.19 / pc**

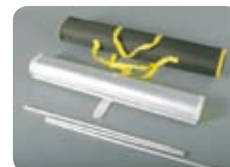

**Heavy Base Roll up Banner Stand**

**Item No:** DH-R-S-1E  
**Material:** Aluminum  
**N.W.:** 3.8kg (8lb)  
**Normal Graphic Size (W x H):** 85cm x 200cm (33" x 79")  
**Packing:** 32cm x 23cm x 91cm (13" x 9" x 36") / 6pcs, 27.7kg (61lb)  
**Price: ≤ \$34.55 / pc**



**Good Quality Double Sided Roll Up Banner Stand**

**Item No:** DH-R-S-7  
**Material:** Aluminum  
**N.W.:** 5.4kg (12lb)  
**Normal Graphic Size (W x H):** 85cm x 200cm (33" x 79")  
**Packing:** 35cm x 19cm x 93cm (14" x 7" x 37") / 3pcs, 20.8kg (46lb)  
**Price: ≤ \$39.67 / pc**



**Good Quality Standard Roll up Banner Stand**

**Item No:** DH-R-SIC-02  
**Material:** Aluminum  
**N.W.:** 2.8kg (6lb)  
**Normal Graphic Size (W x H):** 85cm x 200cm (33" x 79")  
**Packing:** 32cm x 23cm x 91cm (13" x 9" x 36") / 6pcs, 21.8kg (48lb)  
**Price: ≤ \$19.9 / pc**





> Portable Banner Display > Roll up banner stand

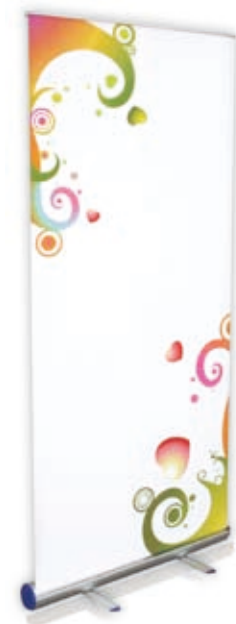

**Economy Round Base Roll up Banner Stand**

**Item No:** SIC-R-S-28  
**Material:** Aluminum  
**N.W.:** 2.3kg (5.1lb)  
**Normal Graphic Size (W x H):** 85cm x 200cm (33" x 79")  
**Packing:** 37cm x 25cm x 93cm (15" x 10" x 36") / 6pcs, 16.4kg (36.1lb)

**Price: ≤ \$16.28 / pc**

**Heart-Shaped Base Roll up Banner Stand**

**Item No:** SIC-R-S-29  
**Material:** Aluminum  
**N.W.:** 2.6kg (5.7lb)  
**Normal Graphic Size (W x H):** 85cm x 200cm (33" x 79")  
**Packing:** 39cm x 27cm x 93cm (15" x 11" x 37") / 6pcs, 22.9kg (50.4lb)

**Price: ≤ \$46.28 / pc**

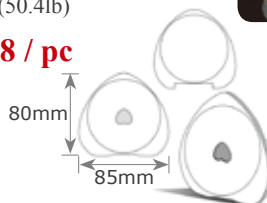
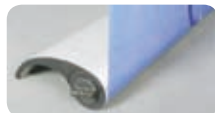
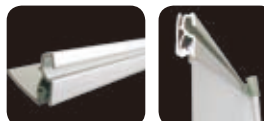

**Dismountable Base Roll up Banner Stand**

**Item No:** SIC-R-S-30  
**Material:** Aluminum  
**N.W.:** 4.8kg (10.6lb)  
**Normal Graphic Size (W x H):** 85cm x 200cm (33" x 79")  
**Packing:** 46cm x 24cm x 93cm (18" x 9" x 37") / 4pcs, 22.7kg (50lb)

**Price: ≤ \$85.31 / pc**

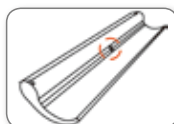

**Super Portable Black Base Roll up Banner Stand**

**Item No:** DH-R-SIC-21  
**Material:** Aluminum  
**N.W.:** 2.3kg (5.1lb)  
**Normal Graphic Size (W x H):** 85cm x 200cm (33" x 79")  
**Packing:** 38cm x 27cm x 93cm (15" x 11" x 37") / 6pcs, 19.6kg (43lb)

**Price: ≤ \$28.76/ pc**

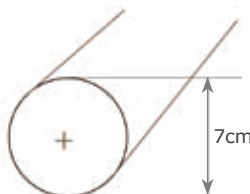

> Portable Banner Display > Pop up display

## 7.5ft Curved Pop Up Display (Frame only) - Magnetic Connections

Item No: SIC-LW-002

Material: Aluminum

Frame Size (W x H): 203cm x 222cm (80" x 87")

Normal Graphic Size (W x H): 359cm x 222cm (141" x 87")

Package Size / ctn: 72cm x 42cm x 100cm (28" x 17" x 39")

G.W. / ctn: 35.6kg (78lb)

Price: ≤ \$381 / set

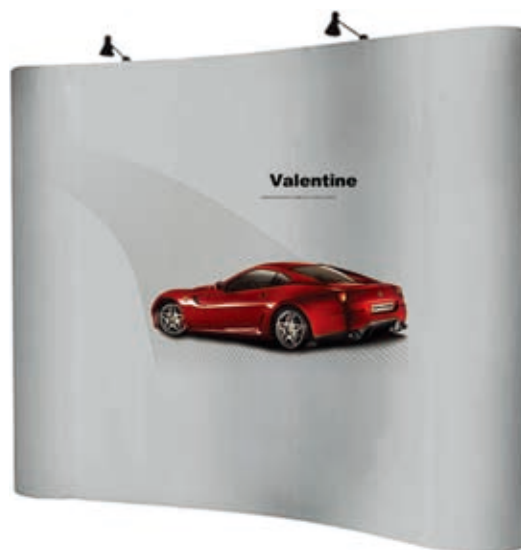

## 7.5ft Straight Pop Up Display (Frame only) - Self-locking Connections

Item No: SIC-DH-RPU-3 x 3L

Material: Aluminum

Frame Size (W x H): 219cm x 222cm (86" x 87")

Normal Graphic Size (W x H): 219cm x 222cm (86" x 87")

Package Size / ctn: 72cm x 42cm x 100cm (28" x 17" x 39")

G.W. / ctn: 36.4kg (80lb)

Price: ≤ \$388 / set



> Portable Banner Display > Pop up display

## 10ft Curved Pop Up Display (Frame only) - Self - locking Connections

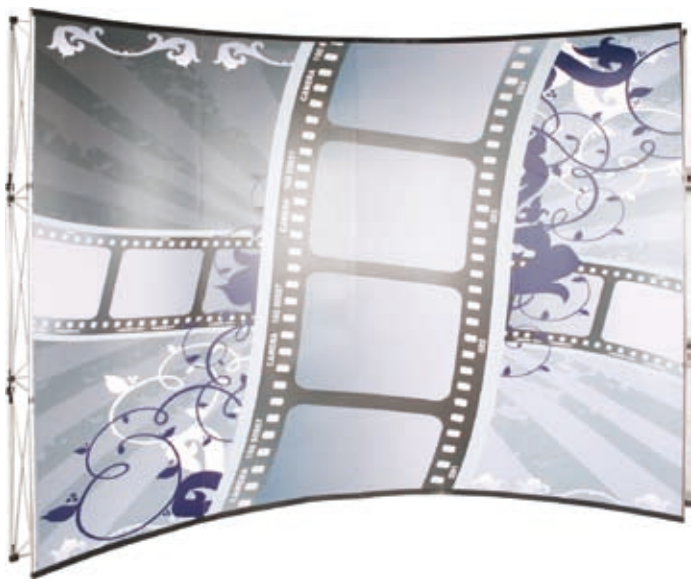

Item No: SIC-DH-RPU-RA / B  
 Material: Aluminum  
 Frame Size (W x H): 299cm x 238cm (118" x 94")  
 Normal Graphic Size (W x H): 399cm x 238cm (157" x 94")  
 Package Size / ctn: 72cm x 42cm x 100cm (28" x 17" x 39")  
 G.W. / ctn: 46.6kg (120lb)

Price: ≤ \$416 / set



## 10ft Curved Pop Up Display (Frame only) - Spring Connections

Item No: PUD-S-LW-A-1  
 Material: Aluminum  
 Frame Size (W x H): 290cm x 230cm (114" x 91")  
 Normal Graphic Size (W x H): 414cm x 230cm (163" x 91")  
 Package Size / ctn: 72cm x 42cm x 100cm (28" x 17" x 39")  
 G.W. / ctn: 37.7kg (83lb)

Price: ≤ \$259.17 / set



> Portable Banner Display > Pop up display

## 7.5ft Straight Velcro Pop Up Display (Frame only) - Hook Connections

**Item No:** PUD-LW-5

**Material:** Aluminum

**Frame Size (W x H):** 226.5cm x 226.5cm (89" x 89")

**Normal Graphic Size (W x H):** 226.5cm x 226.5cm (89" x 89")

**Package Size / ctn:** 45cm x 45cm x 90cm (18" x 18" x 35")

**G.W. / ctn:** 13.6kg (30lb)

**Price:** ≤ \$216.68 / set



## Pop Up Tower (Frame only) - Magnetic Connections

**Item No:** SIC-PU-T

**Material:** Aluminum

**Frame Size:** 222cm H x 64.4cm, Diameter (87" H x 25" D)

**Normal Graphic Size (W x H):** 202cm x 222cm (80" x 87")

**Package Size / ctn:** 50cm x 50cm x 91cm (18" x 18" x 36")

**G.W. / ctn:** 19kg (42lb)

**Price:** ≤ \$140.99 / set



> Portable Banner Display > X and L banner stand

**Classic Adjustable Size X Banner Stand**

**Item No:** XBS-X2B-80180  
**Material:** Carbon Fiber, Aluminum, Plastic  
**Graphic Size (W x H):** 60cm x 160cm - 80cm x 180cm  
 (24" x 63" - 32" x 71")  
**Package / pc:** Single canvas bag  
**Package Size / ctn:** 28cm x 50cm x 105cm  
 (11" x 20" x 41") / 10pcs  
**G.W. / ctn:** 11.6kg (26lb)

**Price: ≤ \$13.64 / pc**



**Economy Iron Foot X Banner Stand**

**Item No:** SIC-X-C1-60160  
**Material:** Carbon Fiber, Iron, Plastic  
**Graphic Size (W x H):** 60cm x 160cm (24" x 63")  
**Package / pc:** Single canvas bag  
**Package Size / ctn:** 32cm x 43cm x 108cm  
 (13" x 17" x 43") / 10pcs  
**G.W. / ctn:** 17.9kg (39lb)

**Price: ≤ \$6.2 / pc**



**Round Bar Classic X Banner Stand**

**Item No:** SIC-X-S-X3-60160  
**Material:** Carbon Fiber, Plastic  
**Graphic Size (W x H):** 60cm x 160cm (24" x 63")  
**Package / pc:** Single canvas bag  
**Package Size / ctn:** 25cm x 42cm x 106cm (10" x 17" x 42") / 25pcs  
**G.W. / ctn:** 14.5kg (32lb)

**Price: ≤ \$4.79 / pc**



**Good Quality Carbon Fiber X Banner Stand**

**Item No:** GF-2F-60160  
**Material:** Carbon Fiber  
**Graphic Size (W x H):** 60cm x 160cm (24" x 63")  
**Package / pc:** Single canvas bag  
**Package Size / ctn:** 46cm x 19cm x 115cm (18" x 7" x 45") / 20pcs  
**G.W. / ctn:** 11.2kg (25lb)

**Price: ≤ \$7.19 / pc**



> Portable Banner Display > X and L banner stand

**Adjustable X Banner (Adjustable Width & Height)**

**Item No:** SIC-X-S-X7-01  
**Material:** Carbon Fiber, Aluminum, Plastic  
**Graphic Size (W x H):** 50cm x 160cm - 60cm x 180cm  
 (20" x 63" - 24" x 71")  
**Package / pc:** Single canvas bag  
**Package Size / ctn:** 100cm x 45cm x 32cm  
 (39" x 18" x 13") / 15pcs  
**G.W. / ctn:** 20.4kg (45lb)

**Price: ≤ \$16.86 / pc**



**Deluxe X Banner Stand**

**Item No:** SIC-X-E1-60180  
**Material:** Aluminum  
**Graphic Size (W x H):** 60cm x 180cm (24" x 71")  
**Package / pc:** Leathery bag  
**Package Size / ctn:** 20cm x 63cm x 125cm (8" x 25" x 49") / 5pcs  
**G.W. / ctn:** 21.5kg (47lb)

**Price: ≤ \$73.88 / pc**

**Iron Base Adjustable L Banner Stand**

**Item No:** LBS-S-LA-C  
**Material:** Aluminum, Plastic, Iron  
**Graphic Size (W x H):** 90cm x 100cm - 90cm x 210cm  
 (35" x 39" - 35" x 83")  
**Package / pc:** Single canvas bag  
**Package Size / ctn:** 23cm x 17cm x 105cm  
 (9" x 7" x 41") / 10pcs  
**G.W. / ctn:** 18.8kg (41lb)

**Price: ≤ \$17.52 / pc**

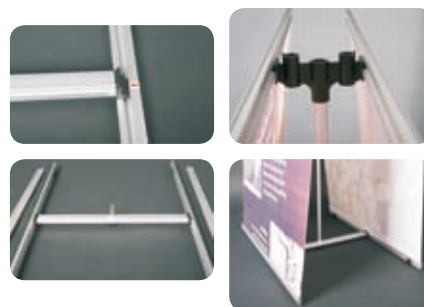

**Double Sided L Banner Stand**

**Item No:** SIC-L-C-D  
**Material:** Aluminum  
**Graphic Size (W x H):** 90cm x 215cm  
 (35" x 85")  
**Package / pc:** Double canvas bag  
**Package Size / ctn:** 35cm x 25cm x 103cm (14" x 10" x 41") / 6pcs  
**G.W. / ctn:** 19.6kg (43lb)

**Price: ≤ \$36.1/ pc**

> Portable Banner Display > Flag banner stand

### 9.8 ft Teardrop Banner with Spike Base

**Item No:** SIC-FB-ST-2  
**Material:** Pole: Aluminum, Carbon;  
 Base: Steel  
**Banner Size (W x H):** 90cm x 240cm (35" x 95")  
**Pole Height (with flag):** 3m (118")  
**Package Size / ctn:** 16cm x 23cm x 126cm  
 (6" x 9" x 50") / 5pcs  
**G.W. / ctn:** 26.8kg (59lb)

**Price: ≤ \$74.38 / pc**

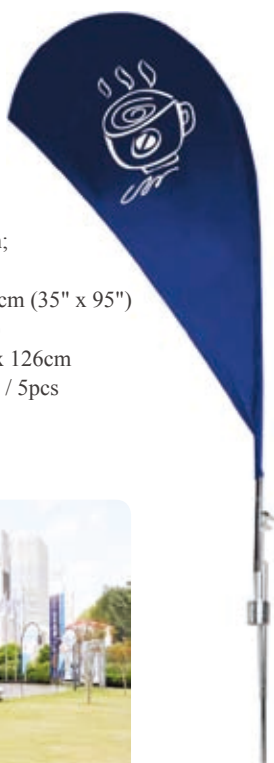

### 11.5 ft Wing Banner with Spike Base

**Item No:** SIC-FB-SWING-2  
**Material:** Pole: Aluminum, Carbon;  
 Base: Steel  
**Banner Size (W x H):** 90cm x 285cm (35" x 112")  
**Pole Height (with flag):** 3.5m (138")  
**Package Size / ctn:** 16cm x 23cm x 126cm  
 (6" x 9" x 50") / 5pcs  
**G.W. / ctn:** 26.8kg (59lb)

**Price: ≤ \$82.98 / pc**



### 13.1 ft Pole with Spike Base

**Item No:** SIC-FB-S-2  
**Material:** Pole: Aluminum, Carbon;  
 Base: Steel  
**Pole Height (without flag):** 4m (158")  
**Package Size / ctn:** 16cm x 23cm x 126cm (6" x 9" x 50") / 5pcs  
**G.W. / ctn:** 25kg (55lb)

**Price: ≤ \$33.55 / pc**



### Banner Pole with Dual Suction Cup System

**Item No:** WBS-S-CC-D  
**Material:** Pole: Aluminum, Plastic  
**Banner Size (W x H):** 50cm x 125cm (20" x 49")  
**Package Size / ctn:** 57cm x 23cm x 80cm (22" x 9" x 32") / 10pcs  
**G.W. / ctn:** 8.4kg (19lb)

**Price: ≤ \$11.4 / pc**



## &gt; Portable Banner Display &gt; Flag banner stand

**13.1 ft Wing Banner with Cross Water Bag Base****Item No:** SIC-FB-CWW-3**Material:** Pole: Aluminum, Carbon;

Base: Steel

**Banner Size (W x H):** 90cm x 330cm (35" x 130")**Pole Height (with flag):** 4m (158")**Package Size / ctn:** 16cm x 23cm x 146cm

(6" x 9" x 58") / 5pcs

**G.W. / ctn:** 37.5kg (83lb)**Price: ≤ \$107.44 / pc****11.5 ft Teardrop Banner with Cross Water Bag Base****Item No:** SIC-FB-CWT-3**Material:** Pole: Aluminum, Carbon;

Base: Steel

**Banner Size (W x H):** 120cm x 300cm (47" x 118")**Pole Height (with flag):** 3.5m (138")**Package Size / ctn:** 16cm x 23cm x 146cm (6" x 9" x 58") / 5pcs**G.W. / ctn:** 37.5kg (83lb)**Price: ≤ \$119.34 / pc****15 ft Pole with Cross Base and Water Bag****Item No:** SIC-FB-CW-3**Material:** Pole: Aluminum, Carbon;

Base: Steel

**Pole Height (without flag):** 4.5m (177")**Package Size / ctn:** 16cm x 23cm x 146cm (6" x 9" x 58") / 5pcs**G.W. / ctn:** 35kg (77lb)**Price: ≤ \$50.91 / pc****Outdoor 5M Flag Banner (Stand only)****Item No:** OFS-HW-3**Material:** Aluminum, Plastic**Banner Size (W x H):** 100cm x 350cm (39" x 138")**Pole Height (without flag):** 5m (197")**Package Size / ctn:** 21cm x 12cm x 172cm,

86cm x 42cm x 42cm

(8" x 5" x 68", 34" x 17" x 17")

**G.W. / ctn:** 32kg (70lb)**Price: ≤ \$246.2 / pc**



> Portable Banner Display > Backpack banner



### THE INSTALLING DRAWING OF KNAPSACK FLAG BANNER

Unscrew the expansion bend to adjust the height of flag pole and thrust the fiber post, then set the fixing loop of rubber.

## Backpack L Banner Stand

Item No: KS-S-BB-B

Graphic Size (W x H): 40cm x 125cm (16" x 49")

N.W. / pc: 1.5kg (3.3lb)

Package Size (L x W x H): 70cm x 35cm x 40cm  
(28" x 14" x 16") / 5pcs

G.W. / ctn: 9.5kg (21lb)

Price: ≤ \$54.55 / pc



## Backpack X Banner Stand

Item No: KS-S-BB-C

Graphic Size (W x H): 45cm x 120cm (18" x 47")

N.W. / pc: 1.5kg (3.3lb)

Package Size (L x W x H): 70cm x 35cm x 40cm (28" x 14" x 16") / 5pcs

G.W. / ctn: 9.4kg (21lb)

Price: ≤ \$54.55 / pc



> Fabric Tension Display

**10ft Curved Fabric Display Wall (Graphics Included)**

Item No: SIC-EDF-C-43  
 Material: Aluminum  
 Frame Size (W x L): 300cm x 221cm (118" x 87")  
 Graphic Size (W x L): 314cm x 230cm (124" x 91")  
 Package Size: 80cm x 35cm x 25cm (32" x 14" x 10")  
 G.W. / set: 8kg (18lb)

Price: ≤ \$311 / set



**10ft Straight Fabric Display Wall (Graphics Included)**

Item No: SIC-EDF-St-43  
 Material: Aluminum  
 Frame Size (W x L): 295cm x 221cm (116" x 87")  
 Graphic Size (W x L): 295cm x 228cm (116" x 90")  
 Package Size: 80cm x 35cm x 25cm (32" x 14" x 10")  
 G.W. / set: 7.5kg (17lb)

Price: ≤ \$311 / set



**20ft S Shape Fabric Display Wall (Graphics Included)**

Item No: SIC-EDF-S-73  
 Material: Aluminum  
 Frame Size (W x L): 598cm x 221cm (236" x 87")  
 Graphic Size (W x L): 640cm x 230cm (252" x 91")  
 Package Size: 80cm x 35cm x 45cm (32" x 14" x 18")  
 G.W. / set: 13.5kg (30lb)

Price: ≤ \$537 / set



**U Shape Fabric Display Wall (Graphics Included)**

Item No: SIC-EDF-U-01  
 Material: Aluminum  
 Frame Size (W x L): 275cm x 226cm (108" x 89")  
 Graphic Size (W x L): 278cm x 230cm (110" x 91")  
 Package Size: 80cm x 35cm x 25cm (32" x 14" x 10")  
 G.W. / set: 7kg (15lb)

Price: ≤ \$386 / set

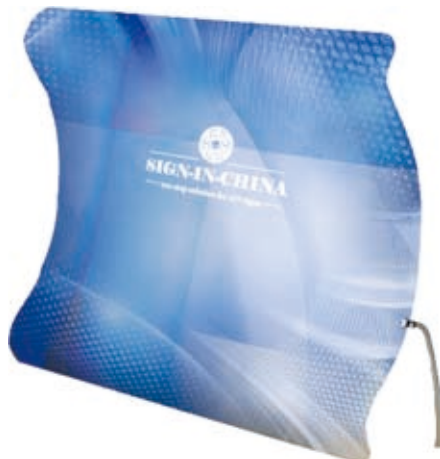

> Fabric Tension Display



**Dye - Sub Fabric Counter (Graphics Included)**

**Item No:** SIC-EDF-FC-01  
**Material:** Aluminum, MDF  
**Frame Size:** Φ60cm x 97cm H (Φ24"x 38")  
**Graphic Size (W x H):** 148cm x 100cm (58" x 39")  
**Package Size:** 20cm x 35cm x 55cm (8" x 14" x 22")  
**G.W. / set:** 5.5kg (12lb)

**Price: ≤ \$106.36 / set**



**Allure Fabric Tension Banner Stands - Arc angle (Graphics Included)**

**Item No:** SIC-EDF-LDB-01  
**Material:** Aluminum, MDF  
**Frame Size:** Φ85cm x 200cm H (Φ33" x 79")  
**Graphic Size (W x H):** 88cm x 200cm (35" x 79")  
**Package Size:** 15cm x 35cm x 55cm (6" x 14" x 22")  
**G.W. / set:** 4kg (9lb)

**Price: ≤ \$139.67 / set**



**Allure Fabric Tension Banner Stands - Oblique angle (Graphics Included)**

**Item No:** SIC-EDF-LDB-02  
**Material:** Aluminum, MDF  
**Frame Size:** Φ85cm x 200cm H (Φ33" x 79")  
**Graphic Size (W x H):** 88cm x 206cm (35" x 81")  
**Package Size:** 15cm x 35cm x 55cm (6" x 14" x 22")  
**G.W. / set:** 4kg (9lb)

**Price: ≤ \$139.67 / set**



**S Curved Fabric Tension Display**

**Item No:** SIC-EDF-SC-1  
**Material:** Aluminum  
**Frame Size (W x H):** 98cm x 200cm (38.6" x 78.8")  
**Graphic Size (W x H):** 105cm x 245cm (41.4" x 96.5")  
**Package Size:** 100cm x 40cm x 30cm (39.4" x 15.8" x 11.8")  
**G.W. / set:** 5kg (11lb)

**Price: ≤ \$330 / set**



## &gt; Fabric Tension Display

**20ft Circle Fabric Tension Display Hanging Sign**

Item No: SIC-FHS-C-20

Material: Aluminum

Graphic Size:  $\Phi 609.6\text{cm} \times 121.9\text{cm}$  ( $\Phi 240'' \times 48''$ )Package Size: 35cm x 25cm x 202cm  
(13.8" x 9.9" x 79.6")

G.W. / set: 35.8kg (78.8lb)

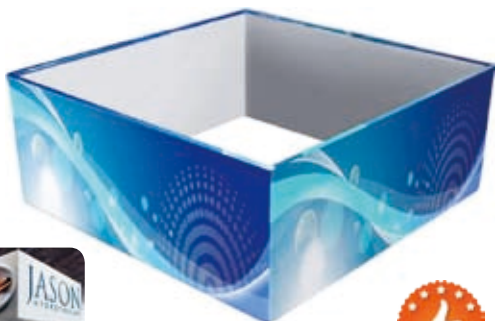
Price: **≤ \$1,015 / set****16ft Square Fabric Tension Display Hanging Sign**

Item No: SIC-FHS-S-16

Material: Aluminum

Graphic Size (L x H): 487.7cm x 121.9cm x 4 (192.2" x 48" x 4)

Package Size: 40cm x 25cm x 172cm (15.8" x 9.9" x 67.8")

G.W. / set: 35kg (77lb)

Price: **≤ \$1,281 / set****14ft Triangular Fabric Tension Display Hanging Sign**

Item No: SIC-FHS-T-14

Material: Aluminum

Graphic Size (L x H): 426.7cm x 106.7cm x 3  
(168.1" x 42" x 3)Package Size: 40cm x 25cm x 152cm  
(15.8" x 9.9" x 60")

G.W. / set: 27kg (59.4lb)

Price: **≤ \$885 / set****15ft Tapered Circle Fabric Tension Display Hanging Sign**

Item No: SIC-FHS-TC-15

Material: Aluminum

Graphic Size (L x H): 1436cm x 121.9cm  
(565.8" x 48")Package Size: 40cm x 25cm x 152cm  
(15.8" x 9.9" x 60")

G.W. / set: 28kg (61.6lb)

Price: **≤ \$1,057 / set**

> Poster Display Stand

**Three Sided Banner Stand (Stand only)**

Item No: SIC-T-S  
 Material: Aluminum  
 Graphic Size (W x H): 90cm x 215cm (35" x 85")  
 Package Size: 108cm x 15cm x 40cm (43" x 6" x 16") / 5pcs  
 G.W. / ctn: 16.5kg (36lb)

Price: ≤ \$23.14 / pc



**Steel Base Adjustable Poster Banner Stand (Stand only)**

Item No: ALS-S-HB-E  
 Material: Aluminum, Steel  
 Graphic Size (W x H): 60cm x 180cm (23.6" x 70.9")  
 Package Size: 150cm x 40cm x 15cm (59" x 15.8" x 5.9") / 2pcs  
 G.W. / ctn: 15.2kg (33.4lb)

Price: ≤ \$132.4 / pc



**Banner Stand with Cross Base (Stand only)**

Item No: HPS-SKL7-1  
 Material: Aluminum  
 Graphic Size (W x H): 60cm x 160cm (24" x 63")  
 Package Size: 34cm x 24cm x 98cm (13" x 9" x 39") / 10pcs  
 G.W. / ctn: 16kg (35lb)

Price: ≤ \$10.74 / pc



**60cm x 90cm (24" x 35") Single Side Snap Frame Poster Stand (Frame only)**

Item No: SIC-PDS-SPS6  
 Material: Aluminum  
 Graphic Size (W x H): 60cm x 90cm (24" x 35")  
 Package Size: 115cm x 70cm x 35cm (45" x 28" x 14") / 5pcs  
 G.W. / ctn: 26.5kg (58lb)

Price: ≤ \$36.2 / pc



> Brochure Stand

### Portable Acrylic Folding Magazine Holder

**Item No:** DH-B-H4  
**Material:** Steel, Acrylic  
**Height:** 156cm (61")  
**Package / pc:** Double oxford bags  
**Package Size / ctn:** 30cm x 30cm x 47cm  
 (12" x 12" x 19") / 1pc  
**G.W. / ctn:** 6.9kg (15lb)

**Price: ≤ \$70.58 / pc**



### Portable Wooden Folding Magazine Holder

**Item No:** PMS-SKL9-2  
**Material:** Aluminum, Wood  
**Height:** 152cm (60")  
**Package / pc:** Aluminum case  
**Package Size / ctn:** 48cm x 36cm x 18cm  
 (19" x 14" x 7") / 1pc  
**G.W. / ctn:** 10.8kg (24lb)

**Price: ≤ \$75.87 / pc**



### Portable Folding Table with 3 Literature Pockets

**Item No:** PMS-Z4  
**Material:** Steel, Wood  
**Height:** 100cm (39")  
**Package / pc:** Oxford cloth bag  
**Package Size / ctn:** 60cm x 43cm x 35cm (24" x 17" x 14") / 2pcs  
**G.W. / ctn:** 17.3kg (38lb)

**Price: ≤ \$59.34 / pc**



### Catalog Rack with Hard Silver Case

**Item No:** ZL-402  
**Material:** Aluminum, Acrylic  
**Height:** 152cm (60")  
**Package / pc:** Aluminum case  
**Package Size / ctn:** 48cm x 36cm x 18cm  
 (19" x 14" x 7") / 1pc  
**G.W. / ctn:** 11kg (24lb)

**Price: ≤ \$61.98 / pc**



> Portable Trade Show Counters

## Big Size Standard Pop up Counter

**Item No:** SIC-PU-C  
**Material:** Aluminum, Steel, Wood, PVC, Self - adhesive photo paper, Oxford bag  
**Graphic Size (W x H):** 197cm x 95cm (78" x 37")  
**Package Size / ctn:** 103cm x 68cm x 16cm (41" x 27" x 6") / 1pc  
**G.W. / ctn:** 16kg (35lb)  
**Price: ≤ \$104.13 / set**

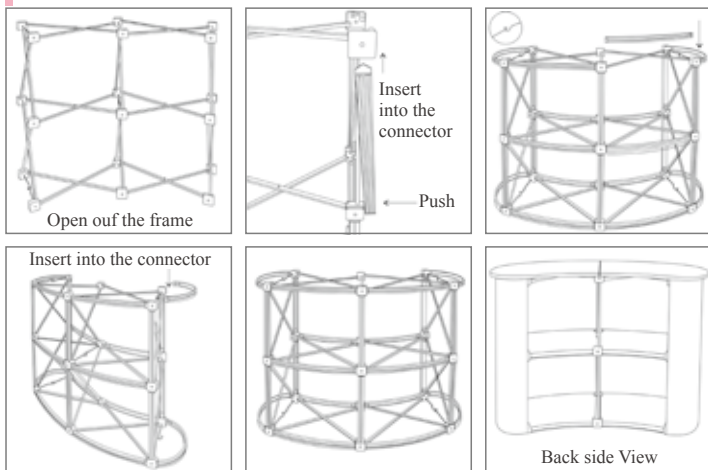

## Square Portable Counter

**Item No:** DH-S-PU-T  
**Material:** Aluminum, Plastic, Wood, Fabric, Double canvas bag  
**Graphic Size (W x H):** 177cm x 100cm (70" x 39")  
**Package Size / ctn:** 44cm x 20cm x 110cm (17" x 8" x 43") / 1pc  
**G.W. / ctn:** 13.2kg (29lb)  
**Price: ≤ \$94.21 / set**

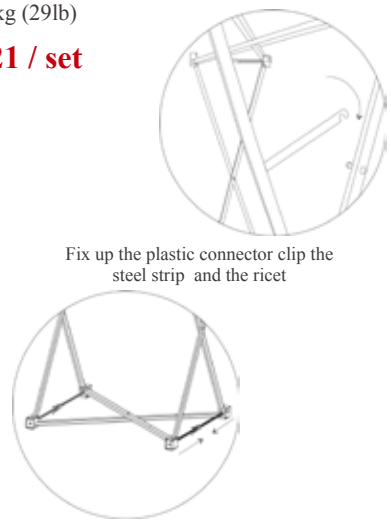
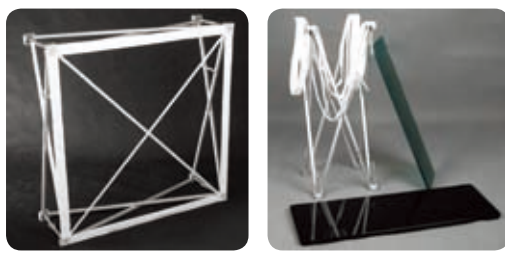

## Round Fancy Portable Counter

**Item No:** SIC-UT-T1B

**Material:** Aluminum, Plastic, Wood, PVC, Aluminum case

**Graphic Size (W x H):** 144cm x 94cm (57" x 37")

**Package Size / ctn:** 65cm x 26cm x 65cm (26" x 10" x 26") / 1pc

**G.W. / ctn:** 20.8kg (46lb)

**Price:** ≤ \$133.72 / set



## Standard Plastic Portable Counter with Top Board

**Item No:** P-SKL11-1

**Material:** Plastic, Self - adhesive photo paper, Single canvas bag

**Graphic Size (W x H):** Main graphic: 166cm x 82.3cm (65" x 32")

Top board: 77cm x 28cm (30" x 11")

**Package Size / ctn:** 94cm x 93cm x 12cm (37" x 37" x 5") / 1pc

**G.W. / ctn:** 10.5kg (23lb)

**Price:** ≤ \$62.48 / set



## Small Size Magnetic Pop up Counter

**Item No:** DH-TSC-1 x 2R

**Material:** Aluminum, Steel, Wood, PVC, Self - adhesive photo paper, Oxford bag

**Graphic Size (W x H):** 154cm x 94cm (61" x 37")

**Package Size / ctn:** 46cm x 23cm x 96cm (18" x 9" x 38") / 1pc

**G.W. / ctn:** 12kg (26lb)

**Price:** ≤ \$151.24 / set



## Big Size Magnetic Pop up Counter

**Item No:** DH-PC-SIC-01

**Material:** Aluminum, Steel, Wood, PVC, Self - adhesive photo paper, Oxford bag

**Graphic Size (W x H):** 205cm x 95cm (81" x 37")

**Package Size / ctn:** 110cm x 34cm x 48cm (43" x 13" x 19") / 1pc

**G.W. / ctn:** 22kg (48lb)

**Price:** ≤ \$157.36 / set



## &gt; Sign Holder

**Curved Edge Acrylic Sign Holder with Silver Screws****Item No:** CS-ST-799383**Material:** Acrylic**Overall Size (L x W x H):** 8cm x 27cm x 33cm (3" x 11" x 13")**Viewable Size (W x H):** 21cm x 29cm (8" x 11") or  
29cm x 21cm (11" x 8")**Package Size:** 44cm x 24cm x 30cm  
(17" x 9" x 12") / 6pcs**Price:** ≤ \$10.17 / pc**T Shape Curved Acrylic Menu Holder with Brown Square Base****Item No:** CS-ST-6900401**Material:** Acrylic**Overall Size (L x W x H):** 7cm x 10cm x 21cm  
(3" x 4" x 8")**Viewable Size (W x H):** 10cm x 20cm (4" x 8")**Package Size:** 61cm x 32cm x 14cm  
(24" x 13" x 6") / 24pcs**Price:** ≤ \$3.72 / pc**Beveled Edge Sign Holder****Item No:** CS-ST-47301**Material:** PS**Overall Size (L x W x H):**

7cm x 21cm x 30cm (3" x 8" x 12")

**Viewable Size (W x H):** 21cm x 30cm  
(8" x 12")**Package Size:** 27cm x 10cm x 33cm  
(11" x 4" x 13") / 12pcs**Price:** ≤ \$2.89 / pc**Beveled Edge Acrylic Sign Holder with Screws****Item No:** CS-ST-799493**Material:** Acrylic**Overall Size (L x W x H):**

6cm x 14cm x 19cm (2" x 6" x 7")

**Viewable Size (W x H):** 10cm x 15cm  
(4" x 6")**Package Size:** 30cm x 19cm x 17cm  
(12" x 7" x 7") / 6pcs**Price:** ≤ \$4.96 / pc**Removable T Shape Acrylic Menu Holder****Item No:** CS-ST-TM011245**Material:** Acrylic**Overall Size (L x W x H):** 7cm x 11cm x 22cm (3" x 4" x 9")**Viewable Size (W x H):** 10cm x 20cm (4" x 8")**Package Size:** 36cm x 28cm x 26cm  
(14" x 11" x 10") / 18pcs**Price:** ≤ \$3.14 / pc**T Shape Menu Holder Connect with Steel Ring****Item No:** CS-ST-HK0506202**Material:** Acrylic, Steel**Overall Size (L x W x H):** 8cm x 12cm x 29cm (3" x 5" x 11")**Viewable Size (W x H):** 10cm x 20cm (4" x 8")**Package Size:** 38cm x 38cm x 29cm  
(15" x 15" x 11") / 16pcs**Price:** ≤ \$10.08 / pc

> Sign Holder

**L Shape Sign Holder with Business Card Holder**

**Item No:** CS-ST-590601  
**Material:** PS  
**Overall Size (L x W x H):** 11cm x 23cm x 29cm (4" x 9" x 11")  
**Viewable Size (W x H):** 21cm x 28cm (8" x 11")  
**Package Size:** 36cm x 30cm x 25cm (14" x 12" x 10") / 6pcs

**Price:** ≤ \$3.97 / pc



**Acrylic Coin Box**

**Item No:** CS-ST-596901  
**Material:** Acrylic  
**Overall Size (L x W x H):** 13cm x 15cm x 20cm (5" x 6" x 8")  
**Viewable Size (W x H):** 15cm x 10cm (6" x 4")  
**Package Size:** 37cm x 34cm x 19cm (15" x 13" x 7") / 6pcs

**Price:** ≤ \$8.1 / pc



**A5 Size 4 Tier Plastic Literature Holder**

**Item No:** CS-ST-77901  
**Material:** Acrylic  
**Overall Size (L x W x H):** 16cm x 17cm x 26cm (6" x 7" x 10")  
**Viewable Size (W x H):** 16cm x 22cm (6" x 9")  
**Package Size:** 40cm x 35cm x 20cm (16" x 14" x 8") / 4pcs

**Price:** ≤ \$4.46 / pc



**1 Tier Plastic Brochure Holder - A4**

**Item No:** CS-ST-77001  
**Material:** Acrylic  
**Overall Size (L x W x H):** 10cm x 24cm x 29cm (4" x 9" x 11")  
**Viewable Size (W x H):** 22cm x 30cm (9" x 12")  
**Package Size:** 41cm x 26cm x 30cm (16" x 10" x 12") / 7pcs

**Price:** ≤ \$3.14 / pc



**1 Tier Plastic Brochure Holder - 1 / 2 A4**

**Item No:** CS-ST-77501  
**Material:** Acrylic  
**Overall Size (L x W x H):** 8cm x 11cm x 20cm (3" x 4" x 8")  
**Viewable Size (W x H):** 10cm x 21cm (4" x 8")  
**Package Size:** 39cm x 33cm x 25cm (15" x 13" x 10") / 18pcs

**Price:** ≤ \$1.65 / pc



**Horizontal Plastic Name Card Holder**

**Item No:** CS-ST-70101  
**Material:** Acrylic  
**Overall Size (L x W x H):** 4cm x 10cm x 5cm (2" x 4" x 2")  
**Viewable Size (W x H):** 9cm x 5cm (4" x 2")  
**Package Size:** 23cm x 13cm x 15cm (9" x 5" x 6") / 24pcs

**Price:** ≤ \$0.66 / pc



## &gt; Store Display Rack

**Glossy Hand Bag Rack****Item No:** SIC-CLJ01**Material:** Stainless steel**Base Size:** 12cm x 12cm x 0.3cm (4.7" x 4.7" x 0.1")**Adjustable Height:** 30cm - 60cm (11.8" - 23.6")**Package Size:** 50cm x 30cm x 20cm (19.7" x 11.8" x 7.9") / 35pcs**G.W. / ctn:** 20kg (44lb)**Price: ≤ \$8.93 / pc****High End Advertising Metal Shoes Display Stand****Item No:** SIC-CLJ08**Material:** Stainless steel**Base Size:** 9cm x 11cm x 0.3cm (3.5" x 4.3" x 0.1")**Adjustable Height:** 37cm - 41cm (14.6" - 16.2")**Package Size:** 50cm x 30cm x 20cm (19.7" x 11.8" x 7.9") / 35pcs**G.W. / ctn:** 20kg (44lb)**Price: ≤ \$16.69 / pc****Gold Scarf Display Stand****Item No:** SIC-CLJ05**Material:** Stainless steel**Base Size:** 12cm x 12cm x 0.3cm (4.7" x 4.7" x 0.1")**Adjustable Height:** 30cm - 40cm (11.8" - 15.8")**Package Size:** 50cm x 30cm x 20cm (19.7" x 11.8" x 7.9") / 35pcs**G.W. / ctn:** 20kg (44lb)**Price: ≤ \$14.88 / pc****Brand scarf display stand****Item No:** SIC-SJ11-05**Material:** Stainless steel**Base Size:** Dia 14cm (5.5")**Adjustable Height:** 33cm - 60cm (13" - 23.6")**Package Size:** 50cm x 30cm x 20cm (19.7" x 11.8" x 7.9") / 35pcs**G.W. / ctn:** 20kg (44lb)**Price: ≤ \$20.33 / pc**

> Display Light Box > Slim LED light box

### LB-LED-AC Series LED Super Slim Light Box

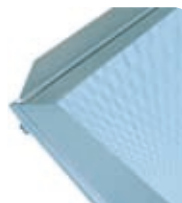

Open angle



8mm (Thickness)



- Super slim, thickness is only 8mm (0.3")
- Elaborate design, durable and delicate
- LED lighting, mild and soft, comfortable for eyes, long life - span
- Energy saving, adopting LED light source is power saving
- Even brightness, high - quality light guide panel distributes light evenly

#### ▼ How to Change Pictures

1. Turn off the power and then open the snap. 
2. Remove an old film. 
3. Insert a new film. 
4. Close the snap and then turn on the power. 

#### ▼ Specifications

Model	LB-LED-AC-A1	LB-LED-AC-A2	LB-LED-AC-A3	LB-LED-AC-A4
Overall Size	651mm x 898mm (26" x 35")	477mm x 651mm (19" x 26")	354mm x 477mm (14" x 19")	267mm x 354mm (10" x 14")
Graphic Size	594mm x 841mm (23" x 33")	420mm x 594mm (16" x 23")	297mm x 420mm (12" x 16")	210mm x 297mm (8" x 12")
Viewable Size	584mm x 831mm (23" x 33")	410mm x 584mm (16" x 23")	287mm x 410mm (11" x 16")	200mm x 287mm (8" x 11")
Thickness	8mm (0.3")	8mm (0.3")	8mm (0.3")	8mm (0.3")
Frame Width	33.5mm (1.3")	33.5mm (1.3")	33.5mm (1.3")	33.5mm (1.3")
<b>Unit Price</b>	<b>≤ \$159</b>	<b>≤ \$88</b>	<b>≤ \$58</b>	<b>≤ \$41</b>

### LB-LED-AA Series LED Narrow Slim Light Box

- Slim, thickness of 18mm (0.7")
- Aluminum frame is arc, frame width is 21.5mm (0.85")
- LED lighting, mild and soft which is comfortable for eyes
- Energy saving, adopting LED lighting
- Even brightness, high - quality even lit guide panel distributes light evenly
- Used in super market, shopping mall, hotel, restaurant, building wall, etc

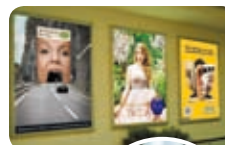

Back side



#### ▼ How to Change Pictures



#### ▼ Specifications

Model	LB-LED-AA-A1	LB-LED-AA-A2	LB-LED-AA-A3	LB-LED-AA-A4
Overall Size	627mm x 874mm (25" x 34")	453mm x 627mm (18" x 25")	330mm x 453mm (13" x 18")	243mm x 330mm (9" x 13")
Graphic Size	594mm x 841mm (23" x 33")	420mm x 594mm (16" x 23")	297mm x 420mm (12" x 16")	210mm x 297mm (8" x 12")
Viewable Size	584mm x 831mm (23" x 33")	410mm x 584mm (16" x 23")	287mm x 410mm (11" x 16")	200mm x 287mm (8" x 11")
Thickness	18mm (0.7")	18mm (0.7")	18mm (0.7")	18mm (0.7")
Frame Width	21.5mm (0.85")	21.5mm (0.85")	21.5mm (0.85")	21.5mm (0.85")
<b>Unit Price</b>	<b>≤ \$147</b>	<b>≤ \$87</b>	<b>≤ \$63</b>	<b>≤ \$42</b>

> Display Light Box > Slim LED light box

**LB-LED-AD Series Aluminum Frame LED Slim Light Box**



Side view



Acrylic panel



30mm (Width)

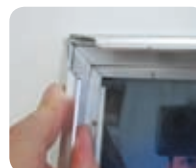

Open angle



18mm (Thickness)

- Slim, thickness of 18mm (0.7")
- Aluminum frame is flat, frame width is 30mm (1.2")
- LED lighting, mild and soft which is comfortable for eyes
- Energy saving, adopting LED lighting is power saving
- Even brightness, high - quality light guide panel distributes light evenly
- Used in super market, shopping mall, hotel, restaurant, building wall, etc



▼ Specifications

Model	LB-LED-AD-A1	LB-LED-AD-A2	LB-LED-AD-A3	LB-LED-AD-A4
Overall Size	644mm x 891mm (25" x 35")	470mm x 644mm (18" x 25")	347mm x 470mm (14" x 18")	260mm x 347mm (10" x 14")
Graphic Size	594mm x 841mm (23" x 33")	420mm x 594mm (16" x 23")	297mm x 420mm (12" x 16")	210mm x 297mm (8" x 12")
Viewable Size	584mm x 831mm (23" x 33")	410mm x 584mm (16" x 23")	287mm x 410mm (11" x 16")	200mm x 287mm (8" x 11")
Thickness	18mm (0.7")	18mm (0.7")	18mm (0.7")	18mm (0.7")
Frame Width	30mm (1.2")	30mm (1.2")	30mm (1.2")	30mm (1.2")
<b>Unit Price</b>	≤ \$147	≤ \$87	≤ \$63	≤ \$42



**LB-LED-ESL Series Double - side Slim Light Box**

- Aluminum frame is flat
- Double sided, show one more picture for good advertising effects
- LED lighting, mild and soft which is comfortable for eyes
- Energy saving, adopting LED lighting is power saving
- Even brightness, high - quality light guide panel distributes light evenly
- Used in super market, shopping hall, shopping mall, hotel, restaurant, building wall, etc



Snap open



30mm (Width)



20mm (Thickness)



▼ Specifications

Model	LB-LED-ESL-A1	LB-LED-ESL-A2	LB-LED-ESL-A3	LB-LED-ESL-A4
Overall Size	644mm x 891mm (25" x 35")	470mm x 644mm (18" x 25")	347mm x 470mm (14" x 18")	260mm x 347mm (10" x 14")
Graphic Size	594mm x 841mm (23" x 33")	420mm x 594mm (16" x 23")	297mm x 420mm (12" x 16")	210mm x 297mm (8" x 12")
Viewable Size	584mm x 831mm (23" x 33")	410mm x 584mm (16" x 23")	287mm x 410mm (11" x 16")	200mm x 287mm (8" x 11")
Thickness	20mm (0.8")	20mm (0.8")	20mm (0.8")	20mm (0.8")
Frame Width	30mm (1.2")	30mm (1.2")	30mm (1.2")	30mm (1.2")
<b>Unit Price</b>	≤ \$154	≤ \$91	≤ \$75	≤ \$48

> Display Light Box > Slim LED light box

### LB-LED-L Series Curved Snap Frame LED Slim Light Box



Lighting



Curved frame



Front



Back



45 Degree angle

- A curved snap frame makes the interchanging of posters easily
- Slender design, measuring 18mm (0.7") thick
- Includes LED lights, which provide brightness that is comfortable for the eyes
- 70 to 80% more energy efficient than traditional light boxes
- High - quality guide plate distributes light evenly
- Long life - span that can reach up to 30,000hrs, as long as the light attenuation is kept below 10% in the first 8,000hrs



#### ▼ Specifications

Model	LB-LED-L-A1	LB-LED-L-A2	LB-LED-L-A3	LB-LED-L-A4
Overall Size	627mm x 874mm (25" x 34")	450mm x 624mm (18" x 25")	327mm x 450mm (13" x 18")	240mm x 327mm (9" x 13")
Graphic Size	594mm x 841mm (23" x 33")	420mm x 594mm (16" x 23")	297mm x 420mm (12" x 16")	210mm x 297mm (8" x 12")
Viewable Size	564mm x 811mm (22" x 32")	390mm x 564mm (15" x 22")	267mm x 390mm (10" x 15")	180mm x 267mm (7" x 10")
Thickness	18mm (0.7")	18mm (0.7")	18mm (0.7")	18mm (0.7")
Frame Width	30mm (1.2")	30mm (1.2")	30mm (1.2")	30mm (1.2")
<b>Unit Price</b>	<b>≤ \$135</b>	<b>≤ \$92</b>	<b>≤ \$64</b>	<b>≤ \$46</b>

### LB-LED-K Series Round Corner LED Slim Light Box

- Add round corner, it's safe and convenient to operate
- Curved snap open frame makes it easy to change posters
- Mild and soft LED lighting, which is comfortable for eyes
- Energy saving: 70% - 80% more power saving than traditional light boxes
- High - quality even lit guide plate distributes light evenly
- Long life - span, can reach up to 30,000hrs, the light attenuation would be less than 10% in the first 8,000hrs



Thickness 18mm

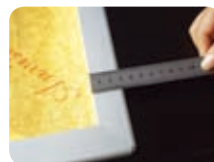

Frame width 30mm



#### ▼ Specifications

Model	LB-LED-K-A1	LB-LED-K-A2	LB-LED-K-A3	LB-LED-K-A4
Overall Size	624mm x 871mm (25" x 34")	450mm x 624mm (18" x 25")	327mm x 450mm (13" x 18")	240mm x 327mm (9" x 13")
Graphic Size	594mm x 841mm (23" x 33")	420mm x 594mm (16" x 23")	297mm x 420mm (12" x 16")	210mm x 297mm (8" x 12")
Viewable Size	564mm x 811mm (22" x 32")	390mm x 564mm (15" x 22")	267mm x 390mm (10" x 15")	180mm x 267mm (7" x 10")
Thickness	18mm (0.7")	18mm (0.7")	18mm (0.7")	18mm (0.7")
Frame Width	30mm (1.2")	30mm (1.2")	30mm (1.2")	30mm (1.2")
<b>Unit Price</b>	<b>≤ \$129</b>	<b>≤ \$93</b>	<b>≤ \$65</b>	<b>≤ \$49</b>



Back



Lighting

> Display Light Box > Slim LED light box

### LB-H-KDL Series Single - side Magnetic Slim Light Box

- Delicate Aluminum Frame
- LED lighting source, safe and durable
- Absorb cover design, easy to change pictures
- Long life - span, LED light source makes the product durable
- Even brightness, adopting superior light guide panel for high brightness and even brightness
- Widely used in supermarket, hotel, photo studio, office building, airport, shopping mall, business center, etc



17mm (Thickness)

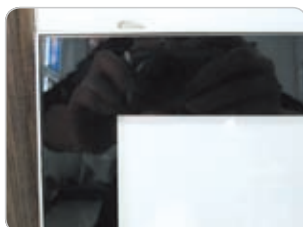

35mm (Width)



How to open



#### ▼ Specifications

Model	LB-LED-KDL-A1	LB-LED-KDL-A2	LB-LED-KDL-A3	LB-LED-KDL-A4
Overall Size	644mm x 891mm (25" x 35")	470mm x 644mm (18" x 25")	347mm x 470mm (14" x 18")	260mm x 347mm (10" x 14")
Graphic Size	608mm x 855mm (24" x 34")	434mm x 608mm (17" x 24")	311mm x 434mm (12" x 17")	224mm x 311mm (9" x 12")
Viewable Size	568mm x 815mm (22" x 32")	394mm x 568mm (15" x 22")	271mm x 394mm (11" x 15")	184mm x 271mm (7" x 11")
Thickness	17mm (0.7")	17mm (0.7")	17mm (0.7")	17mm (0.7")
Frame Width	35mm (1.4")	35mm (1.4")	35mm (1.4")	35mm (1.4")
<b>Unit Price</b>	<b>≤ \$171</b>	<b>≤ \$104</b>	<b>≤ \$71</b>	<b>≤ \$55</b>

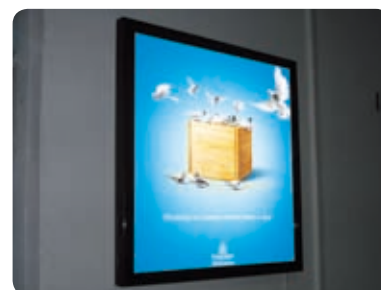

### LB-H-KST Series Double - Side Magnetic Slim Light Box



- Absorb cover design, easy to change pictures
- Double sided, show one more picture for good advertising effect
- LED lighting source, safe and durable, long life - span
- Even brightness, adopting superior light guide panel for high brightness and even brightness
- Widely used in supermarket, hotel, airport, shopping mall, business center, etc



35mm (Thickness)

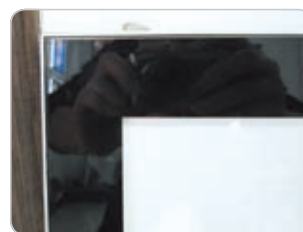

40mm (Width)

#### ▼ Specifications

Model	LB-LED-KST-A1	LB-LED-KST-A2	LB-LED-KST-A3	LB-LED-KST-A4
Overall Size	655mm x 902mm (26" x 35")	481mm x 655mm (19" x 26")	358mm x 481mm (14" x 19")	271mm x 358mm (11" x 14")
Graphic Size	594mm x 841mm (23" x 33")	420mm x 594mm (17" x 23")	297mm x 420mm (12" x 17")	210mm x 297mm (8" x 12")
Viewable Size	574mm x 821mm (22" x 32")	400mm x 574mm (16" x 22")	277mm x 400mm (11" x 16")	190mm x 277mm (7" x 11")
Thickness	35mm (1.4")	35mm (1.4")	35mm (1.4")	35mm (1.4")
Frame Width	40mm (1.6")	40mm (1.6")	40mm (1.6")	40mm (1.6")
<b>Unit Price</b>	<b>≤ \$274</b>	<b>≤ \$164</b>	<b>≤ \$105</b>	<b>≤ \$69</b>





> Display Light Box > Acrylic crystal light box

**LB-LED-CA Series SINGLE SIDE Crystal Light Box**

- Crystal material, diamond side polished
- Super slim, thickness of 8mm (0.3")
- Elaborate design, durable and delicate
- LED lighting, high brightness
- Energy saving, 60% - 75% energy saving than traditional ones
- High - quality light guide panel distributes light evenly
- Used in commercial centers, malls, shops, banks, restaurants, hotels, POS & POP displays, etc

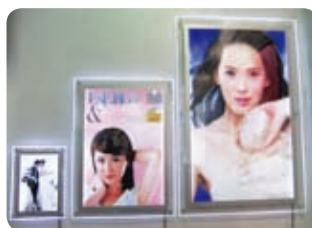

▼ Specifications

Model	LB-LED-CA-A1	LB-LED-CA-A2	LB-LED-CA-A3	LB-LED-CA-A4
Overall Size	702mm x 949mm (28" x 37")	510mm x 684mm (20" x 27")	398mm x 521mm (16" x 20")	281mm x 368mm (11" x 14")
Graphic Size	594mm x 841mm (23" x 33")	420mm x 594mm (17" x 23")	297mm x 420mm (12" x 17")	210mm x 297mm (8" x 12")
Viewable Size	574mm x 821mm (22" x 32")	410mm x 584mm (16" x 23")	287mm x 410mm (11" x 16")	200mm x 287mm (8" x 11")
Thickness	8mm (0.3")	8mm (0.3")	7mm (0.3")	7mm (0.3")
<b>Unit Price</b>	<b>≤ \$175</b>	<b>≤ \$96</b>	<b>≤ \$62</b>	<b>≤ \$36</b>

▼ How to Change Pictures

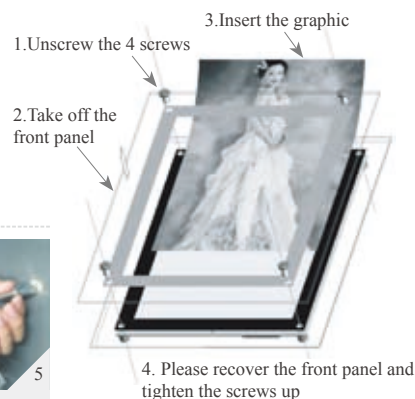

**LB-LED-CSL Series DOUBLE SIDED Crystal Light Box**

- Crystal material, diamond side polished
- Double sides, show one more picture for better advertising effects
- Elaborate design, durable and delicate
- LED lighting, high brightness
- Energy saving, 60% - 75% energy saving than traditional ones
- High - quality light guide panel distributes light evenly
- Used in Commercial centers, malls, shops, banks, restaurants, hotels, POS & POP displays, etc



▼ Specifications

Model	LB-LED-CSL-A1	LB-LED-CSL-A2	LB-LED-CSL-A3	LB-LED-CSL-A4
Overall Size	702mm x 949mm (28" x 37")	510mm x 684mm (20" x 27")	398mm x 521mm (16" x 20")	281mm x 368mm (11" x 14")
Graphic Size	594mm x 841mm (23" x 33")	420mm x 594mm (17" x 23")	297mm x 420mm (12" x 17")	210mm x 297mm (8" x 12")
Viewable Size	574mm x 821mm (22" x 32")	400mm x 574mm (16" x 22")	277mm x 400mm (11" x 16")	190mm x 277mm (7" x 11")
Thickness	12mm (0.5")	12mm (0.5")	12mm (0.5")	12mm (0.5")
<b>Unit Price</b>	<b>≤ \$178</b>	<b>≤ \$112</b>	<b>≤ \$71</b>	<b>≤ \$51</b>

## LB-LED-CUI Series Unique Design Crystal Slim Light Box with Engraving Logo



- Unique design, any crystal logo can be engraved
- Made of clear acrylic, for delicate outer appearance
- Energy saving, adopting LED light that is 75% power saving compared with traditional light box
- LED lighting, mild and soft which is comfortable for eyes
- Long life - span, can reach 30,000hrs, and make sure the light attenuation would be less than 10% in the first 8,000hrs
- Can be displayed on the countertop, wall-mount, hanging. Also could be displayed horizontally or vertically



### ▼ Specifications

Model	LB-LED-CUI-A1	LB-LED-CUI-A2	LB-LED-CUI-A3	LB-LED-CUI-A4
Overall Size	674mm x 921mm (26" x 36")	500mm x 674mm (20" x 26")	377mm x 500mm (15" x 20")	290mm x 377mm (12" x 15")
Graphic Size	594mm x 841mm (23" x 33")	420mm x 594mm (17" x 23")	297mm x 420mm (12" x 17")	210mm x 297mm (8" x 12")
Viewable Size	574mm x 821mm (22" x 32")	400mm x 574mm (16" x 22")	287mm x 410mm (11" x 16")	200mm x 287mm (8" x 11")
Thickness	8mm (0.3")	8mm (0.3")	8mm (0.3")	8mm (0.3")
<b>Unit Price</b>	<b>≤ \$140</b>	<b>≤ \$101</b>	<b>≤ \$68</b>	<b>≤ \$49</b>

## LB-LED-HDL Series Crystal Battery Light Box



- Crystal material, diamond side polished.
- Battery energy supporting.
- Elaborate design, smart and portable.
- LED lighting, high brightness.
- Energy saving, 60% - 75% energy saves than traditional ones.
- High - quality light guide panel distributes light evenly.
- Used in commercial centers, malls, shops, banks, supermarkets, hotels, POS & POP displays, etc.

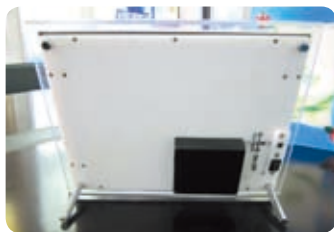

### ▼ Specifications

Model	LB-LED-HDL-4R	LB-LED-HDL-6R	LB-LED-HDL-8R
Overall Size	147mm x 198mm (6" x 8")	198mm x 249mm (8" x 10")	324mm x 273mm (13" x 11")
Graphic Size	101mm x 152mm (4" x 6")	152mm x 203mm (6" x 8")	264mm x 213mm (10" x 8")
Viewable Size	91mm x 142mm (3.6" x 5.6")	137mm x 188mm (5.4" x 7.4")	254mm x 203mm (10" x 8")
Thickness	8mm (0.3")	8mm (0.3")	8mm (0.3")
<b>Unit Price</b>	<b>≤ \$19</b>	<b>≤ \$28</b>	<b>≤ \$41</b>

> Display Light Box > Magic light box

### MLB-CY Series Acrylic Magic Mirror Light Box

Widely used in shopping mall, hotel, restaurant, house, school, etc for business advertising.



- Long life-span, adopting LED lighting which can reach 30,000hrs
- Energy - saving, 75% power saving compared with traditional light box
- Response promptly, using infrared ray sensor to change between mirror and light box
- Equal lighting and suitable brightness, adopt high - quality LGP for evenly light distribution

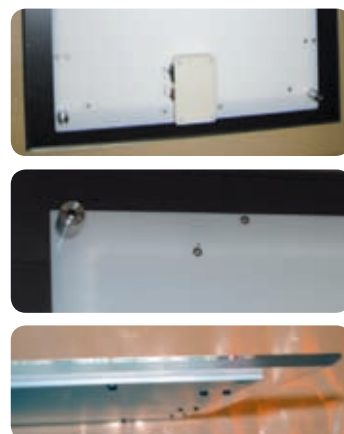

#### ▼ Specifications

Model	MLB-CY-A1	MLB-CY-A2	MLB-CY-A3
Overall Size	680mm x 920mm x 25mm (27" x 36" x 1")	470mm x 644mm x 25mm (18.5" x 26" x 1")	347mm x 470mm x 25mm (13.7" x 18.5" x 1")
Graphic Size	594mm x 841mm (23" x 33")	420mm x 594mm (16.5" x 23")	297mm x 420mm (11.7" x 16.5")
Viewable Size	584mm x 831mm (23" x 33")	410mm x 584mm (16" x 23")	287mm x 410mm (11" x 16")
Thickness	25mm (1")	25mm (1")	25mm (1")
<b>Unit Price</b>	<b>≤ \$226</b>	<b>≤ \$132</b>	<b>≤ \$85</b>

### MLB-CY-SG4: MULTI - PICTURES Acrylic Magic Mirror Light Box

Widely used in restaurant, hotel, home, school, shopping mall, etc.

- Multi - pictures, you can show 4 pictures
- Adopt infrared sensor, changing between mirror and light box
- Long life - span, adopting LED lighting which can reach 30,000hrs
- Energy - saving, 75% power saving compared with traditional light box
- Equal lighting and suitable brightness, adopt high - quality LGP for evenly light distribution



#### ▼ Specifications

Model	Overall Size	Graphic Size	Viewable Size	Unit Price
MLB-CY-SG4	685mm x 510mm x 50mm (27" x 20" x 2")	594mm x 420mm (23" x 16.5")	297mm x 210mm (11.7" x 8") (4pcs)	≤ \$166

> Display Light Box > Magic light box

### MLB-CY-GR: Acrylic Magic Mirror Light Box

Just as mirror used in hotel, restaurant, house, school, etc. Also for advertisement.

- Round shape, it's a novel style to attract people
- Long life - span, adopting LED lighting for long life - span
- Energy saving, 70% - 80% energy saving than the traditional light box
- Equal lighting and suitable brightness, adopt high - quality LGP for evenly light distribution



▼ Specifications

Model	Size	Lighting	Unit Price
MLB-CY-GR	510mm (20") (Diameter)	LED	≤ \$173

### MLB-AL Series ALUMINUM Magic Mirror Light Box

Widely used in shopping mall, hotel, restaurant, house, school, etc.

- SMD LED lighting for long life - span
- Aluminum magic mirror, it's durable and won't out of shape easily
- Key lock, it's easy to replace picture and install
- 70% - 80% energy saving than the traditional light box
- Control on / off by infrared ray sensor, when people approach, it displays as a mirror, when people away, it displays as a picture



▼ Specifications

Model	MLB-AL-A1	MLB-AL-A2	MLB-AL-A3
Overall Size	644mm x 891mm (25" x 35")	470mm x 644mm (18.5" x 25")	347mm x 470mm (13.7" x 18.5")
Graphic Size	594mm x 841mm (23" x 33")	420mm x 594mm (16.5" x 23")	297mm x 420mm (11.7" x 16.5")
Viewable Size	584mm x 831mm (23" x 33")	410mm x 584mm (16" x 23")	287mm x 410mm (11" x 16")
Thickness	20mm (0.8")	20mm (0.8")	20mm (0.8")
Unit Price	≤ \$144	≤ \$118	≤ \$85

## &gt; Display Light Box &gt; Rotating &amp; scrolling light box

**SLB-T-SA01: Single Side Scrolling Light Box with LED Display**

Adopting electronic and digital control technologies.

Running synchronously to deliver breath - taking visual effect.

8 different scrolling speeds at 60 - 220 round / min.

Automatic poster setting function.

Used in outdoor or indoor, such as street, road, airport, stations, supermarket, mall, etc.

- Synchronization
- Short circuit protection
- Waterproof and cool
- Wireless remote controlling
- LED message display shows date and time

**▼ Specifications**

Model	Overall Size	Graphic Size	Viewable Size	Unit Price
SLB-T-SA01	1.79m x 2.16m x 0.36m (70" x 85" x 14")	1.255m x 1.575m (49" x 62")	0.91m x 1.5m (36" x 59")	≤ \$1,856

**SLB-L-01: 1200mm x 1600mm (47" x 63") Double Sides Scrolling Light Box**

Running synchronously to deliver breath - taking visual effect.

8 different scrolling speeds at 60 - 220 round / min.

Significant advantages in both functionality and reliability.

Multi - image advertising or information billboard designed for both indoor and outdoor applications, such as street, square, station, mall, chain - store, etc.

- Double sides, one side is scrolling and the other side is fixed poster
- Automatic poster setting function
- Short circuit protection
- Waterproof and cool

**▼ Specifications**

Model	Overall Size	Graphic Size	Viewable Size	Unit Price
SLB-L-01	1.2m x 1.6m x 0.21m (47" x 63" x 8")	1.06m x 1.36m (42" x 53")	0.94m x 1.34m (37" x 53")	≤ \$1,415

## &gt; Display Light Box &gt; Rotating &amp; scrolling light box

**SLB-L-02: 920mm x 1410mm (36" x 55.5") Double Sides Scrolling Light Box**

Designed with LED Message Display

- Synchronization
- Short circuit protection
- Waterproof and cool
- Wireless remote control
- Intelligent Scrolling
- Timing and Waterproof
- Multi-function checking automatically
- Bilingual Menu (Chinese and English)



Poster orientation when machine stops working as presetting.

Double sided, one side is scrolling and the other is fixed poster.

Applying in both outdoor and indoor, such as street, square, airport, station, mall, chain - store, etc.

## ▼ Specifications

Model	Overall Size	Graphic Size	Viewable Size	Unit Price
SLB-L-02	1.25m x 2m x 0.4m (49" x 79" x 16")	0.92m x 1.41m (36" x 55.5")	0.9m x 1.35m (35" x 53")	≤ \$1,658

**SLB-L-03: 1250mm x 2000mm (49" x 79") Double Sides Scrolling Light Box**

- Double sides, one side is scrolling and the other is fixed poster
- Automatic poster setting function
- Stylish design, durable and stable
- Qualified installation



Adopting electronic and digital control technologies.

Stylish with double sides and stable base.

Running synchronously to deliver breath - taking visual effect.

Multi - image advertisements designed for both indoor and outdoor applications, such as street, square, station, mall, chain - store, etc.

## ▼ Specifications

Model	Overall Size	Graphic Size	Viewable Size	Unit Price
SLB-L-03	1.25m x 2m x 0.4m (49" x 79" x 16")	0.95m x 1.67m (37" x 66")	0.9m x 1.58m (36" x 62")	≤ \$1,406

## &gt; Display Light Box &gt; Rotating &amp; scrolling light box

**SLB-L-04: 1000mm x 2000mm (39" x 79") Delicate Double Sides Scrolling Light**

- Double sides, unique outer appearance
- Automatic poster setting function
- Short circuit protection
- Waterproof and cool

Running synchronously to deliver breath - taking visual effect.  
8 different scrolling speeds at 60 - 220 r / min.  
Significant advantages in both functionality and reliability.  
Double sides, one side is scrolling sign, and the other side is static poster.



Multi-image advertisements can be showed for both indoor and outdoor applications, such as street, square, station, mall, chain - store, etc.

## ▼ Specifications

Model	Overall Size	Graphic Size	Viewable Size	Unit Price
SLB-L-04	1m x 2m x 0.4m (39" x 79" x 16")	0.85m x 1.39m (33" x 55")	0.8m x 1.3m (31" x 51")	≤ \$1,352

**SLB-L-05: 1300mm x 2400mm (51" x 94") Unique Design Double Sides Scrolling Light Box**

- Unique design, delicate outer appearance
- Automatic poster setting function, short circuit protection
- Waterproof and cool, can be used in both indoor and outdoor
- Double sides, one side is scrolling and the other is fixed poster

Running synchronously to deliver breath - taking visual effect. 8 different scrolling speeds at 60 - 220 r / min.  
Significant advantages in both functionality and reliability.  
Multi - Graphic advertising can be showed for both indoor and outdoor applications, such as street, square, station, mall, chain - store, etc.

## ▼ Specifications

Model	Overall Size	Graphic Size	Viewable Size	Unit Price
SLB-L-05	1.3m x 2.4m x 0.21m (51" x 94" x 8")	0.85m x 1.49m (33" x 58.7")	0.8m x 1.4m (31" x 55")	≤ \$1,458

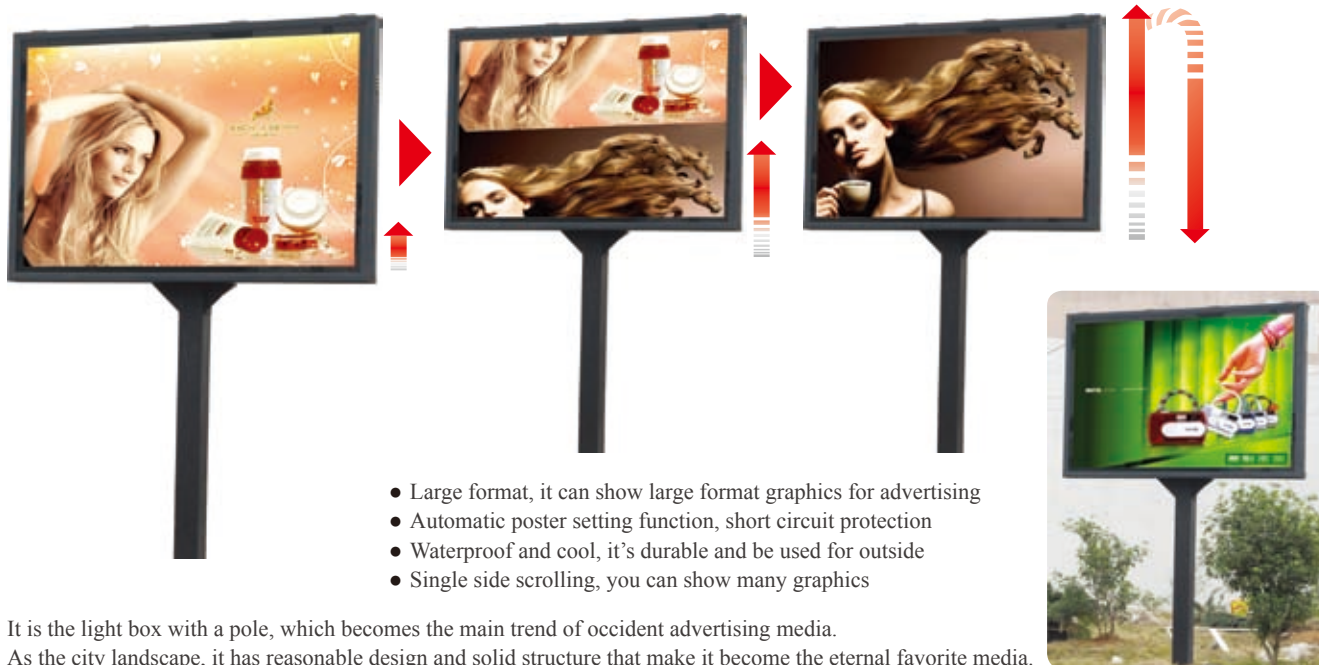
**SLB-L-06: 3000mm x 4300mm (118" x 169") Single Side Scrolling Light Box**

- Large format, it can show large format graphics for advertising
- Automatic poster setting function, short circuit protection
- Waterproof and cool, it's durable and be used for outside
- Single side scrolling, you can show many graphics

It is the light box with a pole, which becomes the main trend of occident advertising media. As the city landscape, it has reasonable design and solid structure that make it become the eternal favorite media.

**▼ Specifications**

Model	Overall Size	Graphic Size	Viewable Size	Unit Price
SLB-L-06	3m x 4.3m x 0.32m (118" x 169" x 12.6")	1.86m x 2.88m (73" x 113")	1.8m x 2.8m (71" x 110")	≤ \$4,483

**SLB-L-07: 1250mm x 2000mm (49" x 79") Double Sides Scrolling Light Box**

- Double sides, one side is scrolling and the other side is fixed poster.
- Automatic poster setting function
- Stylish design, durable and stable
- Qualified installation



Adopting electronic and digital control technologies.

Stylish with double sides and stable base.

Running synchronously to deliver breath - taking visual effect.

Multi - image advertisements showed for both indoor and outdoor applications, such as street, square, stations, malls, chain - stores, etc.

**▼ Specifications**

Model	Overall Size	Graphic Size	Viewable Size	Unit Price
SLB-L-07	1.25m x 2m x 0.45m (49" x 79" x 18")	1.1m x 1.64m (43" x 64.6")	1.05m x 1.55m (41" x 61")	≤ \$1,368



> LCD Advertising Player

**ADP-LCD-TA Series Advertising Player with Infrared Sensor for Taxi**

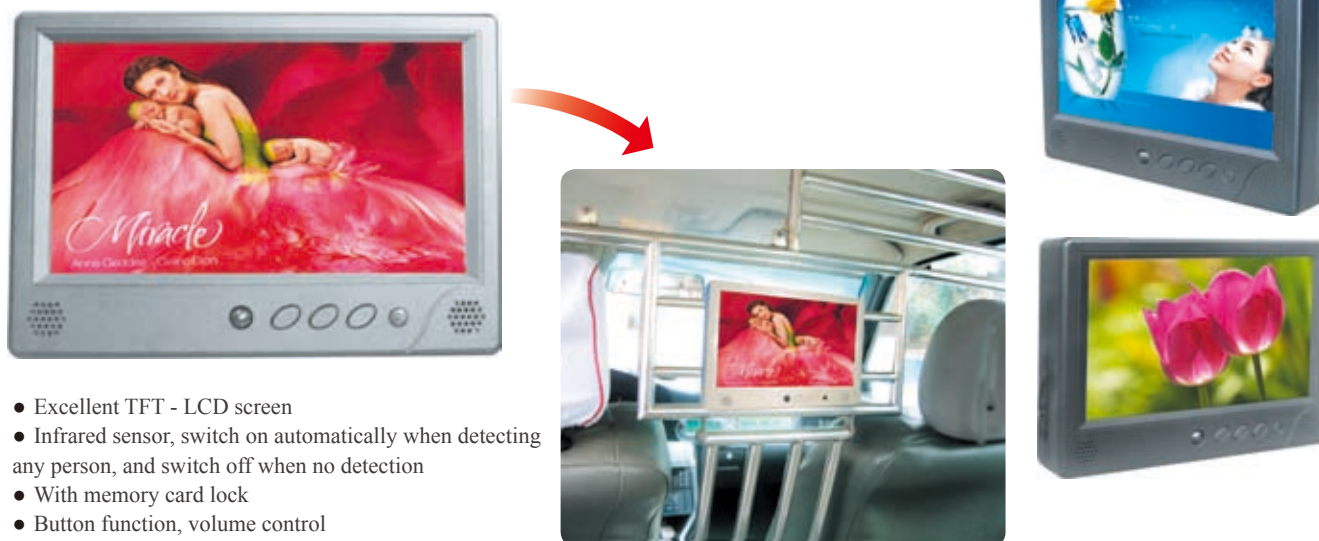

- Excellent TFT - LCD screen
- Infrared sensor, switch on automatically when detecting any person, and switch off when no detection
- With memory card lock
- Button function, volume control
- Replay automatically and built - in stereo speakers
- Support SD card and JPEG, MPEG1, MPEG2, MPEG3, MPEG4, MP3 formats
- Used in taxi, various fixing ways, such as security - rail fixing, central fixing, headrest back hitching, roof mounting, etc

▼ Specifications

Model	Size	Product Size	Resolution	Unit Price
ADP-LCD-TA7008A	178mm (7 inch)	185mm x 130mm x 33mm (7.3" x 5" x 1.3")	480 x 234	≤ \$135
ADP-LCD-TA9008A	228mm (9 inch)	230mm x 155mm x 35mm (9" x 6" x 1.4")	640 x 234	≤ \$159

**ADP-LCD-THA Series Taxi Advertising Player with Headrest Fixing Way**



- Infrared sensor, switch on automatically when detecting any person, and switch off when no motion
- With memory card lock
- Button function, volume control
- Replay automatically and built - in stereo speakers
- Support SD card and JPEG, MPEG1, MPEG2, MPEG3, MPEG4, MP3 formats
- Used in taxi and headrest fixing way

▼ Specifications

Model	Size	Product Size	Resolution	Unit Price
ADP-LCD-THA7008A	178mm (7 inch)	290mm x 105mm x 200mm (11.4" x 4" x 7.9")	480 x 234	≤ \$135
ADP-LCD-THA9008A	228mm (9 inch)	290mm x 220mm x 115mm (11.4" x 8.7" x 4.6")	640 x 234	≤ \$159

## &gt; LCD Advertising Player

**ADP-LCD-BA Series I Bus Advertising Player with Front Folding Fixing Structure**

- Excellent TFT - LCD screen
- Widely visual angle, high resolution
- Shockproof design and front folding fixing structure
- Operate with remote
- The player could be configured to play specific programme at specific time
- Memorized on power - off, scrolling text display, time display, USB file auto - copy and circular playback
- Sizes: 15 inch, 17 inch, 19 inch, etc
- Used in public vehicles, such as bus, subway, long-distance bus, train, etc



## ▼ Specifications

Model	Size	Product Size	Resolution	Unit Price
ADP-LCD-BA1501	381mm (15 inch)	420mm x 310mm x 120mm (16.5" x 12" x 4.7")	1024 x 768	≤ \$371
ADP-LCD-BA1701	432mm (17 inch)	450mm x 360mm x 120mm (17.7" x 14" x 4.7")	1280 x 1024	≤ \$423
ADP-LCD-BA1901	483mm (19 inch)	490mm x 380mm x 120mm (19.3" x 15" x 4.7")	1280 x 1024	≤ \$436

**ADP-LCD-BA Series II Bus Advertising Player Back Hitch Fixing Structure**

- Excellent TFT - LCD screen
- Widely visual angle, high resolution
- Back hitch fixing structure
- Remote operation, horizontal type
- The player could be configured to play specific programme at specific time
- Memorized on power - off, scrolling text display, time display, USB file auto - copy and circular playback
- Sizes: 15 inch, 17 inch, 19 inch, 20 inch, etc
- Used in public vehicles, such as bus, subway, long-distance bus, train etc

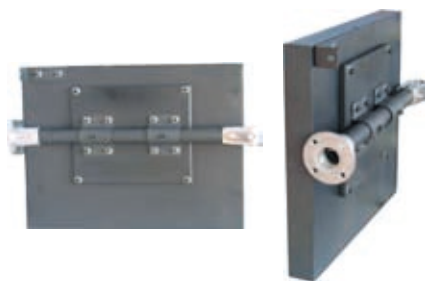

## ▼ Specifications

Model	Size	Product Size	Resolution	Unit Price
ADP-LCD-BA1503	381mm (15 inch)	520mm x 320mm x 40mm (20.5" x 12.6" x 1.6")	1024 x 768	≤ \$371
ADP-LCD-BA1703	432mm (17 inch)	398mm x 375mm x 45mm (15.7" x 14.8" x 1.8")	1280 x 1024	≤ \$436
ADP-LCD-BA1903	483mm (19 inch)	471mm x 390mm x 42mm (18.5" x 15.4" x 1.7")	1280 x 1024	≤ \$460

# 04 LED PRODUCTS



Price: ≤ \$0.32 / pc  
on P326



Price: ≤ \$2.88 / pc  
on P317



Price: ≤ \$1.39 / pc  
on P327

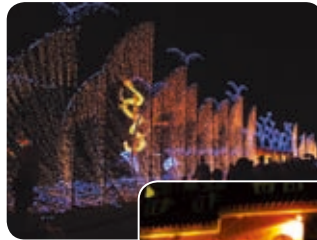

Price: ≤ \$3.88 / pc  
on P317

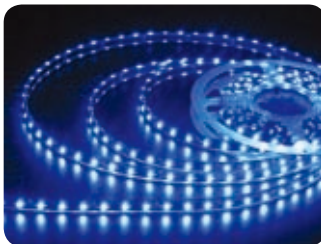

- P314 | LED Innovative Products
- P319 | LED Full Color Screen
- P323 | LED Scrolling Sign
- P326 | LED Modules

- P329 | Decorative Light
  - P329 | Decorative light
  - P333 | Rope light string
  - P335 | LED strip

## &gt; LED Innovative Products

**LED Advertising Message Fan**

- LED advertising message fan using the rotating feature of its cleverly.
- For the persistence of human vision, the fan can display some message letters or patterns during it's working / running / rotating.
- As a novel advertising gift, it is welcomed by both women and men.
- By displaying letters on fans and printing company logo on the handle make it more attractive than normal advertising gifts.
- What's more we design various types for customer.



Model	Name	Light Qty	Display Content
FS-SZTB-TBD108-5	Portable Mini LED Fan		
FS-SZTB-TBD158-5	USB LED Message Fan-with ON / OFF Switch	5 LEDS	Design any Capital English letters, numbers or common punctuation marks, etc.
FS-SZTB-TBD168-5	USB Desktop LED Message Fan		
FS-SZTB-TBD108-7	Portable Mini LED Fan		
FS-SZTB-TBD158-7	USB LED Message Fan-with ON / OFF Switch	7 LEDS	Design any European letters, numbers, common punctuation marks and simple patterns etc. Four different messages can be shown, 14 - 16 letters for each message.
FS-SZTB-TBD168-7	USB Desktop LED Message Fan		
FS-SZTB-TBD108-9	Portable Mini LED Fan		
FS-SZTB-TBD158-9	USB LED Message Fan-with ON / OFF Switch	9 LEDS	Design any European letters, Japanese, Korean, numbers, common punctuation marks and simple patterns, etc. Four different messages can be shown 14 - 16 letters for each message. Four different messages can be shown, 14 - 16 letters for each message.
FS-SZTB-TBD168-9	USB Desktop LED Message Fan		
FS-SZTB-TBD108-11	Portable Mini LED Fan		
FS-SZTB-TBD158-11	USB LED Message Fan-with ON / OFF Switch	11 LEDS	Design any European letters, Japanese, Korean, Thai, numbers, common punctuation marks and simple patterns, etc. Four different messages can be shown, 14 - 16 letters for each message.
FS-SZTB-TBD168-11	USB Desktop LED Message Fan		
FS-SZTB-TBD108-16	Portable Mini LED Fan		
FS-SZTB-TBD168-16	USB Desktop LED Message Fan	16 LEDS	Design any words or simple patterns, including European letter, Simple Chinese, Complicated Chinese, Japanese, Korean, Thai and company logo, etc. Four different messages can be shown, 14 - 16 letters for each message.

## &gt; LED Innovative Products

**Portable Mini LED Fan**

## ▼ Specifications

**Product Size:** 11cm x 3.5cm x 5cm (4.3" x 1.4" x 2")**Carton Size:** 11.5cm x 5cm x 4.5cm (4.5" x 2" x 1.8")**Product Weight:** 60g**Power:** 3pcs AAA battery**Packing Size:** 54.3cm x 48.8cm x 28cm  
(21.4" x 19" x 11")**Qty / Carton:** 200pcs**N.W.:** 12.2kgs**G.W.:** 14.1kgs

## ▼ Price List

Model	Light Qty	Light Color	MOQ	0.5k-1k	1k-2k	2k-3k
FS-SZTB-TBD108-5	5	Red	500pcs	\$1.38 / pc	\$1.33 / pc	\$1.28 / pc
	5	Blue	500pcs	\$1.52 / pc	\$1.49 / pc	\$1.42 / pc
	5	Green	500pcs	\$1.55 / pc	\$1.50 / pc	\$1.45 / pc
FS-SZTB-TBD108-7	7	Red	500pcs	\$1.44 / pc	\$1.39 / pc	\$1.34 / pc
	7	Blue	500pcs	\$1.62 / pc	\$1.57 / pc	\$1.52 / pc
	7	Green	500pcs	\$1.65 / pc	\$1.60 / pc	\$1.55 / pc
FS-SZTB-TBD108-9	9	Red	500pcs	\$1.56 / pc	\$1.51 / pc	\$1.46 / pc
	9	Blue	500pcs	\$1.82 / pc	\$1.77 / pc	\$1.72 / pc
	9	Green	500pcs	\$1.83 / pc	\$1.78 / pc	\$1.73 / pc
FS-SZTB-TBD108-11	11	Red	500pcs	\$1.61 / pc	\$1.56 / pc	\$1.51 / pc
	11	Blue	500pcs	\$1.92 / pc	\$1.87 / pc	\$1.82 / pc
	11	Green	500pcs	\$1.94 / pc	\$1.89 / pc	\$1.84 / pc
FS-SZTB-TBD108-16	16	Red	500pcs	\$2.25 / pc	\$2.20 / pc	\$2.15 / pc
	16	Blue	500pcs	\$2.51 / pc	\$2.46 / pc	\$2.41 / pc
	16	Green	500pcs	\$2.94 / pc	\$2.89 / pc	\$2.84 / pc

**USB Desktop LED Message Fan**

## ▼ Specifications

**Product Size:** 9cm x 10cm x 26.3cm (3.5" x 3.9" x 10.4")**Package Size:** 8.5cm x 8.5cm x 10.5cm (3.3" x 3.3" x 4.1")**Power:** USB or 3pcs AAA battery**Product Weight:** 150g**Carton Size:** 45.5cm x 45.5cm x 47cm (17.9" x 17.9" x 18.5")**Qty / Carton:** 100pcs**N.W.:** 15kg**G.W.:** 17kg

## ▼ Price List

Model	Light Qty	Light Color	MOQ	1k-2k	2k-5k	5k-10k
FS-SZTB-TBD168-5	5	Red	1000pcs	\$2.63 / pc	\$2.60 / pc	\$2.57 / pc
	5	Blue	1000pcs	\$2.76 / pc	\$2.73 / pc	\$2.70 / pc
	5	Green	1000pcs	\$2.78 / pc	\$2.75 / pc	\$2.72 / pc
FS-SZTB-TBD168-7	7	Red	1000pcs	\$2.66 / pc	\$2.63 / pc	\$2.60 / pc
	7	Blue	1000pcs	\$2.85 / pc	\$2.82 / pc	\$2.79 / pc
	7	Green	1000pcs	\$2.88 / pc	\$2.85 / pc	\$2.82 / pc
FS-SZTB-TBD168-9	9	Red	1000pcs	\$2.76 / pc	\$2.73 / pc	\$2.70 / pc
	9	Blue	1000pcs	\$2.95 / pc	\$2.92 / pc	\$2.89 / pc
	9	Green	1000pcs	\$2.98 / pc	\$2.95 / pc	\$2.92 / pc
FS-SZTB-TBD168-11	11	Red	1000pcs	\$2.79 / pc	\$2.76 / pc	\$2.73 / pc
	11	Blue	1000pcs	\$3.11 / pc	\$3.08 / pc	\$3.05 / pc
	11	Green	1000pcs	\$3.12 / pc	\$3.09 / pc	\$3.06 / pc
FS-SZTB-TBD168-16	16	Red	1000pcs	\$3.20 / pc	\$3.17 / pc	\$3.14 / pc
	16	Blue	1000pcs	\$3.47 / pc	\$3.44 / pc	\$3.41 / pc
	16	Green	1000pcs	\$3.90 / pc	\$3.87 / pc	\$3.84 / pc

> LED Innovative Products

**USB LED Message Fan**



▼ Specifications

**Product Size:** 33.2cm x 3.3cm x 2.6cm (13" x 1.3" x 1")

**Carton Size:** 11.5cm x 5cm x 4.5cm (4.3" x 2" x 1.8")

**Product Weight:** 58.6g

**Power:** USB

**Packing Size:** 54.3cm x 48.8cm x 28cm  
(21.4" x 19.2" x 11")

**Qty / Carton:** 200pcs

**N.W.:** 13.72kgs

**G.W.:** 15.62kgs



▼ Price List

Model	Light Qty	Light Color	MOQ	0.5k-1k	1k-2k	2k-3k
FS-SZTB-TBD158-5	5	Red	500pcs	\$2.54 / pc	\$2.51 / pc	\$2.48 / pc
	5	Blue	500pcs	\$2.67 / pc	\$2.64 / pc	\$2.61 / pc
	5	Green	500pcs	\$2.69 / pc	\$2.66 / pc	\$2.63 / pc
FS-SZTB-TBD158-7	7	Red	500pcs	\$2.57 / pc	\$1.39 / pc	\$1.34 / pc
	7	Blue	500pcs	\$2.76 / pc	\$2.73 / pc	\$2.70 / pc
	7	Green	500pcs	\$2.79 / pc	\$2.76 / pc	\$2.73 / pc
FS-SZTB-TBD158-9	9	Red	500pcs	\$2.82 / pc	\$2.79 / pc	\$2.76 / pc
	9	Blue	500pcs	\$3.08 / pc	\$3.05 / pc	\$3.02 / pc
	9	Green	500pcs	\$3.09 / pc	\$3.06 / pc	\$3.03 / pc
FS-SZTB-TBD158-11	11	Red	500pcs	\$2.85 / pc	\$2.82 / pc	\$2.79 / pc
	11	Blue	500pcs	\$3.17 / pc	\$3.14 / pc	\$3.11 / pc
	11	Green	500pcs	\$3.18 / pc	\$3.15 / pc	\$3.12 / pc

**LED Flashing Mobile Phone Chains**

- It is a new kind of LED flashing mobile phone chains. Based on the theory of persistence of vision, it would seem like fluorescent words or figures only by swaying or twirling it, and different speeds, rhythms, or waving ways would produce different effects.
- Smart but clear.
- The background picture could be changed.
- Different display effects including Chinese, English, Korean, Japanese or French versions for your choice.
- One intellectual button makes it easy to operate.
- Can be used 500 minutes consecutively.



▼ Price List

Model	Light Color	MOQ	Unit Price
MS-LZYW-602R-3	Red	100pcs	\$4.24 / pc
MS-LZYW-602G-3	Green	100pcs	\$4.54 / pc
MS-LZYW-602B-3	Blue	100pcs	\$4.84 / pc



## &gt; LED Innovative Products

**PC Input LED Message Fan**

- It is a personalized gift which can change the flashing letters by connecting computer.
- The advertising contents can only be changed by USB cable. The oretical changing time can be up to 10,000 times.
- One data line could work for many PC input led mini fans.

**PC Input Portable Mini LED Message Fan****▼ Specifications****Product Size:** 11cm x 3.5cm x 5cm (4.3" x 1.4" x 2")**Carton Size:** 11.5cm x 5cm x 4.5cm (4.5" x 2" x 1.8")**Product Weight:** 60g**Power:** 3pcs AAA battery**Packing Size:** 54.3cm x 48.8cm x 28cm  
(21.4" x 19.2" x 11")**Qty / Carton:** 200pcs**N.W.:** 12.6kgs**G.W.:** 14.5kgs**▼ Price List**

Model	Light Qty	Light Color	MOQ	0.5k-1k	1k-2k	2k-3k
FS-SZTB-TBD128-7	7	Red	500pcs	\$2.88 / pc	\$2.85 / pc	\$2.82 / pc
	7	Blue	500pcs	\$3.08 / pc	\$3.03 / pc	\$3.00 / pc
	7	Green	500pcs	\$3.21 / pc	\$3.18 / pc	\$3.15 / pc
FS-SZTB-TBD128-11	11	Red	500pcs	\$3.50 / pc	\$3.40 / pc	\$3.30 / pc
	11	Blue	500pcs	\$3.90 / pc	\$3.80 / pc	\$3.70 / pc
	11	Green	500pcs	\$3.90 / pc	\$3.80 / pc	\$3.70 / pc

**PC Input USB LED Message Fan****▼ Specifications****Product Size:** 33.2cm x 3.3cm x 2.6cm (13" x 1.3" x 1")**Carton Size:** 11.5cm x 5cm x 4.5cm (4.5" x 2" x 1.8")**Product Weight:** 58.6g**Power:** USB**Packing Size:** 54.3cm x 48.8cm x 28cm (21.4" x 19.2" x 11")**Qty / Carton:** 200pcs**N.W.:** 13.72kgs**G.W.:** 15.62kgs**▼ Price List**

Model	Light Qty	Light Color	MOQ	0.5k-1k	1k-2k	2k-3k
FS-SZTB-TBD148-7	7	Red	500pcs	\$3.88 / pc	\$3.85 / pc	\$3.82 / pc
	7	Blue	500pcs	\$4.08 / pc	\$4.03 / pc	\$4.00 / pc
	7	Green	500pcs	\$4.21 / pc	\$4.18 / pc	\$4.15 / pc
FS-SZTB-TBD148-11	11	Red	500pcs	\$4.50 / pc	\$4.40 / pc	\$4.30 / pc
	11	Blue	500pcs	\$4.90 / pc	\$4.80 / pc	\$4.70 / pc
	11	Green	500pcs	\$4.90 / pc	\$4.80 / pc	\$4.70 / pc

## &gt; LED Innovative Products

**3D LED Display Screen**

- Indoor laying 3D full color display screen, it is widely used for the decoration of hotels and exhibitions showcase lighting, the amusement for bars and night show stages with its special 3D animation effects.
- Can display letters, solid figures and pictures with 3D animation effects in 8 x 8 x 8 / 16 x 16 x 16 pixels in an all - directional way.
- Can work synchronous or by SD card controller for its flexibility.
- Creative, flexible, full of imagination and easy to install.

**3D-SEEKWAY-A08****▼ Specifications**

**Product Size:** 25cm x 25cm x 31cm (9.8" x 9.8" x 12.2")

**Voltage:** AC110V-AC230V

**Package:** Carton

**Illuminant:** Highly luminous LED, totally 8 x 8 x 8 + 7 x 7 x 7

**N.W.:** 5kgs

**▼ Price List**

Model	Pixel Qty	Light Color	MOQ	Price
3D-Seekway-A08	512	Full color	1pcs	\$510 / pc

**3D-SEEKWAY-A16****▼ Specifications**

**Product Size:** 70cm x 70cm x 70cm (27.6" x 27.6" x 27.6")

**Voltage:** AC110V-AC230V

**Package:** Aviation box for transportation

**Accessories:** Monitors, power supply, controller and software

**Illuminant:** Highly luminous LED in 16 x 16 x 16 pixels

**N.W.:** 50kgs

**▼ Price List**

Model	Pixel Qty	Light Color	MOQ	Price
3D-Seekway-A16	4096	Full color	1pcs	\$4,550 / pc

**3D-Seekway C08****▼ Specifications**

**Product Size:** 130cm x 122cm x 135cm (51" x 48" x 53")

**Voltage:** AC220V

**Package:** Aviation box for transportation

**Accessories:** Monitors, power supply, controller and software

**Illuminant:** Highly luminous LED in 8 x 8 x 8 pixels

**N.W.:** 20kgs

**▼ Price List**

Model	Pixel Qty	Light Color	MOQ	Price
3D-Seekway C08	512	Full color	1pcs	\$4,200 / pc

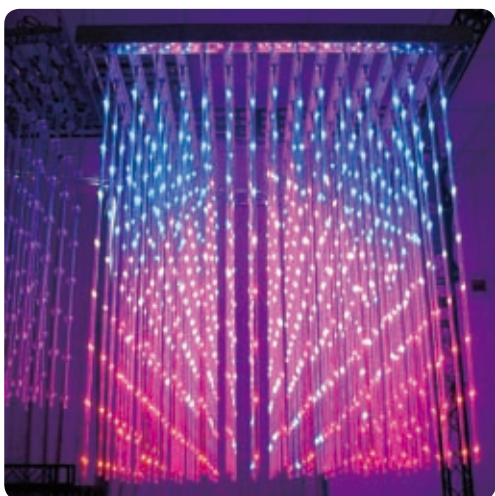



## About LED Screen

The factors you should consider when choosing LED screen:

- Displaying content.
- Best viewing distance and viewing angle.
- Requirement on pixel pitch.
- Setting environment (IP grade).

**Indoors:** With the pixel pitch from 3mm (0.12") to 12mm (0.47"), non - waterproof.

**Outdoors:** With the pixel pitch from 16mm (0.63") to 31.25mm (1.23"), waterproof.

Screen with **low density of pixel** is more suitable for viewing in longer distance.

Screen with **high density of pixel** is more suitable for viewing in shorter distance.

### How to choose the screen with the right size?

- Choosing the screen with the best viewing distance which could match the dimensions of your court (Where you set the screen).
- Choosing the right pixel pitch.
- Reserving enough space for setting and maintaining is necessary.

### How to choose the screen with the right physical density?

- **For displaying characters:** Choosing based on the size of the displaying characters and resolution of module.
- **For displaying common video:** 320 x 240 pixels
- **For displaying standard digital DVD:**  $\geq 640 \times 480$  pixel
- **For displaying computer video:**  $\geq 800 \times 600$  pixel

The requirement on the brightness of environment:

**Indoor:**  $> 800\text{CD} / \text{M}^2$

**Semi outdoor (Indoor but near the window):**  $> 2000\text{CD} / \text{M}^2$

**Outdoor (Facing to the north):**  $> 4000\text{CD} / \text{M}^2$

**Outdoor (Facing to the south):**  $> 8000\text{CD} / \text{M}^2$

You could choose different screens based on your own budget.



## &gt; LED Full Color Screen

**DIP Full Color LED Screen**

Full Color LED Screen - DIP means to drill through the PCB board with the bases of lamps encapsulated by DIP, and fill the lamp hole with tin by welding.

Those manufactured by this technical process are called lamp - inserted displays.

- The DIP LED display screen is of high brightness.
- Good heat dissipation.
- Perfect for outdoor message display.

**P10 LED Dip Lamp Full Color Screen**

## ▼ Price List

Pixel Pitch	MOQ	Use Environment	Unit Price
10mm (0.4")	1m <sup>2</sup>	Outdoor	≤ \$2,000 / m <sup>2</sup>

## ▼ Specifications

Pixel Pitch	10mm (0.4")	Size of Module	160mm x 80mm (6.3" x 3.1")
Resolution of Module	16 x 8	Size of Cabinet	640mm x 480mm x 140mm (25.2" x 18.9" x 5.5")
Resolution of Cabinet	64 x 48	Pixel Configuration	1R1G1B
Density of Pixel	10000dots / m <sup>2</sup>	Green Wavelength	525 ± 2nm
Red Wavelength	625 ± 2nm	Colors	16777216
Blue Wavelength	470 ± 2nm	Horizontal Viewing Angle	120°
Best Viewing Distance	12 - 120m	Brightness	≥ 7000cd / m <sup>2</sup>
Maximum Power Consumption	≤ 2000W / m <sup>2</sup>	Gray Scale	256 levels per color
IP Grade	IP65	Control Method	Synchronization
Color Temperature	6500K	Frame Frequency	60Hz
Driving Method	Constant 1 / 2 scanning	Working Voltage	AC 220V / 110V ± 10%
Refresh Frequency	≥ 300Hz	MTBF	More than 10,000 hours
Working Temperature	-20°C ~ +60°C	Life Span	100,000 hours

**P12 LED Dip Lamp Full Color Screen**

## ▼ Price List

Pixel Pitch	MOQ	Use Environment	Unit Price
12mm (0.5")	1m <sup>2</sup>	Outdoor	≤ \$1,800 / m <sup>2</sup>

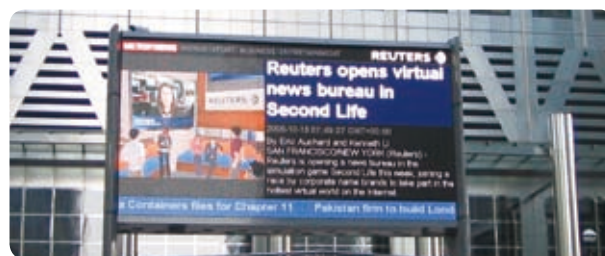

## ▼ Specifications

Pixel Pitch	12mm (0.47")	Size of Module	192mm x 96mm (7.6" x 3.8")
Resolution of Module	16 x 8	Size of Cabinet	768mm x 576mm x 140mm (30" x 22.7" x 5.5")
Resolution of Cabinet	64 x 48	Pixel Configuration	1R1G1B
Density of Pixel	6944dots / m <sup>2</sup>	Green Wavelength	525 ± 2nm
Red Wavelength	625 ± 2nm	Colors	16777216
Blue Wavelength	470 ± 2nm	Horizontal Viewing Angle	120°
Best Viewing Distance	12 - 120m	Brightness	≥ 7000cd / m <sup>2</sup>
Maximum Power Consumption	≤ 2000W / m <sup>2</sup>	Gray Scale	256 levels per color
IP Grade	IP65	Control Method	Synchronization
Color Temperature	6500K	Frame Frequency	60Hz
Driving Method	Constant 1 / 2 Scanning	Working Voltage	AC 220V / 110V ± 10%
Refresh Frequency	≥ 300Hz	MTBF	More than 10,000 hours
Working Temperature	-20°C ~ +60°C	Life Span	100,000 hours

## > LED Full Color Screen

### DIP Full Color LED Screen

Full Color LED Screen - DIP means to drill through the PCB board with the bases of lamps encapsulated by DIP, and fill the lamp hole with tin by welding.

Those manufactured by this technical process are called lamp - inserted displays.

- The DIP LED display screen is with high brightness.
- Good heat dissipation.
- Perfect for outdoor message display.



### P16 LED DIP Lamp Full Color Screen



#### ▼ Price List

Pixel Pitch	MOQ	Use Environment	Unit Price
16mm (0.6")	1m <sup>2</sup>	Outdoor	≤ \$1,500 / m <sup>2</sup>

#### ▼ Specifications

Pixel Pitch	16mm (0.63")	Size of Module	256mm x 256mm (10" x 10")
Resolution of Module	16 x 16	Size of Cabinet	512mm x 512mm x 120mm (20" x 20" x 4.7")
Resolution of Cabinet	32 x 32	Pixel Configuration	1R1G1B
Density of Pixel	3906dots / m <sup>2</sup>	Green Wavelength	525 ± 2nm
Red Wavelength	625 ± 2nm	Colors	16777216
Blue Wavelength	470 ± 2nm	Horizontal Viewing Angle	120°
Best Viewing Distance	15 - 300m	Brightness	≥ 6500cd / m <sup>2</sup>
Maximum Power Consumption	≤ 1200W / m <sup>2</sup>	Gray Scale	256 levels per color
IP Grade	IP65	Control Method	Synchronization
Color Temperature	6500K	Frame Frequency	60Hz
Driving Method	Constant static	Working Voltage	AC 220V / 110V ± 10%
Refresh Frequency	≥ 300Hz	MTBF	More than 10,000 hours
Working Temperature	-20°C ~ +60°C	Life Span	100,000 hours

### P20 LED DIP Lamp Full Color Screen

#### ▼ Price List

Pixel Pitch	MOQ	Use Environment	Unit Price
20mm (0.8")	1m <sup>2</sup>	Outdoor	≤ \$1,350 / m <sup>2</sup>

#### ▼ Specifications

Pixel Pitch	20mm ( 0.8")	Size of Module	320mm x 320mm (12.6" x 12.6")
Resolution of Module	16 x 16	Size of Cabinet	640mm x 640mm x 120mm (25.2" x 25.2" x 4.7")
Resolution of Cabinet	32 x 32	Pixel Configuration	1R1G1B
Density of Pixel	2500 dots / m <sup>2</sup>	Green Wavelength	525 ± 2nm
Red Wavelength	625 ± 2nm	Colors	16777216
Blue Wavelength	470 ± 2nm	Horizontal Viewing Angle	120°
Best viewing Distance	15 - 300m	Brightness	≥ 5500 cd / m <sup>2</sup>
Maximum Power Consumption	≤ 1100W / m <sup>2</sup>	Gray Scale	256 levels per color
IP Grade	IP65	Control Method	Synchronization
Color Temperature	6500K	Frame Frequency	60Hz
Driving Method	Constant static	Working Voltage	AC 220V / 110V ± 10%
Refresh Frequency	≥ 300Hz	MTBF	More than 10,000 hours
Working Temperature	-20°C ~ +60°C	Life Span	100,000 hours

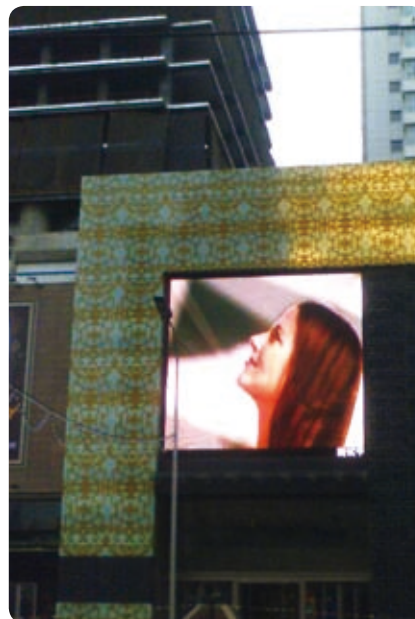

## &gt; LED Full Color Screen

**Integrated Three - in - one Full Color LED Screen**

This series of LED screens are called 3 in 1 Dot Matrix True Color Module LED Screen.

Each pixel of the module is made up of three LED chips (high brightness pure red and pure green and pure blue), they are bound by Ultrasonic AI Wire Bonder and each module is composed of 4 x 4 or 8 x 8 pixels.

- Big range viewing angle
- Excellent brightness
- Vivid color
- Long service life
- Low consumption of energy
- Flexible installation methods

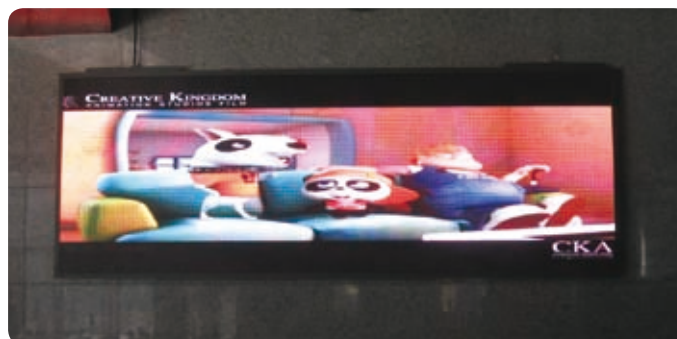
**P7.62 Three - in - one Full Color LED Screen**

## ▼ Price List

Pixel Pitch	MOQ	Use Environment	Unit Price
7.62mm ( 0.3")	1m <sup>2</sup>	Indoor	≤ \$1,600 / m <sup>2</sup>

## ▼ Specifications

<b>Pixel Pitch</b>	7.62mm ( 0.3")	<b>Size of Pixel</b>	4mm (0.16") (Circle)
<b>Size of Block Module</b>	30.2mm x 30.2mm (1.2" x 1.2")	<b>Pixel of Block Module</b>	4 x 4 / 8 x 8
<b>Size of Module</b>	488mm x 244mm (19" x 9.6")	<b>Resolution of Module</b>	64 x 32
<b>Size of Cabinet</b>	976mm x 488mm x 120mm (38.4" x 19.2" x 4.7")	<b>Resolution of cabinet</b>	128 x 64
<b>Area of Cabinet</b>	0.0572 m <sup>2</sup>	<b>Density of Pixel</b>	17222dots / m <sup>2</sup>
<b>Pixel Configuration</b>	1R1PG1B	<b>Best Viewing Distance</b>	9m - 26m
<b>Brightness</b>	> 1200cd / m <sup>2</sup>	<b>Maximum Power Consumption</b>	< 700W / m <sup>2</sup>
<b>Horizontal Viewing Angle</b>	140°	<b>IP Grade</b>	IP20
<b>Driving Device</b>	Constant current	<b>Driving Method</b>	1 / 8 / or 1 / 4 scanning
<b>Colors</b>	16777216	<b>Color Temperature</b>	6500K
<b>Gray Scale</b>	14 bits	<b>Refresh Frequency</b>	≥ 180Hz
<b>Control Method</b>	Synchronization	<b>Working Temperature</b>	-10°C ~ +45°C
<b>Frame Frequency</b>	≥ 60Hz	<b>MTBF</b>	> 10,000 hours
<b>Working Voltage</b>	AC 220V / 110V ± 10%	<b>Life Span</b>	100,000 hours

**P8 Three-in-one Full Color LED Screen**

## ▼ Price List

Pixel Pitch	MOQ	Use Environment	Unit Price
8mm (0.31")	1m <sup>2</sup>	Indoor	≤ \$1,900 / m <sup>2</sup>



## ▼ Specifications

<b>Pixel Pitch</b>	8mm (0.31")	<b>Size of Pixel</b>	3mm x 4mm (0.12" x 0.16") (Ellipse)
<b>Size of Block Module</b>	32mm x 32mm (1.3" x 1.3")	<b>Pixel of Block Module</b>	4 x 4
<b>Size of Module</b>	512mm x 256mm (20" x 20")	<b>Resolution of Module</b>	64 x 32
<b>Size of Cabinet</b>	1024mm x 768mm x 120mm (40" x 30" x 4.7")	<b>Resolution of Cabinet</b>	128 x 64
<b>Area of Cabinet</b>	0.0944 m <sup>2</sup>	<b>Density of Pixel</b>	15625dots / m <sup>2</sup>
<b>Pixel Configuration</b>	1R1PG1B	<b>Best Viewing Distance</b>	10m - 27m
<b>Brightness</b>	> 1800cd / m <sup>2</sup>	<b>Maximum Power Consumption</b>	< 600W / m <sup>2</sup>
<b>Horizontal Viewing Angle</b>	140°	<b>IP Grade</b>	IP20
<b>Driving Device</b>	Constant current	<b>Driving Method</b>	1 / 8 / or 1 / 4 scanning
<b>Colors</b>	16777216	<b>Color Temperature</b>	6500K
<b>Gray Scale</b>	14 bits	<b>Refresh Frequency</b>	≥ 180Hz
<b>Control Method</b>	Synchronization	<b>Working Temperature</b>	-10°C ~ +45°C
<b>Frame Frequency</b>	≥ 60Hz	<b>MTBF</b>	> 10,000 hours
<b>Working Voltage</b>	AC 220V / 110V ± 10%	<b>Life Span</b>	100,000 hours

## &gt; LED Scrolling Sign

**Indoor LED Scrolling Sign**

- This Indoor LED scrolling message sign board has everything in the box to start advertising.
- The message board is light weight, easy to move and program, and has various animation and transition effects, with 12 months warranty.
- You can connect the sign to your desktop or a laptop to program the messages, add animation effects and graphics or change the font.
- What's more, you can enjoy our one - stop service by ordering LED signs online from our shop, getting it delivered directly to your doorstep.



## ▼ Price List

Model	Color	Pixel	Min Font-height	Max. Qty / Line	Product Size (L x H x T)	Unit Price
F760A	Red / Green / Yellow	7 x 60	2"	10	502mm x 89mm x 40mm (20" x 3.5" x 1.6")	≤ \$95
F780A	Red / Green / Yellow	7 x 80	2"	15	655mm x 89mm x 40mm (26" x 3.5" x 1.6")	≤ \$112
F795A	Red / Green / Yellow	7 x 95	2"	16	769mm x 89mm x 40mm (30" x 3.5" x 1.6")	≤ \$129
F7120A	Red / Green / Yellow	7 x 120	2"	20	958mm x 89mm x 40mm (38" x 3.5" x 1.6")	≤ \$150
F1664A	Red / Green / Yellow	16 x 64	2"	10	518mm x 142mm x 40mm (20" x 5.6" x 1.6")	≤ \$127
F1696A	Red / Green / Yellow	16 x 96	2"	16	762mm x 142mm x 40mm (30" x 5.6" x 1.6")	≤ \$155
F16128A	Red / Green / Yellow	16 x 128	2"	21	1006mm x 142mm x 40mm (40" x 5.6" x 1.6")	≤ \$169
F16160A	Red / Green / Yellow	16 x 160	2"	26	1250mm x 142mm x 40mm (49" x 5.6" x 1.6")	≤ \$199
F16192A	Red / Green / Yellow	16 x 192	2"	32	1494mm x 142mm x 40mm (59" x 5.6" x 1.6")	≤ \$226
F16224A	Red / Green / Yellow	16 x 224	2"	37	1738mm x 142mm x 40mm (68" x 5.6" x 1.6")	≤ \$269
F16256A	Red / Green / Yellow	16 x 256	2"	42	1982mm x 142mm x 40mm (78" x 5.6" x 1.6")	≤ \$295
F1664S	Red	16 x 64	2"	10	518mm x 142mm x 40mm (20" x 5.6" x 1.6")	≤ \$119
F1696S	Red	16 x 96	2"	16	762mm x 142mm x 40mm (30" x 5.6" x 1.6")	≤ \$142
F16128S	Red	16 x 128	2"	21	1006mm x 142mm x 40mm (40" x 5.6" x 1.6")	≤ \$148
F16160S	Red	16 x 160	2"	26	1250mm x 142mm x 40mm (49" x 5.6" x 1.6")	≤ \$181
F16192S	Red	16 x 192	2"	32	1494mm x 142mm x 40mm (59" x 5.6" x 1.6")	≤ \$203
F16224S	Red	16 x 224	2"	37	1738mm x 142mm x 40mm (68" x 5.6" x 1.6")	≤ \$236
F16256S	Red	16 x 256	2"	42	1982mm x 142mm x 40mm (78" x 5.6" x 1.6")	≤ \$265
F2464A	Red / Green / Yellow	24 x 64	2"	10	533mm x 228mm x 70mm (21" x 9" x 2.8")	≤ \$158
F24128A	Red / Green / Yellow	24 x 128	2"	21	1021mm x 228mm x 70mm (40" x 9" x 2.8")	≤ \$223
F24160A	Red / Green / Yellow	24 x 160	2"	26	1265mm x 228mm x 70mm (50" x 9" x 2.8")	≤ \$270
F24192A	Red / Green / Yellow	24 x 192	2"	32	1509mm x 228mm x 70mm (59" x 9" x 2.8")	≤ \$294
F24224A	Red / Green / Yellow	24 x 224	2"	37	1753mm x 228mm x 70mm (69" x 9" x 2.8")	≤ \$339
F24256A	Red / Green / Yellow	24 x 256	2"	42	1997mm x 228mm x 70mm (79" x 9" x 2.8")	≤ \$357
F2464S	Red	24 x 64	2"	10	533mm x 228mm x 70mm (21" x 9" x 2.8")	≤ \$146
F24128S	Red	24 x 128	2"	21	1021mm x 228mm x 70mm (40" x 9" x 2.8")	≤ \$199
F24160S	Red	24 x 160	2"	26	1265mm x 228mm x 70mm (50" x 9" x 2.8")	≤ \$238
F24192S	Red	24 x 192	2"	32	1509mm x 228mm x 70mm (59" x 9" x 2.8")	≤ \$258
F24224S	Red	24 x 224	2"	37	1753mm x 228mm x 70mm (69" x 9" x 2.8")	≤ \$295
F24256S	Red	24 x 256	2"	42	1997mm x 228mm x 70mm (79" x 9" x 2.8")	≤ \$309

## &gt; LED Scrolling Sign

**Indoor LED Scrolling Sign**

- This Indoor LED scrolling message sign board has everything in the box to start advertising.
- The message board is light weight, easy to move and program. It has various animation and transition effects, with 12 months warranty.
- You can connect the sign to your desktop or laptop to program the messages, add animation effects and graphics or change the font.
- What's more, you can enjoy our one - stop service by ordering LED signs online from our shop, getting it delivered directly to your doorstep.



## ▼ Price List

Model	Color	Pixel	Min Font-height	Max. Qty / Line	Product Size (L x H x T)	Unit Price
F3264A	Red / Green / Yellow	32 x 64	2"	10	533mm x 289mm x 70mm (21" x 11" x 2.8")	≤ \$179
F32128A	Red / Green / Yellow	32 x 128	2"	21	1021mm x 289mm x 70mm (40" x 11" x 2.8")	≤ \$260
F32160A	Red / Green / Yellow	32 x 160	2"	26	1265mm x 289mm x 70mm (50" x 11" x 2.8")	≤ \$321
F32192A	Red / Green / Yellow	32 x 192	2"	32	1509mm x 289mm x 70mm (59" x 11" x 2.8")	≤ \$347
F32224A	Red / Green / Yellow	32 x 224	2"	37	1753mm x 289mm x 70mm (69" x 11" x 2.8")	≤ \$403
F32256A	Red / Green / Yellow	32 x 256	2"	42	1997mm x 289mm x 70mm (79" x 11" x 2.8")	≤ \$428
F3264S	Red	32 x 64	2"	10	558mm x 314mm x 90mm (22" x 12" x 3.5")	≤ \$162
F32128S	Red	32 x 128	2"	21	1045mm x 314mm x 90mm (41" x 12" x 3.5")	≤ \$220
F32160S	Red	32 x 240	2"	26	1290mm x 314mm x 90mm (51" x 12" x 3.5")	≤ \$279
F32192S	Red	32 x 192	2"	32	1533mm x 314mm x 90mm (60" x 12" x 3.5")	≤ \$296
F32224S	Red	32 x 224	2"	37	1777mm x 314mm x 90mm (70" x 12" x 3.5")	≤ \$343
F32256S	Red	32 x 256	2"	42	2021mm x 314mm x 90mm (80" x 12" x 3.5")	≤ \$360
D1680A	Red / Green / Yellow	16 x 80	1.5"	13	410mm x 120mm x 34mm (16" x 4.7" x 1.3")	≤ \$107
D1696A	Red / Green / Yellow	16 x 96	1.5"	16	486mm x 120mm x 34mm (19" x 4.7" x 1.3")	≤ \$131
D16128A	Red / Green / Yellow	16 x 128	1.5"	21	638mm x 120mm x 34mm (25" x 4.7" x 1.3")	≤ \$148
D16160A	Red / Green / Yellow	16 x 160	1.5"	26	700mm x 120mm x 34mm (28" x 4.7" x 1.3")	≤ \$159
D16240A	Red / Green / Yellow	16 x 240	1.5"	40	1170mm x 120mm x 34mm (46" x 4.7" x 1.3")	≤ \$210
D1680S	Red	16 x 80	1.5"	13	410mm x 120mm x 34mm (16" x 4.7" x 1.3")	≤ \$102
D1696S	Red	16 x 96	1.5"	16	486mm x 120mm x 34mm (19" x 4.7" x 1.3")	≤ \$125
D16128S	Red	16 x 128	1.5"	21	638mm x 120mm x 34mm (25" x 4.7" x 1.3")	≤ \$139
D16160S	Red	16 x 160	1.5"	26	700mm x 120mm x 34mm (28" x 4.7" x 1.3")	≤ \$151
D16240S	Red	16 x 240	1.5"	40	1170mm x 120mm x 34mm (46" x 4.7" x 1.3")	≤ \$194
D3264A	Red / Green / Yellow	32 x 64	1.5"	10	349mm x 197mm x 70mm (14" x 8" x 2.8")	≤ \$145
D32128A	Red / Green / Yellow	32 x 128	1.5"	21	653mm x 197mm x 70mm (26" x 8" x 2.8")	≤ \$203
D32192A	Red / Green / Yellow	32 x 192	1.5"	32	912mm x 197mm x 70mm (36" x 8" x 2.8")	≤ \$266
D32256A	Red / Green / Yellow	32 x 256	1.5"	42	1261mm x 197mm x 70mm (50" x 8" x 2.8")	≤ \$316
D3264S	Red	32 x 64	1.5"	10	349mm x 197mm x 70mm (14" x 8" x 2.8")	≤ \$136
D32128S	Red	32 x 128	1.5"	21	653mm x 197mm x 70mm (26" x 8" x 2.8")	≤ \$186
D32192S	Red	32 x 192	1.5"	32	912mm x 197mm x 70mm (36" x 8" x 2.8")	≤ \$240
D32256S	Red	32 x 256	1.5"	42	1261mm x 197mm x 70mm (50" x 8" x 2.8")	≤ \$280

## &gt; LED Scrolling Sign



## Semi Outdoor LED Scrolling Sign

- This Semi Outdoor LED scrolling sign are ideal for advertising your shop weekly specials, lunch time deals and other promotions in your store.
- There are two options to program the Semi Outdoor Scrolling Message Sign. You can use the fully programmable remote control to store and update messages or connect the LED sign to your desktop or laptop and transmit the messages.
- It comes with more than 20 transition effects and can be programmed to display messages using big fonts in one line or small fonts in two lines.
- Within 12 months warranty and maintenance free, you can buy this LED signs with confidence.



## ▼ Price List

Model	Color	Pixel	Min Font-height	Max. Qty / Line	Product Size (L x H x T)	Unit Price
F760R	Red	7 x 60	2"	10	502mm x 89mm x 40mm (20" x 3.5" x 1.6")	≤ \$95
F780R	Red	7 x 80	2"	15	655mm x 89mm x 40mm (26" x 3.5" x 1.6")	≤ \$112
F795R	Red	7 x 95	2"	16	769mm x 89mm x 40mm (30" x 3.5" x 1.6")	≤ \$129
F7120R	Red	7 x 120	2"	20	958mm x 89mm x 40mm (38" x 3.5" x 1.6")	≤ \$150
F760B	Blue	7 x 60	2"	10	502mm x 89mm x 40mm (20" x 3.5" x 1.6")	≤ \$106
F780B	Blue	7 x 80	2"	15	655mm x 89mm x 40mm (26" x 3.5" x 1.6")	≤ \$121
F795B	Blue	7 x 95	2"	16	769mm x 89mm x 40mm (30" x 3.5" x 1.6")	≤ \$140
F7120B	Blue	7 x 120	2"	20	958mm x 89v x 40mm (38" x 3.5" x 1.6")	≤ \$159
F1664R	Red	16 x 64	2"	10	518mm x 142mm x 40mm (20" x 5.6" x 1.6")	≤ \$132
F1696R	Red	16 x 96	2"	16	762mm x 142mm x 40mm (30" x 5.6" x 1.6")	≤ \$161
F16128R	Red	16 x 128	2"	21	1006mm x 142mm x 40mm (40" x 5.6" x 1.6")	≤ \$182
F16160R	Red	16 x 160	2"	26	1250mm x 142mm x 40mm (49" x 5.6" x 1.6")	≤ \$208
F16192R	Red	16 x 192	2"	32	1494mm x 142mm x 40mm (59" x 5.6" x 1.6")	≤ \$256
F16224R	Red	16 x 224	2"	37	1738mm x 142mm x 40mm (68" x 5.6" x 1.6")	≤ \$292
F16256R	Red	16 x 256	2"	42	1982mm x 142mm x 40mm (78" x 5.6" x 1.6")	≤ \$329
F1664RG	Red / Green / Yellow	16 x 64	2"	10	518mm x 142mm x 40mm (20" x 5.6" x 1.6")	≤ \$154
F1696RG	Red / Green / Yellow	16 x 96	2"	16	762mm x 142mm x 40mm (30" x 5.6" x 1.6")	≤ \$191
F16128RG	Red / Green / Yellow	16 x 128	2"	21	1006mm x 142mm x 40mm (40" x 5.6" x 1.6")	≤ \$225
F16160RG	Red / Green / Yellow	16 x 160	2"	26	1250mm x 142mm x 40mm (49" x 5.6" x 1.6")	≤ \$270
F16192RG	Red / Green / Yellow	16 x 192	2"	32	1494mm x 142mm x 40mm (59" x 5.6" x 1.6")	≤ \$316
F16224RG	Red / Green / Yellow	16 x 224	2"	37	1738mm x 142mm x 40mm (68" x 5.6" x 1.6")	≤ \$363
F16256RG	Red / Green / Yellow	16 x 256	2"	42	1982mm x 142mm x 40mm (78" x 5.6" x 1.6")	≤ \$410
F2464R	Red	24 x 64	2"	10	533mm x 228mm x 70mm (21" x 9" x 2.8")	≤ \$166
F24128R	Red	24 x 128	2"	21	1021mm x 228mm x 70mm (40" x 9" x 2.8")	≤ \$245
F24160R	Red	24 x 160	2"	26	1265mm x 228mm x 70mm (50" x 9" x 2.8")	≤ \$288
F24192R	Red	24 x 192	2"	32	1509mm x 228mm x 70mm (59" x 9" x 2.8")	≤ \$316
F24224R	Red	24 x 224	2"	37	1753mm x 228mm x 70mm (69" x 9" x 2.8")	≤ \$365
F24256R	Red	24 x 256	2"	42	1997mm x 228mm x 70mm (79" x 9" x 2.8")	≤ \$387
F2464RG / B	R / G / Y or Blue	24 x 64	2"	10	533mm x 228mm x 70mm (21" x 9" x 2.8")	≤ \$198
F24128RG / B	R / G / Y or Blue	24 x 128	2"	21	1021mm x 228mm x 70mm (40" x 9" x 2.8")	≤ \$308
F24160RG / B	R / G / Y or Blue	24 x 160	2"	26	1265mm x 228mm x 70mm (50" x 9" x 2.8")	≤ \$368
F24192RG / B	R / G / Y or Blue	24 x 192	2"	32	1509mm x 228mm x 70mm (59" x 9" x 2.8")	≤ \$411
F24224RG / B	R / G / Y or Blue	24 x 224	2"	37	1753mm x 228mm x 70mm (69" x 9" x 2.8")	≤ \$476
F24256RG / B	R / G / Y or Blue	24 x 256	2"	42	1997mm x 228mm x 70mm (79" x 9" x 2.8")	≤ \$514
F3264R	Red	32 x 64	2"	10	558mm x 314mm x 90mm (22" x 12" x 3.5")	≤ \$187
F32128R	Red	32 x 128	2"	21	1045mm x 314mm x 90mm (41" x 12" x 3.5")	≤ \$278
F32160R	Red	32 x 160	2"	26	1290mm x 314mm x 90mm (51" x 12" x 3.5")	≤ \$343
F32192R	Red	32 x 192	2"	32	1533mm x 314mm x 90mm (60" x 12" x 3.5")	≤ \$372
F32224R	Red	32 x 224	2"	37	1777mm x 314mm x 90mm (70" x 12" x 3.5")	≤ \$433
F32256R	Red	32 x 256	2"	42	2021mm x 314mm x 90mm (80" x 12" x 3.5")	≤ \$462
F3264RG / B	R / G / Y or Blue	32 x 64	2"	10	558mm x 314mm x 90mm (22" x 12" x 3.5")	≤ \$236
F32128RG / B	R / G / Y or Blue	32 x 128	2"	21	1045mm x 314mm x 90mm (41" x 12" x 3.5")	≤ \$363
F32160RG / B	R / G / Y or Blue	32 x 160	2"	26	1290mm x 314mm x 90mm (51" x 12" x 3.5")	≤ \$449
F32192RG / B	R / G / Y or Blue	32 x 192	2"	32	1533mm x 314mm x 90mm (60" x 12" x 3.5")	≤ \$500
F32224RG / B	R / G / Y or Blue	32 x 224	2"	37	1777mm x 314mm x 90mm (70" x 12" x 3.5")	≤ \$583
F32256RG / B	R / G / Y or Blue	32 x 256	2"	42	2021mm x 314mm x 90mm (80" x 12" x 3.5")	≤ \$632

## &gt; LED Modules

This LED SMD module is widely used for solid lighting character, LED signs, LED lighting box, scenery designs and decor, etc.

- Using high brightness LED SMD as the lamp - house, having wide viewing angle and petty aperture.
- Controlled by the chips with constant current, having constant working current and indiscriminate between the cathode and anode.
- With a settled orifice and 3M gummed paper, very convenient to install.
- Long life time: Above 80000hrs.
- Low power consumption, energy conservation and saving electricity.



### Waterproof LED Module, SMD 5050, 3LEDs, White light, 74mm x 12mm (2.9" x 0.47")



## ▼ Price List

Model	MOQ	Color	Unit Price
LEDM-LBY-507412-3CWF	100pcs	Warm White / Pure White / Cool White	≤ \$0.61

## ▼ Specifications

<b>Color</b>	Red, Yellow, Blue, Green, White	<b>LED type</b>	5050 SMD
<b>LED Qty</b>	3pcs	<b>Dimension</b>	74mm x 12mm x 6mm (2.9" x 0.47" x 0.24")
<b>Module Interface</b>	2 x 0.5 sq. mm x 75mm (2.9") RV leads	<b>Interface Definition</b>	Gray anode, white cathode
<b>Cluster Qty</b>	20pcs	<b>Module Space Between</b>	75mm (2.9")
<b>Weight</b>	10g ± 5%	<b>Life Span</b>	MTBF > 50000hours
<b>Environment Parameter</b>			
<b>Working Temperature</b>	-40°C ~ 60°C		
<b>Defend Grade</b>	IP65 completely satisfied the outdoor lighting standard		
<b>Electronic Specification</b>			
<b>Working Input Voltage</b>	D12V ± 5%	<b>Max. Power</b>	0.63W
<b>Driving Mode</b>	Invariableness Voltage (Insure every LED working under the invariableness voltage)		
<b>Lighting Capability</b>			
<b>Luminous Flux</b>	54lm		
<b>Beam Angle</b>	120°		

### SMD 2835 LED Module Waterproof, 3 LEDs, White light, L70mm x W16mm x H5mm (2.8" x 0.63" x 0.24")

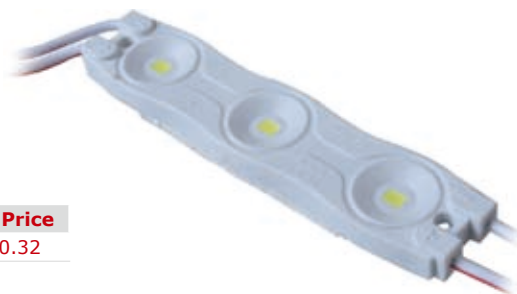

## ▼ Price List

Model	MOQ	Color	Unit Price
LEDM-GKL-MFX146A	100pcs	Warm White / Pure White / Cool White	≤ \$0.32

## ▼ Specifications

<b>Color</b>	Red ,White	<b>LED Type</b>	2835SMD
<b>LED Qty</b>	3pcs	<b>Dimension</b>	70mm x 16mm x 6mm (2.8" x 0.63" x 0.24")
<b>Module Interface</b>	2 x 0.5 sq. mm x 80mm (3.15") RV leads	<b>Interface Definition</b>	Gray anode, white cathode
<b>Cluster Qty</b>	20pcs	<b>Module Space Between</b>	80mm (3.15")
<b>Weight</b>	10g ± 5%	<b>Life Span</b>	MTBF> 50000hours
<b>Environment Parameter</b>			
<b>Working Temperature</b>	-40°C ~ 60°C		
<b>Defend Grade</b>	IP65 completely satisfied the outdoor lighting standard		
<b>Electronic Specification</b>			
<b>Working Input Voltage</b>	D12V ± 5%	<b>Max. Power</b>	0.72W
<b>Driving Mode</b>	Invariableness Voltage! (Insure every LED working under the invariableness voltage)		
<b>Lighting Capability</b>			
<b>Luminous Flux</b>	66lm		
<b>Beam Angle</b>	140°		



## > LED Modules

This LED SMD module is widely used for solid lighting character, LED signs, LED lighting box, scenery designs and decor, etc.

- Using high brightness LED SMD as the lamp - house, having wide viewing angle and petty aperture.
- Controlled by the chips with constant current, having constant working current and indiscriminate between the cathode and anode.
- With a settled orifice and 3M gummed paper, very convenient to install.
- Long life time: Above 80000hrs.
- Low power consumption, energy conservation and saving electricity.

### High Power 3 SMD Waterproof LED Module, White LED, 1.44W, 44mm x 43mm (1.7" x 1.7")

#### ▼ Price List

Model	MOQ	Color	Unit Price
LEDMODULE-CM-IEW340B	60pcs	Pure White / Cool White	≤ \$1.39

#### ▼ Specifications

<b>Color</b>	Pure White / Cool White		<b>LED Type</b>	5730 SMD
<b>LED Qty</b>	3pcs		<b>Dimension</b>	44mm x 43mm (1.7" x 1.7")
<b>Module Interface</b>	26# line red & white wires, negative wires length:260mm,red +, white -		<b>Interface Definition</b>	Red anode, white cathode
<b>Cluster Qty</b>	30pcs		<b>Module Space Between</b>	260mm(10")
<b>Weight</b>	20g ± 5%		<b>Life Span</b>	MTBF> 50000hours
<b>Environment Parameter</b>				
<b>Working Temperature</b>	-40°C ~ 50°C			
<b>Defend Grade</b>	IP67 completely satisfied the outdoor lighting standard			
<b>Electronic Specification</b>				
<b>Working Input Voltage</b>	D12V ± 5%	<b>Max. Power</b>	1.44W	
<b>Driving Mode</b>	Constant current driving			
<b>Lighting Capability</b>				
<b>Luminous Flux</b>	120lm			
<b>Beam Angle</b>	120°			



### 3 SMD Waterproof LED Module, 0.3W, White LED, 74x12.4mm (3" x 0.49")

#### ▼ Price List

Model	MOQ	Color	Unit Price
LEDM-RS-M613B-3WF	100pcs	Warm White / Pure White / Cool White	≤ \$0.43

#### ▼ Specifications

<b>Color</b>	Warm White / Pure White / Cool White		<b>LED Type</b>	3528 SMD
<b>LED Qty</b>	3pcs		<b>Dimension</b>	74mm x 12mm x 6mm (3" x 0.49" x 0.24")
<b>Module Interface</b>	2 x 75mm (3") RV leads		<b>Interface Definition</b>	Red+, White-
<b>Cluster Qty</b>	100pcs		<b>Module Space Between</b>	60mm (2.4") ± 5%
<b>Weight</b>	10g ± 5%		<b>Life Span</b>	MTBF> 50000hours
<b>Environment Parameter</b>				
<b>Working Temperature</b>	-40°C ~ 60°C			
<b>Defend Grade</b>	IP65 completely satisfied the outdoor lighting standard			
<b>Electronic Specification</b>				
<b>Working Input Voltage</b>	D12V ± 5%	<b>Max. Power</b>	0.3W	
<b>Driving Mode</b>	Invariableness Voltage! (Insure every LED working under the invariableness voltage)			
<b>Lighting Capability</b>				
<b>Luminous Flux</b>	21lm			
<b>Beam Angle</b>	118°			



## &gt; LED Modules

This LED SMD module is widely used for solid lighting character, LED signs, LED lighting box, scenery designs and décor, etc.

- Using high brightness LED SMD as the lamp - house, having wide viewing angle and petty aperture.
- Controlled by the chips with constant current, having constant working current and indiscriminate between the cathode and anode.
- With a settled orifice and 3M gummed paper, very convenient to install.
- Long life time: Above 80000hrs.
- Low power consumption, energy conservation and saving electricity.

### Waterproof LED Module, SMD 3528, 2LEDs, White light, 26mm x 7mm (1" x 0.2")

#### ▼ Price List

Model	MOQ	Color	Unit Price
LEDM-LBY-352607-2CWF	100pcs	Worm White / Pure White / Cool White	≤ \$0.26



#### ▼ Specifications

<b>Color</b>	Worm White / Pure White / Cool White		<b>LED Type</b>	3528 SMD
<b>LED Qty</b>	2pcs		<b>Dimension</b>	26mm x 7mm x 5mm (1" x 0.2" x 0.2")
<b>Module Interface</b>	2 x 0.5 sq. mm x 75mm (2.9") RV leads		<b>Interface Definition</b>	Gray anode, white cathode
<b>Cluster Qty</b>	20pcs		<b>Module Space Between</b>	75mm (3")
<b>Weight</b>	10g ± 5%		<b>Life Span</b>	MTBF> 50000hours
<b>Environment Parameter</b>				
<b>Working Temperature</b>	-40°C ~ 60°C			
<b>Defend Grade</b>	IP65 completely satisfied the outdoor lighting standard			
<b>Electronic Specification</b>				
<b>Working Input Voltage</b>	D12V ± 5%		<b>Max. Power</b>	0.14W
<b>Driving Mode</b>	Invariableness Voltage! (Insure every LED working under the invariableness voltage)			
<b>Lighting Capability</b>				
<b>Luminous Flux</b>			12lm	
<b>Beam Angle</b>			120°	

### Waterproof LED Module, SMD 5050, 4LEDs, Metal shell, White Light, 35mm x 35mm (1.4" x 1.4")

#### ▼ Price List

Model	MOQ	Color	Unit Price
LEDM-LBY-503535-4CWF	100pcs	Worm White / Pure White / Cool White	≤ \$0.6

#### ▼ Specifications

<b>Color</b>	Worm White / Pure White / Cool White		<b>LED Type</b>	5050 SMD
<b>LED Qty</b>	4pcs		<b>Demension</b>	35mm x 35mm (1.4" x 1.4")
<b>Module Interface</b>	2 x 0.5 sq. mm x 75mm (2.9") RV leads		<b>Interface Definition</b>	Gray anode, white cathode
<b>Cluster Qty</b>	20pcs		<b>Module Space Between</b>	75mm (3")
<b>Weight</b>	10g ± 5%		<b>Life Span</b>	MTBF> 50000hours
<b>Environment Parameter</b>				
<b>Working Temperature</b>	-40°C ~ 60°C			
<b>Defend Grade</b>	IP65 completely satisfied the outdoor lighting standard			
<b>Electronic Specification</b>				
<b>Working Input Voltage</b>	D12V ± 5%		<b>Max. Power</b>	0.84W
<b>Driving Mode</b>	Invariableness Voltage (Insure every LED working under the invariablevoltage)			
<b>lighting capability</b>				
<b>Luminous Flux</b>			72lm	
<b>Beam Angle</b>			120°	

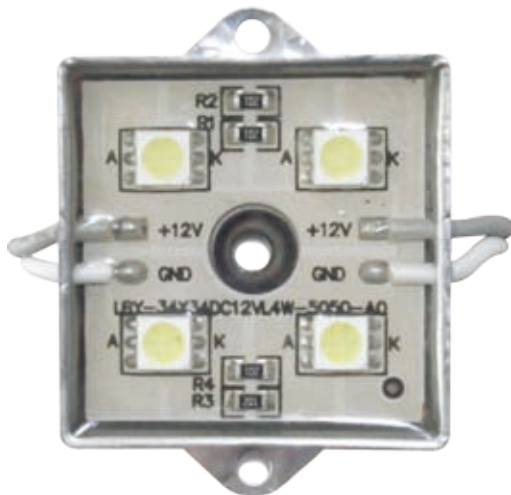

**DS-LEDCPLR-6M-144: LED Clawed Light String**

6M length, 144LEDs

1.5M 2 x 0.75sqm lead cable with DN005 outdoor plug, 3A AC / DC, connectable 230V, 9.2W

**▼ Specifications**

Model	Inner Box	PCS / CTN	Export CTN	N.W.	G.W.	Unit Price
LEDCPLR-6M-144	28 x 20 x 18cm	10	42.5 x 42 x 30cm	12.5kg	13.5kg	≤ \$23.15

This quotation is average price of different colors, and there are differences among the prices. Please visit our website [www.Sign-in-China.com](http://www.Sign-in-China.com) to get details for reference.

**DS-LEDPLR Series LED Curtain Light**

Outdoor and indoor use. Packed by colorful carton.

This curtain light can be used in the building wall, window and other similar places for decoration.

**▼ Product Highlights**

- Multi - Fix compatible
- Brilliant shine LED light
- Low heat emission
- Low power consumption
- Super long life - span
- **Protection Class:** IP44
- **Eight colors are available:** Red, Yellow, Amber, Blue, Green, White, Warm white, Pink.

**▼ Models****DS-LEDPLR-3813-456**

20 strings, 1.5M / string, 2M main cable, 19 LEDs / string, totaled 456LEDs, with sealed cap.  
1.5M lead cable with DN005 outdoor plug, 3A AC / DC, connectable. 230V, 27.6W.

**DS-LEDPLR-3825-912**

24 strings, 3M / string, 2M main cable, 38 LEDs / string, totaled 912LEDs, with sealed cap.  
1.5M lead cable with DN005 outdoor plug, 3A AC / DC, connectable. 230V, 55.2W.

**DS-LEDPLR-5325-1272**

24 strings, 5M / string, 2M main cable, 38 LEDs / string, totaled 1272LEDs, with sealed cap.  
1.5M lead cable with DN005 outdoor plug, 3A AC / DC, connectable. 230V, 110.4W.

**DS-LEDPLR-2015-300**

20 strings, 1.5M / string, 2M main cable, 15 LEDs / string, totaled 300 LEDs, with sealed cap.  
1.5M lead cable with DN005 outdoor plug, 3A AC / DC, connectable. 230V, 46W.

**DS-LEDPLR-2030-600**

20 strings, 3M / string, 2M main cable, 30 LEDs / string, totaled 600LEDs, with sealed cap.  
1.5M lead cable with DN005 outdoor plug, 3A AC / DC, connectable. 230V, 92W.

**DS-LEDPLR-7620-1520**

20 strings, 7M / string, 2M main cable, 76 LEDs / string, totaled 1520 LEDs, with sealed cap.  
1.5M lead cable with DN005 outdoor plug, 3A AC / DC, connectable. 230V, 92W.

**▼ Specifications**

Model	Inner Box	PCS / CTN	Export CTN	N.W.	G.W.	Unit Price
DS-LEDPLR-3813-456	38 x 28 x 12cm	6	58.5 x 40 x 30cm	23.7kg	24.9kg	≤ \$71.55
DS-LEDPLR-3825-912	38 x 28 x 17cm	3	53.5 x 40 x 30cm	16.2kg	17.4kg	≤ \$129.45
DS-LEDPLR-5325-1272	38 x 28 x 26cm	2	54.5 x 40 x 30cm	16.6kg	17.8kg	≤ \$178.50
DS-LEDPLR-1520-300	38 x 28 x 12cm	6	58.5 x 40 x 30cm	22.7kg	23.9kg	≤ \$204.92
DS-LEDPLR-3020-600	38 x 28 x 17cm	3	53.5 x 40 x 30cm	15.2kg	16.4kg	≤ \$55.16
DS-LEDPLR-7620-1520	38 x 28 x 26cm	2	54.5 x 40 x 30cm	18.3kg	19.5kg	≤ \$98.10

This quotation is average price of different colors, and there are differences among the prices. Please visit our website [www.Sign-in-China.com](http://www.Sign-in-China.com) to get details for reference.

## &gt; Decorative Light &gt; Decorative light

**DS-LEDCPLR Series LED Clawed Curtain Light**

Outdoor and indoor use. Packaged in colorful carton.

This curtain light may be used in the building wall, window, stage and other similar places' decoration.

**▼ Specifications**

Model	Inner Box	PCS / CTN	Export CTN	N.W.	G.W.	Unit Price
DS-LEDCPLR-2x2M-480	38 x 28 x 17cm	3	53.5 x 40 x 30cm	14.8kg	16kg	≤ \$69.47
DS-LEDCPLR-2x4M-864	38 x 28 x 26cm	2	54.5 x 40 x 30cm	16.7kg	17.9kg	≤ \$120.00

This quotation is average price of different colors, and there are differences among the prices.

Please visit our website [www.Sign-in-China.com](http://www.Sign-in-China.com) to get details for reference.

**▼ Product Highlights**

- Special clawed design
- Multi - Fix compatible
- Brilliant shine LED light
- Low heat emission
- Low power consumption
- Super long life - span
- **Protection Class:** IP44
- There are eight colors (Red, Yellow, Amber, Blue, Green, White, Warm white, Pink).

**▼ Models****DS-LEDCPLR-2M-480**

2 x 2M, 12 strings, 2M / string, 40 LEDs / string, totaled 480 LEDs, with sealed cap. 1.5M 2 x 0.75sqm lead cable with DN005 outdoor plug, 3A AC / DC, connectable. 230V, 27.6W.

**DS-LEDCPLR-2M-864**

2 x 4M, 12 strings, 4M / string, 72 LEDs / string, totaled 864 LEDs, with sealed cap. 1.5M 2 x 0.75sqm lead cable with DN005 outdoor plug, 3A AC / DC, connectable. 230V, 55.2W.

**DS-LEDIPLR Series LED Icicle Light**

Outdoor and indoor use. Packaged in colorful carton.

This icicle light may be used in the building wall, roof, window and other similar places' decoration.

**▼ Product Highlights**

- Multi - Fix compatible
- Brilliant shine LED light
- Replaceable segment
- Low heat emission
- Low power consumption
- Super long life - span
- **Protection Class:** IP44
- There are eight colors (Red, Yellow, Amber, Blue, Green, White, Warm white, Pink).

**▼ Models****DS-LEDIPLR-5730-114**

3 x 0.5M, totaled 114 LEDs, with sealed cap, 3 / 4 / 5 / 4 structure.

1.5M 2 x 0.75sqm lead cable with DN005 outdoor plug, 3A AC / DC, connectable. 230V, 9.2W.

**DS-LEDIPLR-3830-228**

3 x 1M, totaled 228 LEDs, with sealed cap, 6 / 8 / 10 / 8 structure.

1.5M 2 x 0.75sqm lead cable with DN005 outdoor plug, 3A AC / DC, connectable. 230V.

**DS-LEDIPLR-3840-304**

4 x 1M, totaled 304 LEDs, with sealed cap, 6 / 8 / 10 / 6 structure.

1.5M 2 x 0.75sqm lead cable with DN005 outdoor plug, 3A AC / DC, connectable. 230V.

**DS-LEDIPLR-38-150-304**

4 x 1.5M, totaled 304 LEDs, with sealed cap, 3 / 8 / 15 / 8 / 4 structure.

1.5M 2 x 0.75sqm lead cable with DN005 outdoor plug, 3A AC / DC, connectable. 230V.

**▼ Specifications**

Model	Inner Box	PCS / CTN	Export CTN	N.W.	G.W.	Unit Price
DS-LEDIPLR-5730-114	25 x 19 x 11cm	8	46 x 40 x 27cm	10.5kg	11.5kg	≤ \$20.50
DS-LEDIPLR-3830-228	34 x 20 x 10cm	10	52.5 x 42 x 36cm	15.2kg	16.4kg	≤ \$35.90
DS-LEDIPLR-3840-304	34 x 34 x 9cm	5	47.5 x 36 x 36cm	13.5kg	14.5kg	≤ \$46.92
DS-LEDIPLR-38-150-304	34 x 34 x 9cm	5	47.5 x 36 x 36cm	15.8kg	16.8kg	≤ \$46.92

This quotation is average price of different colors, and there are differences among the prices.

Please visit our website [www.Sign-in-China.com](http://www.Sign-in-China.com) to get details for reference.



## DS-LEDNLR Series LED Single Bulb Net Light and LED Twin Bulb Net Light

Outdoor and indoor use. Packed in colorful carton.

This light can be used in the building wall, trees, garden and other similar places' decoration.

### ▼ Product Highlights

- Multi - Fix compatible
- Brilliant shine LED light
- Low heat emission
- Low power consumption
- Super long life - span
- **Protection Class: IP44**
- There are eight colors (Red, Yellow, Amber, Blue, Green, White, Warm white, Pink).

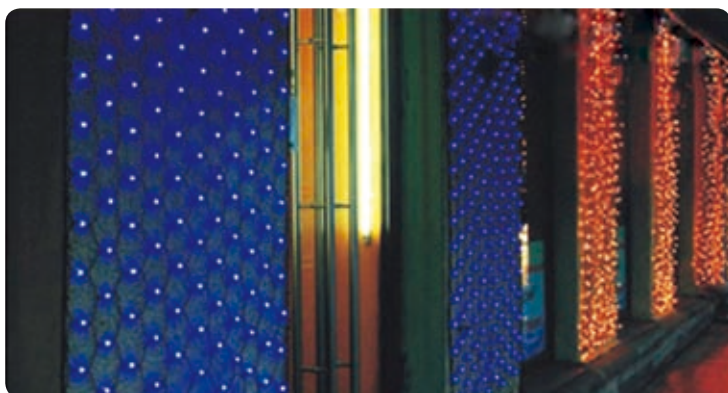

### ▼ Models

#### DS-LEDNLR-176: LED Single Bulb Net Light

2 x 0.8M, 176 LEDs, with sealed cap.

1.5M 2 x 0.75sqm lead cable with DN005 outdoor plug, connectable. 230V.

#### DS-LEDNLR-288: LED Single Bulb Net Light

2 x 1.2M, 288 LEDs, with sealed cap.

1.5M 2 x 0.75sqm lead cable with DN005 outdoor plug, connectable. 230V.

#### DS-LEDNLR-320: LED Single Bulb Net Light

1.2 x 2.2M, 320 LEDs, with sealed cap.

1.5M 2 x 0.75sqm lead cable with DN005 outdoor plug, connectable. 230V.

#### DS-LEDNLR-432: LED Single Bulb Net Light

3 x 1.5M, 432 LEDs, with sealed cap.

1.5M 2 x 0.75sqm lead cable with DN005 outdoor plug, connectable. 230V.

#### DS-LEDNLR-406: LED Twin Bulb Net Light

2.5 x 1.2M, 406 LEDs, with sealed cap.

1.5M 2 x 0.75sqm lead cable with DN005 outdoor plug, connectable. 230V.

#### DS-LEDNLR-648: LED Twin Bulb Net Light

4 x 2M, 648 LEDs, with sealed cap.

1.5M 2 x 0.75sqm lead cable with DN005 outdoor plug, connectable. 230V.



### ▼ Specifications

Model	Inner Box	PCS / CTN	Export CTN	N.W.	G.W.	Unit Price
DS-LEDNLR-176	30 x 20 x 10cm	6	42 x 32 x 32cm	11.5kg	12.5kg	≤ \$32.88
DS-LEDNLR-288	34 x 20 x 10cm	6	42 x 36 x 32cm	13kg	14kg	≤ \$52.10
DS-LEDNLR-320	34 x 20 x 10cm	10	52.5 x 42 x 36cm	22kg	23.2kg	≤ \$57.66
DS-LEDNLR-432	38 x 34 x 8cm	5	42.5 x 40 x 36cm	16.6kg	17.6kg	≤ \$76.46
DS-LEDNLR-406	34 x 26 x 10cm	8	54.5 x 42 x 36cm	23.8kg	25.1kg	≤ \$65.22
DS-LEDNLR-648	38 x 34 x 8cm	5	42.5 x 42 x 36cm	23kg	24kg	≤ \$113.42

This quotation is average price of different colors, and there are differences among the prices. Please visit our website [www.Sign-in-China.com](http://www.Sign-in-China.com) to get details for reference.

## DS-LEDMGLR Series LED Garland Light



Outdoor and indoor use. Packaged in colorful carton.

This light may be used in the building hall roof, street, garden and other similar places' decoration.

### ▼ Models

#### DS-LEDMGLR-1.4M-144

1.4M length, 144 LEDs, with sealed cap

1.5M 2 x 0.75sqm lead cable with DN005 outdoor plug, connectable. 230V, 11W

#### DS-LEDMGLR-2.7M-180

2.7M length, 180 LEDs, with sealed cap

1.5M 2 x 0.75sqm lead cable with DN005 outdoor plug, 3A AC / DC transfer, connectable. 230V

### ▼ Product Highlights

- Multi - Fix compatible
- Brilliant shine LED light
- Low heat emission
- Super long life time
- **Protection Class:** IP44
- There are eight colors (Red, Yellow, Amber, Blue, Green, White, Warm white, Pink).

### ▼ Specifications

Model	Inner Box	PCS / CTN	Export CTN	N.W.	G.W.	Unit Price
DS-LEDMGLR-1.4M-144	34 x 20 x 10cm	10	52.5 x 42 x 36cm	15kg	16.2kg	≤ \$24.85
DS-LEDMGLR-2.7M-180	30 x 28 x 12cm	6	58.5 x 38 x 32cm	12kg	13.2kg	≤ \$33.57

This quotation is average price of different colors, and there are differences among the prices. Please visit our website [www.Sign-in-China.com](http://www.Sign-in-China.com) to get details for reference.

## DS-LEDTWR Series LED Twinkle Light

Outdoor and indoor use. Packaged in colorful carton.

This light may be used in the building hall, garden, stage and other similar places' decoration.

### ▼ Product Highlights

- Brilliant shine LED light
- 8 Function Controllers
- Low heat emission
- Low power consumption
- Super long life - span
- Protection Class: IP44
- There are eight colors (Red, Yellow, Amber, Blue, Green, White, Warm white, Pink) and one kind of multi - color (R / Y / B / G).

### ▼ Models

#### DS-LEDTWR-6M-144

6M length, 144 LEDs, with sealed cap

1.5M 2 x 0.75sqm lead cable with DN005 outdoor plug, 5 wire uncontestable, 8 function IP44 controller. 230V, 12W

#### DS-LEDTWR-6M-144C

6M length, 144 LEDs, with sealed cap

1.5M 2 x 0.75sqm lead cable with DN005 outdoor plug, 3 wire connectable, 8 function IP44 controller. 230V, 12W

#### DS-LEDTWR-10M-180

10M length, 180 LEDs, with sealed cap

1.5M 2 x 0.75sqm lead cable with DN005 outdoor plug, 5 wire unconnectable, 8 function IP44 controller. 230V, 15W

#### DS-LEDTWR-10M-180C

10M length, 180 LEDs, with sealed cap

1.5M 2 x 0.75sqm lead cable with DN005 outdoor plug, 3 wire connectable, 8 function IP44 controller. 230V, 15W

### ▼ Specifications

Model	Inner Box	PCS / CTN	Export CTN	N.W.	G.W.	Unit Price
DS-LEDTWR-6M-144	28 x 20 x 8cm	10	42.5 x 42 x 30cm	13kg	14kg	≤ \$26.09
DS-LEDTWR-6M-144C	28 x 20 x 8cm	10	42.5 x 42 x 30cm	14kg	15kg	≤ \$27.10
DS-LEDTWR-10M-180	28 x 20 x 11cm	8	46.5 x 42 x 30cm	15kg	16kg	≤ \$33.25
DS-LEDTWR-10M-180C	28 x 20 x 11cm	8	46.5 x 42 x 30cm	15.8kg	16.8kg	≤ \$34.15



## &gt; Decorative Light &gt; Rope light string

**DS-LEDRL-230V Series LED2 Wire Standard Rope Light**

Outdoor and indoor use.

It's mainly used in building, venue, scenic spots, bridge, parks, etc.  
Available in length of 45m, 50m, 90m and 100m in plastic reel.

**Model:** DS-LEDRL-50M-36-230V,  
DS-LEDRL-36-100M-230V  
DS-LEDRL-45M-24-230V,  
DS-LEDRL-90M-24-230V

**▼ Product Highlights**

- Multi - Fix compatible
- Anti - UV, anti - static
- Super bright LED light
- Energy saving, low heat emission, long life - span
- Protection Class: IP44
- There are eight kinds of colors (Red, Yellow, Amber, Blue, Green, White, Warm white, Pink) and one kind of multi - color (R / Y / B / G).

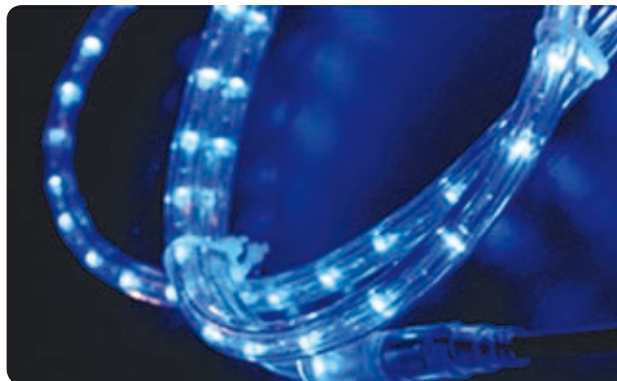
**▼ Models****DS-LEDRL-50M-36-230V**

**Dia.:** 13mm  
**Length:** 50m in plastic reel  
**Cut Unit:** 2m  
230V \ 115W \ 1800LEDs

**DS-LEDRL-45M-24-230V**

**Dia.:** 13mm  
**Length:** 45m in plastic reel  
**Cut Unit:** 3m  
230V \ 69W \ 1080LEDs

**DS-LEDRL-100M-36-230V**

**Dia.:** 13mm  
**Length:** 100m in plastic reel  
**Cut Unit:** 2m  
230V \ 230W \ 3600LEDs

**DS-LEDRL-90M-24-230V**

**Dia.:** 13mm  
**Length:** 90m in plastic reel.  
**Cut Unit:** 3m  
230V \ 138W \ 2160LEDs.

**▼ Power Kit****1.5m power cord with AC / DC adapter (DS-LEDPK-RL1.5M)**

IP44 plug  
1C connector  
Male pin  
Glue bottle  
End cap  
Blister package

**▼ Specifications**

Model	Inner Box	PCS / CTN	Export CTN	N.W.	G.W.	Price
DS-LEDRL-50M-36-230V	No	1	28 x 28 x 22cm	8.4kg	8.9kg	≤ \$130.66
DS-LEDRL-100M-36-230V	No	1	36 x 36 x 23cm	17.4kg	18.1kg	≤ \$260.26
DS-LEDRL-45M-24-230V	No	1	28 x 28 x 22cm	7.5kg	8kg	≤ \$92.28
DS-LEDRL-90M-24-230V	No	1	36 x 36 x 23cm	15.6kg	16.3kg	≤ \$183.56

This quotation is average price of different colors, and there are differences among the prices.  
Please visit our website [www.Sign-in-China.com](http://www.Sign-in-China.com) to get details for reference.

## &gt; Decorative Light &gt; Rope light string

**DS-LEDRL-230VCH Series LED 2 Wire Chasing Rope Light**

Outdoor and indoor use.

It's mainly used in building, venue, scenic spots, bridge, parks, etc.  
Available in length of 48m and 100m in plastic reel.

**Model:** DS-LEDRL-48M-36-230VCH,  
DS-LEDRL-100M-36-230VCH,  
DS-LEDRL-48M-24-230VCH,  
DS-LEDRL-100M-24-230VCH

**▼ Product Highlights**

- Multi - fix compatible
- Anti - UV, anti - static, super bright LED light
- Energy saving, low heat emission, long life - span
- Protection Class: IP44
- There are eight colors (Red, Yellow, Amber, Blue, Green, White, Warm white, Pink) and one multi-color (R / Y / B / G).

**▼ Models****DS-LEDRL-48M-36-230VCH**

**Dia.:** 13mm  
**Length:** 48m in plastic reel  
**Cut Unit:** 4m  
230V \ 55.2W \ 1728LED

**DS-LEDRL-100M-36-230VCH**

**Dia.:** 13mm  
**Length:** 100m in plastic reel  
**Cut Unit:** 4m  
230V \ 115W \ 3600LED

**DS-LEDRL-48M-24-230VCH**

**Dia.:** 13mm  
**Length:** 48m in plastic reel  
**Cut Unit:** 4m  
230V \ 55.2W \ 1152LED

**DS-LEDRL-100M-24-230VCH**

**Dia.:** 13mm  
**Length:** 100m in plastic reel  
**Cut Unit:** 4m  
230V \ 138W \ 3400LED

**▼ Power Kit is supplied separately**

RLC-2W20M-OUT  
RLC-2W50M-OUT  
RLC-2W100M-IND

**▼ Specifications**

Model	Inner Box	PCS / CTN	Export CTN	N.W.	G.W.	Price
DS-LEDRL-48M-36-230VCH	No	1	28 x 28 x 22cm	8.4kg	8.9kg	≤ \$126.67
DS-LEDRL-100M-36-230VCH	No	1	36 x 36 x 23cm	17.4kg	18.1kg	≤ \$262.63
DS-LEDRL-48M-24-230VCH	No	1	28 x 28 x 22cm	8.4kg	8.9kg	≤ \$101.17
DS-LEDRL-100M-24-230VCH	No	1	36 x 36 x 23cm	17.4kg	18.1kg	≤ \$209.48

This quotation is average price of different colors, and there are differences among the prices.  
Please visit our website [www.Sign-in-China.com](http://www.Sign-in-China.com) to get details for reference.



## &gt; Decorative Light &gt; LED strip

**LED Strip**

- Long service time: 50000 hours
- No flickering
- No RF interference
- High brightness

**SMD 5050 150LED / 5M / Reel DC12V****▼ Specifications****Input:** 12V DC**Light Source:** SMD5050 150pcs / 5m. 3 LEDs Cuttable**Power:** 22.5W**Beam Angle:** 120 degree**Dimension:** L5000 x W10mm**PCB Color:** Yellow / White

3M Double Side Tape, 15cm power cable at one end

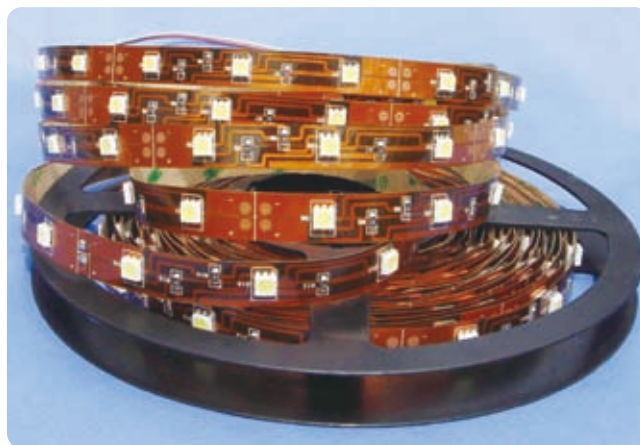
**Certification:** CE / ROHS**Packing:** 5m / reel / anti - static bag**Minimum Order:** 1 Reel**▼ Price List**

IP Grade	Color	Unit Price
Non - waterproof	Warm white / Pure white	≤ \$31.7 / reel
	Green / Blue / Yellow / Red	≤ \$32 / reel
IP65 Waterproof II	Warm white / Pure white	≤ \$36.7 / reel
	Green / Blue / Yellow / Red	≤ \$36.7 / reel
IP67 Waterproof III	Warm white / Pure white	≤ \$39 / reel
	Green / Blue / Yellow / Red	≤ \$39 / reel

**SMD 5050 300LEDs / 5M / Reel DC12V****▼ Specifications****Input:** 12V DC**Light Source:** SMD5050 300pcs / 5m. 3 LEDs Cuttable**Power:** 45W**Beam Angle:** 120 degree**Dimension:** L5000 x W10mm**PCB Color:** Yellow / White

3M double side tape, 15cm power cable at one end

**Certification:** CE / ROHS**Packing:** 5m / reel / anti - static bag**Minimum Order:** 1 Reel**▼ Price List**

IP Grade	Color	Unit Price
Non - waterproof	Warm white / Pure white	≤ \$52.9 / reel
	Green / Blue / Yellow / Red	≤ \$52.9 / reel
IP65 Waterproof II	Warm white / Pure white	≤ \$57.9 / reel
	Green / Blue / Yellow / Red	≤ \$57.9 / reel
IP67 Waterproof III	Warm white / Pure white	≤ \$62.8 / reel
	Green / Blue / Yellow / Red	≤ \$62.8 / reel

## &gt; Decorative Light &gt; LED strip

**SMD 3528 300LED / 5M / Reel DC12V**

## ▼ Specifications

**Input:** 12V DC**Light Source:** SMD3528 300pcs / 5m. 3 LEDs Cuttable**Power:** 18W**Beam Angle:** 120 degree**Dimension:** L5000 x W8mm**PCB Color:** Yellow / White

3M double side tape, 15cm power cable at one end

**Certification:** CE / ROHS**Packing:** 5m / reel / anti - static bag**Minimum Order:** 1 Reel

## ▼ Price List

IP Grade	Color	Unit Price
Non - waterproof	Warm white / Pure white	≤ \$19.83 / reel
	Green / Blue / Yellow / Red	≤ \$19.83 / reel
IP65 Waterproof II	Warm white / Pure white	≤ \$24.79 / reel
	Green / Blue / Yellow / Red	≤ \$24.79 / reel
IP67 Waterproof III	Warm white / Pure white	≤ \$29.75 / reel
	Green / Blue / Yellow / Red	≤ \$29.75 / reel

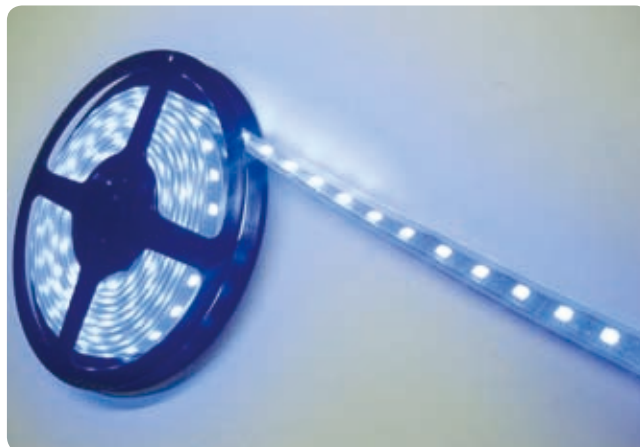
**SMD 3528 600LED / 5M / Reel DC12V**

## ▼ Specifications

**Input:** 12V DC**Light Source:** SMD3528 600pcs / 5m. 3 LEDs Cuttable**Power:** 36W**Beam Angle:** 120 degree**Dimension:** L5000 x W8mm**PCB Color:** Yellow / White3M double side tape,  
15cm power cable at one end**Certification:** CE/ROHS**Packing:** 5m / reel /

anti - static bag

**Minimum Order:** 1 Reel

## ▼ Price List

IP Grade	Color	Unit Price
Non - waterproof	Warm white / Pure white	≤ \$32.4 / reel
	Green / Blue / Yellow / Red	≤ \$32.4 / reel
IP65 Waterproof II	Warm white / Pure white	≤ \$37.36 / reel
	Green / Blue / Yellow / Red	≤ \$37.36 / reel
IP67 Waterproof III	Warm white / Pure white	≤ \$42.31 / reel
	Green / Blue / Yellow / Red	≤ \$42.31 / reel

# 05 PHOTO STUDIO



Price: ≤ \$863 / set  
on P340



Price: ≤ \$717 / set  
on P339



Price: ≤ \$143 / set  
on P348



Price: ≤ \$1,896 / set  
on P343



Price: ≤ \$14 / pc  
on P351



Price: ≤ \$200 / set  
on P346

## P338 | Book Binding Machine

P338 | Photo book station

P339 | Perfect binding machine

P341 | Book hard cover maker

P343 | Electric guillotine paper cutter

## P344 | Book Binding Auxiliary Device

P344 | Book pressing machine

P345 | Joint pressing machine

P346 | Paper creasing machine

## P348 | Photo & Card Cutter

P352 | Laminator

## P354 | Photo Studio Supplies

P354 | Photo paper

P355 | Photo laminating film

## SIC-HY-PBS Series All - in - one Photo Book Station with Foot Switch

- Suitable for making album, menu, double - page of hard cover binding and other kinds of individualized photo albums, etc.
- Compactly designed, all in one only solution with little dimensions, friendly to be used and maintained.
- Creasing, gluing, butterfly binding, nipping in one machine.
- Manual creasing machine, to crease photos in order to make the opening easier.
- Motorized gluing machine, to glue photos.
- Table for book - assembling, to couple photos and to form the album.
- Press for glue - drying.
- Fast and easy to operate.

### ▼ Specifications

Model	SIC-HY-PBS18	SIC-HY-PBS18Q
Operation Mode	Manual	Pneumatic
Creasing Width	460mm (18")	460mm (18")
Gluing Width	500mm (20")	500mm (20")
Maximum Size	500mm (20")	500mm (20")
Maximum Flatten Area	350mm x 470mm (14" x 18")	350mm x 470mm (14" x 18")
Maximum Flatten Height	80mm (3")	80mm (3")
Occupy Space	1000mm x 1100mm (1.1m <sup>2</sup> ) (39" x 43")	1000mm x 1100mm (1.1m <sup>2</sup> ) (39" x 43")
Machine Dimension (L x W x H)	800mm x 400mm x 1080mm (31" x 16" x 43") (Gluing machine)	800mm x 400mm x 1080mm (31" x 16" x 43") (Gluing machine)
	1040mm x 560mm x 1200mm (41" x 22" x 47") (Main engine)	1040mm x 560mm x 1200mm (41" x 22" x 47") (Main engine)
Power Supply	220V & 110V (Optional) 120W	220V & 110V (Optional) 120W
Machine Weight	88kg (Gluing machine) 133kg (Main engine)	88kg (Gluing machine) 133kg (Main engine)

**Price** ≤ \$3,110 ≤ \$3,746



## SIC-HY-PMS12A: Photobook Mini Station

- This machine features a photobook mounting part and hard cover casing - in part, you can produce any book format from 50 x 50mm up to 305 x 305 mm (A4) and 80mm (3.1") thick.
- Tabletop in size, easy to use and economical, anyone can create a beautiful, professional photobook in minutes.
- Suitable for photographic paper, card, laminated material or any print for your pictures.

- On - Demand Photobook maker.
- Albums open flat - 180 degrees.
- The unique damping mounting lift makes the mounting easily and fast.
- Adopts the special process against tacky in mounting unit.
- Presets many register slots, convenient to make different size of albums.
- Equipped with deep magnet moving petitioners, suitable for many sizes of mounting sheets.
- Cover mounting unit makes the block and cover attaching precisely and fast.
- Designed for portable plate board, convenient to remove it while mounting the thicken cover.

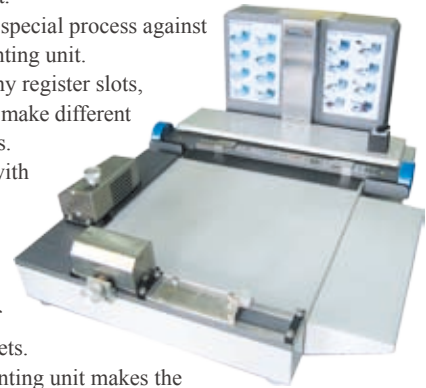

## SIC-HY-PMS Series Photobook Mini Station

- Fast, precise, convenient and high quality photobook manufacture system.
- Tabletop in size, easy to use and economical, anyone can create a beautiful, professional Photobook in minutes.
- Adopts the special process against tacky in mounting unit.
- The unique damping mounting lift makes the mounting easily and fast.
- Equipped with cover localization guide rail and cover casing - in locator.
- Cover localization guide rail makes the block and cover attaching precisely and fast.
- Albums open flat - 180 degrees.
- Can produce any book format from 2" x 2" up to 12" x 12" (PMS18: up to 18" x 18") and 80mm thick.
- Suitable for photographic paper, card, laminated material or any print for your pictures.



### ▼ Specifications

Model	SIC-HY-PMS12	SIC-HY-PMS18
Maximum Print Size	321mm x 630mm (13" x 25")	457mm x 914mm (18" x 36")
Maximum Album Size	310mm x 316mm (12" x 12")	457mm x 457mm (18" x 18")
Minimum Album Size	50mm x 50mm (2" x 2")	50mm x 50mm (2" x 2")
Maximum Binding Thickness	80mm (3")	80mm (3")
Machine Dimension (L x W x H)	620mm x 510mm x 320mm (24" x 20" x 13")	760mm x 665mm x 330mm (30" x 26" x 13")
Machine Weight	19kg	25kg

**Price** ≤ \$784 ≤ \$898

### ▼ Specifications

Model	SIC-HY-PMS12A
Maximum Print Size	321mm x 630mm (13" x 25")
Maximum Album Size	310mm x 316mm (12" x 12")
Minimum Album Size	50mm x 50mm (2" x 2")
Maximum Binding Thickness	80mm (3")
Machine Dimension (L x W x H)	670mm x 520mm x 310mm (26" x 20" x 12")
Machine Weight	26kg

**Price** ≤ \$898

> Book Binding Machine > Perfect binding machine

### SIC-HY-NCB55A: 435mm x 550mm (17" x 22") Automatic Perfect Binding Machine

▼ Main functions of the numerical control text display screen

- **Set up system parameter:** Book position, temperature of melting glue, temperature of keeping, spine nipping time and pressure, etc. Choose working mode (binding / hanging), and running mode (Manual / auto).
- **Set up craft parameter:** According to the real working condition, regulate thickness of the cover, working temperature, the amount of glue and book smoothness at any time to reach the best binding result.
- **Working state mode:** Showing the operation process real - timely and dynamically, from starting the machine to the binding, the steps all may be showed, and the operator can control the machine at any time. With binding quantity and job time showing, convenient to count work load and operating cost.
- **Warning mode:** Can auto - alarm when the machine breaks down in running, and show the trouble spot.
- The free rotary numerical control text display screen can be regulated the position according to the need. It is convenient to help operator adjust the operational parameter, observe the working state of the equipment in real time.



▼ Specifications

Model	SIC-HY-NCB55A
Maximum of Book Size	435mm x 550mm (17" x 22")
Minimum of Book Size	80mm x 60mm (3" x 2")
Book Thickness	2 sheets - 55mm (2.2")
Binding In-Page	Single Sheet - 2 fold out
Milling Cutter Mode	12 - gear disk milling cutter and small milling cutter
Time of Gluing	About 30min
Mechanical Speed	Up to 300 cycles / hr
Power Supply	220V
Machine Dimension (L x W x H)	1380mm x 680mm x 1200mm (54" x 27" x 47")
Machine Weight	205kg
<b>Price</b>	<b>≤ \$8,065</b>

### SIC-HY-S320: 320mm (13") Perfect Binding Machine

- The compact S320 offers the advantages of perfect binding, combined in one economical, easy to operate.
  - It is the ideal machine for making books with either soft or hard covers, in the office, copy shop or small print room.
  - The binding speed is determined by the operator and binding thickness.
  - Standard type is right hand lever.
- And you can choose left hand lever. You can also choose to equip it with book desk for cold glue binding.



▼ Specifications

Model	SIC-HY-S320
Min-Max Binding Thickness	0.1 - 40mm (0.003" - 1.5")
Maximum Width of The Sheet	320mm x 235mm (13" x 9")
Maximum Cover Thickness	400g / m <sup>2</sup>
Time of Gluing	Ten minutes with temperature indicating lamp
Capacity Books/Hour	Up to 120
Power Supply	220V or 110V (Optional)
Machine Dimension (L x W x H)	670mm x 360mm x 500mm (26" x 14" x 20")
Machine Weight	32kg
<b>Price</b>	<b>≤ \$645</b>

### SIC-HY-S320D: 320mm x 235mm (13" x 9") Perfect Binding Machine

▼ Dust - free spine roughening unit

- Paper binding and Jewelled binding in one machine.
- Unlike other spine rougher that grinds the spine creating lots of noise and dust. Using this dust - free spine roughening unit, it opens the paper grain with very little noise and no paper dust. It makes the machine suitable for handling the most difficult papers and making the solid bound.



▼ Dust - free spine roughening unit feathers

- Two groups of roughening tooth with special angle and interval.
- Convenient to adjust the depth and angle of roughening.
- Grind the spine to strengthen the permeability of glue.
- Compress the spine into a shape of fan to increase the sticking surface.

▼ Specifications

Model	SIC-HY-S320D
Binding Thickness	0.1 - 40mm (0.003" - 1.5")
Maximum Width of The Sheet	320mm x 235mm (13" x 9")
Maximum Cover Thickness	400g / m <sup>2</sup>
Time of Gluing	Ten minutes with temperature indicating lamp
Capacity Books / Hour	Up to 120
Power Supply	220V or 110V (Optional)
Machine Dimensions (L x W x H)	790mm x 360mm x 500mm (31" x 14" x 20")
Machine Weight	33kg
<b>Price</b>	<b>≤ \$717</b>

## > Book Binding Machine > Perfect binding machine

### SIC-HY-S460E: 460mm x 325mm (18" x 13") Perfect Binding Machine

- It quickly produces hard and soft cover books as well as manager covers, tear - off pads and strip binding. The perfect binding is strong, square and affordable.
- The binding speed is determined by the operator and binding thickness.
- Standard type is right hand lever, but you can choose left hand lever. You can also choose to equip it with book desk for cold glue binding.



#### ▼ Specifications

Model	SIC-HY-S460
Binding Thickness	0.1 - 40mm (0.003" - 1.5")
Maximum Width of The Sheet	460mm x 325mm (18" x 13")
Maximum Cover Thickness	400g / m <sup>2</sup>
Time of Gluing	Ten minutes with temperature indicating lamp
Capacity Books / Hour	Up to 120
Power Supply	220V or 110V (Optional)
Machine Dimension (L x W x H)	800mm x 395mm x 570mm (31" x 16" x 22")
Machine Weight	35kg
<b>Price</b>	<b>≤ \$739</b>

### SIC-HY-S460D: 460mm x 325mm (18" x 13") Perfect Binding Machine (Dust - free Spine Roughening Unit)

Unlike other spine rougher that grinds the spine creating lots of noise and dust. Using this dust - free spine roughening unit, it opens the paper grain with very little noise and no paper dust. It makes the machine suitable for handling the most difficult papers and making the solid bound.

#### ▼ Dust - free spine roughening unit features

- Two groups of roughening tooth with special angle and interval.
- Convenient to adjust the depth and angle of roughening.
- Grind the spine to strengthen the permeability of glue.
- Compress the spine into a shape of fan to increase the sticking surface.

#### ▼ Specifications

Model	SIC-HY-S460D
Binding Thickness	0.1 - 40mm (0.003" - 1.5")
Maximum Width of The Sheet	460mm x 325mm (18" x 13")
Maximum Cover Thickness	400g / m <sup>2</sup>
Time Of Gluing	Ten minutes with temperature indicating lamp
Capacity Books / Hour	Up to 120
Power Supply	220V or 110V (Optional)
Machine Dimension (L x W x H)	930mm x 395mm x 580mm (37" x 16" x 23")
Machine Weight	42kg
<b>Price</b>	<b>≤ \$863</b>



## > Book Binding Machine > Book hard cover maker

### SIC-HY-SK530: 530mm x 370mm (21" x 15") Hard Cover Maker

- This machine is designed for compact table - top unit, position the cover sheet with side guide, the sizes of finished hard cover can reach A4 format.
- Work table of subdued light transmitting type.
- Side positioning, standard position - setting between the paper board and cover.
- Standard, normative, precise and high - speed manufacture of hardcover book case can be achieved by combinative use of our hardcover size online calculating serial products.

#### ▼ Specifications

Model	SIC-HY-SK530
The Size of Operation Desk	530mm x 370mm (21" x 15")
Maximum Size of Product	A4+ landscape size
Power Supply	220V / 110V (Optional)
Machine Dimensions (L x W x H)	760mm x 450mm x 250mm (30" x 18" x 10")
Machine Weight	19kg
The Thickness of Board	0.5mm - 6mm (0.02" - 0.23")
<b>Price</b>	<b>≤ \$300</b>



### SIC-HY-SK530A: 530mm x 370mm (21" x 15") Hard Cover Maker

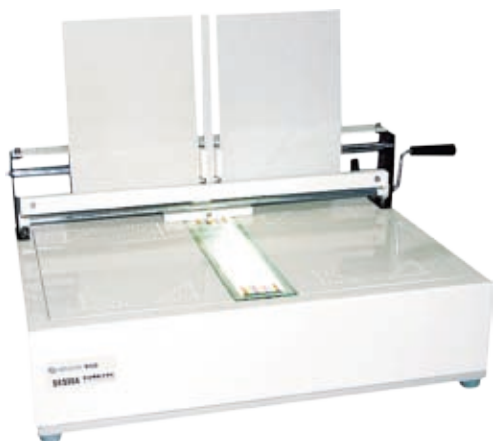

#### Negative Pressure - and - Adsorption Working Table & Centralized Positioning

- Suitable for the making of the book case of the hardcover, photo album and picture album.
- The light table includes suction assistance for placing the tacking papers, as well as a center scaled line and a top line for the most accurate settings.

#### ▼ Specifications

Model	SIC-HY-SK530A
The Size of Operation Desk	530mm x 370mm (21" x 15")
Maximum Size of Product	A4 + landscape size
Power Supply	220V / 110V (Optional)
Machine Dimensions (L x W x H)	780mm x 450mm x 250mm (31" x 18" x 10")
Machine Weight	20kg
The Thickness of Board	0.5mm - 6mm (0.02" - 0.23")
<b>Price</b>	<b>≤ \$448</b>

### SIC-HY-SK530B: 530mm x 420mm (21" x 16") Hard Cover Maker

#### Adsorption Working Table & Centralized Positioning & Corner Cutting & Electric Edge Folding

- Applicable for manufacturing hardcover book cases of hardcovers, albums, photograph album, picture album, etc.
- Positioning, corner cutter, electric edge folder in one machine.

#### ▼ Specifications

Model	SIC-HY-SK530B
The Size of Operation Desk	530mm x 420mm (21" x 16")
Maximum Size of Product	A4 + landscape size
Power Supply	220V / 110V (Optional)
Machine Dimensions (L x W x H)	850mm x 540mm x 340mm (33" x 21" x 13")
Machine Weight	45kg
The Thickness of Board	0.5mm - 6mm (0.02" - 0.23")
<b>Price</b>	<b>≤ \$1,546</b>



**SIC-JY-SK950C: 980mm x 466mm (38" x 18") Hard Cover Maker****Literature Table & Adsorption Working Table & Centralized Positioning & Corner Cutting & Electric Edge Folding**

- Applicable for manufacturing hardcover book cases of hardcovers, albums, photograph album, picture album, etc.
- Positioning, corner cutter, electric edge folder in one machine.
- Flexible and fast to change the different version of spine guides, easy to create many fully decorated hard cases as hard cover books, CD and DVD boxes, photo albums, restaurant menus, etc.
- Light table with center positioning line labels the reference meshed line for variety of formats with suction assistance for placing the tacking paper, you can position the cover accurately and quickly.
- A corner cutter allows you to cut the four corners of different thickness of cardboard in an even and accurate way.
- A user - friendly electric edge folder also makes the hard cover even more standardized.
- The original design allow not only to create book covers, but also any other fully decorated hard cases: CD and DVD boxes, restaurant menus and so on. You just need to change the two spine guides from a 8mm (0.31") - groove to a 3mm one.

**▼ Specifications**

Model	SIC-JY-SK950C
The Size of Operation Desk	980mm x 466mm (38" x 18")
Maximum Size of Product	A3 + landscape size
Power Supply	220V / 110V (Optional)
Machine Dimensions (L x W x H)	1140mm x 680mm x 1040mm (45" x 27" x 41")
Machine Weight	112kg
Standard Accessory	8mm (0.3") paper guide - Long
<b>Price</b>	<b>≤ \$2,386</b>

**SIC-HY-SKJ950B: 980mm x 466mm (38" x 18") Hard Cover Maker****Adsorption Working Table & Centralized Positioning & Corner Cutting & Electric Edge Folding**

- Applicable for manufacturing hardcover book cases of hardcovers, albums, photograph album, picture album, etc.
- Positioning, corner cutter, electric edge folder in one machine.
- SKJ950B is designed for table - top unit without the base cabinet. All the other features are the same as SKJ950B style.

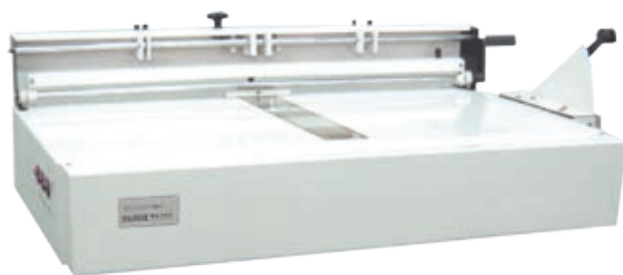
**▼ Specifications**

Model	SIC-HY-SKJ950B
The Size of Operation Desk	980mm x 466mm (38" x 18")
Maximum Size of Product	A3 + landscape size
Power Supply	220V / 110V (Optional)
Machine Dimensions (L x W x H)	1100mm x 670mm x 380mm (43" x 26" x 15")
Machine Weight	82kg
The Thickness of Board	0.5mm - 6mm (0.02" - 0.23")
<b>Price</b>	<b>≤ \$1,971</b>

**SIC-HY-SK950B: 980mm x 466mm (38" x 18") Hard Cover Maker**

- Applicable for manufacturing hardcover book cases of hardcovers, albums, photograph album, picture album, etc.
- Positioning, corner cutter, electric edge folder in one machine.
- With suction assistance for placing the tacking paper, you can position the cover accurately and quickly.
- A corner cutter allows you to cut the four corners with different thickness of cardboard in an even and accurate way.
- A user - friendly electric edge folder also makes the hard cover even more standardized.

**▼ Specifications**

Model	SIC-HY-SK950B
The Size of Operation Desk	980mm x 466mm (38" x 18")
Maximum Size of Product	A3 + landscape size
Power Supply	220V / 110V (Optional)
Machine Dimensions (L x W x H)	1180mm x 670mm x 1070mm (46" x 26" x 42")
Machine Weight	109kg
The Thickness of Board	0.5mm - 6mm (0.02" - 0.23")
<b>Price</b>	<b>≤ \$2,195</b>



### SIC-HY-430M: 430mm (17") Manual Paper Guillotine



- Specially designed for use in office, large administrative, copy centers, copy shops, in-house printing offices and small print shops.
- Manual fast flick action clamp. Spindle guided back gauge.
- Side lay with measuring scale. Blade from high quality steel.
- Fine adjustment of measurement with calibrated scale on the back gauge handle.
- Blade lock and safety guard on front table.
- Adjustable blade depth. Easy and simple blade change.
- Blade changing device with covered cutting edge.
- 430mm (17") cutting length for paper sizes up to A3.

#### ▼ Specifications

Model	SIC-HY-430M
Maximum Cutting Length	430mm (17")
Maximum Cutting Height	40mm (1.5")
Insertion Depth	430mm (17")
Machine Weight	53kg
Machine Dimension (L x W x H)	730mm x 610mm x 1020mm (29" x 24" x 40")
<b>Price</b>	<b>≤ \$735</b>

### SIC-HY-480M: 480mm (19") Manual Guillotine

- Powerful guillotine for manual operation with 475mm (19") cutting length and a cutting height of 80mm (3").
- A precise measuring scale is on the front machine table, the spindle guided backgauge with hand crank allows a precise adjustment of the desired measures.
- Specially designed for use in office, large administrative, copy centers, copy shops, in-house printing offices and small print shops.
- 480mm cutting length for paper sizes up to A3. Manual spiral action clamp. Spindle guided back gauge.
- Side lay with measuring scale.
- Fine adjustment of measurement with calibrated scale on the back gauge handle.
- Easy and simple for blade change.
- Adjustable blade depth.
- Blade lock and safety guard on front table.
- Blade from high quality steel.
- Blade changing device with covered cutting edge.

#### ▼ Specifications

Model	SIC-HY-480M
Maximum Cutting Length	475mm (19")
Maximum Cutting Height	80mm (3")
Insertion Depth	455mm (18")
Machine Weight	83kg
Machine Dimension (L x W x H)	780mm x 750mm x 1200mm (31" x 30" x 47")
<b>Price</b>	<b>≤ \$1,443</b>



### SIC-HY Series Electric Paper Guillotine

- Specially designed for use in office, large administrative, copy centers, copy shops, in-house printing offices and small print shops.

#### ▼ Specifications

Model	SIC-HY-4310	SIC-HY-4810
Maximum Cutting Length	430mm (17")	475mm (19")
Maximum Cutting Height	40mm (1.5")	80mm (3")
Insertion Depth	430mm (17")	455mm (18")
Machine Weight	102kg	173kg
Machine Dimension (L x W x H)	660mm x 750mm x 1150mm (26" x 29" x 45")	760mm x 850mm x 1250mm (30" x 33" x 49")
<b>Price</b>	<b>≤ \$1,896</b>	<b>≤ \$3,591</b>

**SIC-HY-HBP460: 460mm (18") Desktop Manual Pressing Machine**

- It is made of stainless steel, height and pressure can be adjusted by hand wheel.
- Most pressure can reach up to two ton.
- Manual, simple and high cost performance.

**▼ Specifications**

Model	SIC-HY-HBP460
Flatten Area	460mm x 350mm (18" x 14")
Flatten Height	70mm (3")
Machine Weight	52kg
Machine Dimension	530mm x 350mm x 300mm (21" x 14" x 12")
<b>Price</b>	<b>≤ \$443</b>

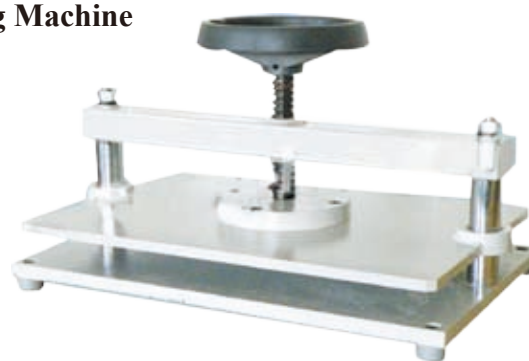
**SIC-HY-HBP500: 500mm (19") Manual Pressing Machine**

- It is made of stainless steel, height and pressure can be adjusted by hand wheel.
- Most pressure can reach up to two ton.
- Manual & simple.

**▼ Specifications**

Model	SIC-HY-HBP500
Flatten Area	500mm x 450mm (19" x 18")
Flatten Height	500mm (19")
Machine Weight	110kg
Machine Dimension	610mm x 450mm x 950mm (24" x 18" x 37")
<b>Price</b>	<b>≤ \$784</b>

**SIC-HY-EP460: 440mm (17") Desktop Electric Pressing Machine**

- Designed for Table top and electronic, easy to handle.
- Adopts frequency conversion and stainless steel brake motor, which ensures the optimal flattening effect of album and avoids uncontrollable flattening effect of ordinary pressing machines resulting from their squeezing pressure generally unable to change gradually.

**▼ Specifications**

Model	SIC-HY-EP460
Flatten Area	440mm x 300mm (17" x 12")
Flatten Height	70mm (3")
Machine Weight	95kg
Machine Dimension	530mm x 340mm x 490mm (21" x 13" x 19")
Power Supply	220V / 110V (Optional)
<b>Price</b>	<b>≤ \$1,125</b>

**SIC-HY-EP530: 530mm (21") Electric Pressing Machine**

- Used for pressing the album, photo book and menu.
- A brake motor of frequency conversion is adopted, which makes the pressure adaptable. This may ensure the optimal flattening effect of album and avoid uncontrollable flattening effect of ordinary pressing machines resulting from their squeezing pressure generally unable to change gradually.

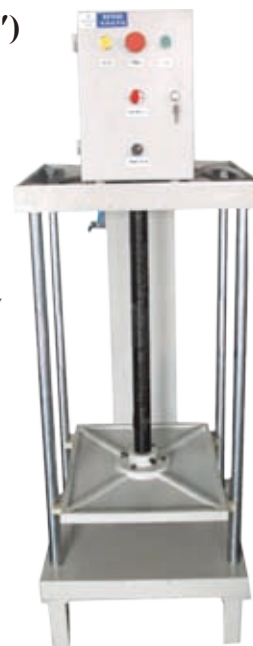
**▼ Specifications**

Model	SIC-HY-EP530
Flatten Area	530mm x 410mm (21" x 16")
Flatten Height	800mm (31")
Machine Weight	220kg
Machine Dimension	530mm x 530mm x 1600mm (21" x 21" x 63")
Power Supply	220V / 110V (Optional)
<b>Price</b>	<b>≤ \$1,852</b>



### SIC-HY-JY520: 520mm (20'') Vertical Joint Pressing

- It is suitable for molding the French joint on the hard cover books.
- The temperature is controlled by eight - figure microcomputer chips, it is displayed by digital adjusting device with three - figure.
- The gas feed structure facilitates the operation, which makes the machine work more steadily and the pressure better proportioned.
- The temperature, pressure, and position of the groove can be set and adjusted. The groove can be positioned by light.

#### ▼ Specifications

Model	SIC-HY-JY520
Maximum Pressing Width	520mm (20'')
The Power of Heat-Up	2 x 250W
Power Supply	220V / 110V (Optional)
Machine Weight	52kg
Machine Dimension	630mm x 450mm x 1150mm(25" x 18" x 45")
<b>Price</b>	<b>≤ \$920</b>

### SIC-HY-QJY520: 520mm (20'') Vertical Pneumatic Joint Pressing Machine



- It is suitable for molding the French joint on the hard cover books.
- Based on SIC-HY-JY520, it is equipped the air system and with by foot in pneumatic way, which is convenient to adjust the pressure through the button on the machine panel.
- The running of the machine is controlled by the electromagnetism valve.
- The temperature, pressure, and position of the groove can be set and adjusted. The groove can be positioned by light.

#### ▼ Specifications

Model	SIC-HY-QJY520
Maximum Pressing Width	520mm (20'')
The Power of Heat-Up	2 x 250W
Power Supply	220V / 110V (Optional)
Machine Weight	65kg
Machine Dimension	630mm x 450mm x 1150mm (25" x 18" x 45")
<b>Price</b>	<b>≤ \$1,005</b>



### SIC-HY-JY520E: 520mm (20'') Table-top Electric Joint Pressing Machine



- It is suitable for molding the French joint on the hard cover books.
- On the basis of SIC-HY-JY520, it is upgraded from foot operated to electrical and designed for table - top unit.
- Adopt electro type control system which is more accurate and convenient to adjust the pressure.
- The temperature, pressure, and position of the groove can be set and adjusted. The groove can be positioned by light.

#### ▼ Specifications

Model	SIC-HY-JY520E
Maximum Pressing Width	520mm (20'')
The Power of Heat-Up	2 x 250W
Power Supply	220V / 110V (Optional)
Machine Weight	55kg
Machine Dimension	630mm x 450mm x 580mm (25" x 18" x 23")
<b>Price</b>	<b>≤ \$920</b>

## SIC-HY-CCPE Series Multi - purpose Creasing Machine

- Single Creasing, spine and hinge creasing, perforating and slitting available in one machine.
- It is convenient and fast to assemble, disassemble or locate the modules. The motor can be operated by pedal or automatic mode switch.
- Electric powered. Creasing, perforating and slitting covers up to 650mm (25") in width.
- It is equipped with safety cover with an open - stop relay, safe and reliable.
- Many modules can be assembled for different needs of paper finishing.
- Produce 6 creases (Spine, hinge and overhang cover edges) at the same time.
- Designed for adjusting pressure outside, convenient to adjust the pressure of two ends.

### ▼ Specifications

Model	SIC-HY-CCP600E	SIC-HY-CCP650E
Infeed Width	630mm (25")	650mm (25")
Paper Weight	up to 400g / sq. m	80 - 400g / sqm
Creasing Mode	Electric	Electric
Power Supply	220V or 110V (Optional)	220V or 110V (Optional)
Machine Dimension	740mm x 460mm x 175mm (29" x 18" x 7")	740mm x 460mm x 175mm (29" x 18" x 7")
Machine Weight	35kg	35kg
<b>Price</b>	≤ \$893	≤ \$958

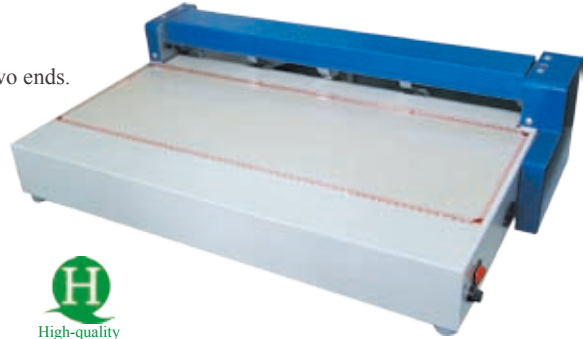

Normally, it comes with 2 modules of paper guide wheel and an individual single creasing module.

Choose the module as needed: Single line creasing module, Spine and hinge creasing module, slitting module and blade, perforating module and blade, paper guide wheel.

## SIC-HY-EC520: 520mm (20") Electric Creasing Machine

- It has extremely good effect upon dealing with the heat - laminated paper, and also can avoid the phenomenon of striping and edge bursting to the greatest extent.
- It provides 2 creasing widths as standard, with the ability to change from one to another in seconds.
- Designed for heating type, heating temperature is limitless adjustable within 99°C.



SIC-HY-EC520R is equipped with foot switch; it has the function of SIC-HY-EC520. Extremely good effect upon dealing with the heat - laminated paper, and also can avoid the phenomenon of striping and edge bursting to the greatest extent.

### ▼ Specifications

Model	SIC-HY-EC520	SIC-HY-EC520R
Maximum Creasing Width	520mm (20")	520mm (20")
Length of Orientation	530mm (21")	530mm (21")
Maximum Orientation Lines	2 lines	2 lines
Power Supply	220V or 110V (Optional)	220V or 110V (Optional)
Machine Dimension	800mm x 630mm x 230mm (31" x 25" x 9")	800mm x 630mm x 230mm (31" x 25" x 9")
Machine Weight	35kg	35kg
<b>Price</b>	≤ \$963	≤ \$1,075

## SIC-HY-DC Series Manual Creasing Machine

- Aluminum speed stops, DC series creasing machine are more convenient and flexible to locate the paper sheet.
- Ease to complete the single crease, double creases and Z folding.

### ▼ Specifications

Model	SIC-HY-DC355	SIC-HY-DC460
Creasing Width	355mm (14")	460mm (18")
Length of Orientation	320mm (12")	330mm (13")
Positioning Mode	Slide backstops	Slide backstops
Maximum Orientation Lines	2 lines	2 lines
Machine Dimension	600mm x 380mm x 170mm (24" x 15" x 7")	600mm x 500mm x 180mm (24" x 20" x 7")
Machine Weight	10kg	13kg
<b>Price</b>	≤ \$150	≤ \$200



## SIC-HY-HCP315: 315mm (12") Creasing & Perforating Machine

Perforates up to 250gsm paper. Perforates for food coupons, vouchers, etc.

- A millimeter scale is running along the sides of its base. It is used to adjust the front, rear, and angular stop. In the process of creasing, the paper weight can up to 400gsm. The width of crease is 1.2mm / 1.8mm. The weight of the machine is only 11.5kg. It is convenience for transformation.
- It offers great quality creasing and perforating of single sheets, for smooth folds and clean tear off.
- 0 - 90 degree creasing & perforating angle. Simple manual adjustment required to change codes.
- The mechanism is working with a knife and a v - shaped counter knife in order to be very smooth.

### ▼ Specifications

Model	SIC-HY-HCP315
Maximum Creasing Width	315mm (12")
Maximum Paper Thickness (Crease)	400g / sqm
Maximum Paper Thickness (Perforate)	250g / sqm
Creasing & Perforating Angle	0 - 90 degree
Machine Dimension	500mm x 380mm x 95mm (20" x 15" x 4")
Machine Weight	11.5kg
<b>Price</b>	<b>≤ \$375</b>



## SIC-HY-CDP500: Printing Finish & Photography Equipment

Convenient to cut full page visit cards or irregular cards, it also can be used for making gift box, wine box, postcard, CD box, JIGSAW puzzle or any different individualized products.

- It features with die cutting and pressing. High - accuracy steel rod. Shows and regulates accurately with pressure indicator of both ends.
- Pedal control



### ▼ Specifications

Model	SIC-HY-CDP500
Maximum Working Width	500mm (20")
Minimum Distance Between Cylinders	26mm (1")
Maximum Distance Between Cylinders	30mm (1.2")
Paper Weight	Maximum 1000g / sq. m
Power Supply	220V / 110V (Optional)
Machine Weight	62kg
Machine Dimension	770mm x 735mm x 400mm (30" x 29" x 16")
<b>Price</b>	<b>≤ \$1,523</b>

## SIC-HY-CPC480: 480mm (19") Multi - purpose Creasing Machine

- Single creasing, spine and hinge creasing, perforating and slitting available in one machine.
- The motor can be operated by pedal or automatic mode switch. High - efficiently and speed - variable electromotor, LCD for machine operating speed, stepless regulation of speed.
- Equipped with individual modules, it is convenient and fast to assemble, disassemble or locate them, and also can combine them freely to crease, crease the spine and hinge, perforate and trim according to the requirements.
- Designed for adjusting pressure outside, convenient to adjust the pressure of two ends.
- With an individual rush stop switch, it is more safe and reliable to avoid the appearance of any hidden danger.
- Adjustable feeder and fine adjusting knob outside. Easy to position centering or leaning.
- The hanging type of delivery section is designed for magnetism sucking positioning by the sides and knob fastening by the back end.
- Normally equipped with paper downholders, or with metal block optional.
- Adopts the stainless steel material; it is perfect, wear - resisting and beautiful.

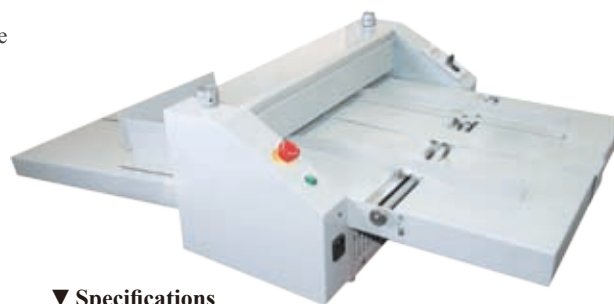

### ▼ Specifications

Model	SIC-HY-CPC480
Maximum Width of the Sheet	480mm (19")
Rotate Speed	90 ~ 1400 / min
Shaft Diameter	36mm (1.4")
Power Supply	220V or 110V (Optional)
Machine Dimension	1150mm x 620mm x 300mm (45" x 24" x 12")
Machine Weight	41kg
<b>Price</b>	<b>≤ \$2,400</b>

## &gt; Photo &amp; Card Cutter

**CS-SSB Series Semi - automatic Name Card Cutter**

This semi - automatic cutter is used for cutting business card. It's durable for the steel blade and the blade could be milled by itself to ensure it sharp.

- Durable blade, it's made of steel blade
- Time is saving and labor saving
- Semi-automatic, it's convenient to use
- High Precision, reasonable structure to ensure the card is cut accurately

**▼ Specifications**

Model	CS-SSB-001	CS-SSB-002	CS-SSB-003	CS-SSB-004
Paper Size	A4 (210mm x 297mm) (8" x 12")	A4 (210mm x 297mm) (8" x 12")	A4 (210mm x 297mm) (8" x 12")	A4 (210mm x 297mm) (8" x 12")
Size of Name Card	90mm x 54mm (3.5" x 2.1")	90mm x 50mm (3.5" x 1.9")	85mm x 55mm (3.3" x 2.2")	89mm x 54mm (3.5" x 2.1")
Life-span for Blade	≥ 100,000 times	≥ 100,000 times	≥ 100,000 times	≥ 100,000 times
Cutting Speed	30pcs / min	30pcs / min	30pcs / min	30pcs / min
G.W.	18.8kg	18.8kg	18.8kg	18.8kg
<b>Price</b>	≤ \$143 / set	≤ \$143 / set	≤ \$143 / set	≤ \$143 / set

**CS-SSA-001: A4 Size Multi - function Full - auto Card Cutter**

This full - automatic cutter is used for cutting business card, photos and various of certificate cards, etc.

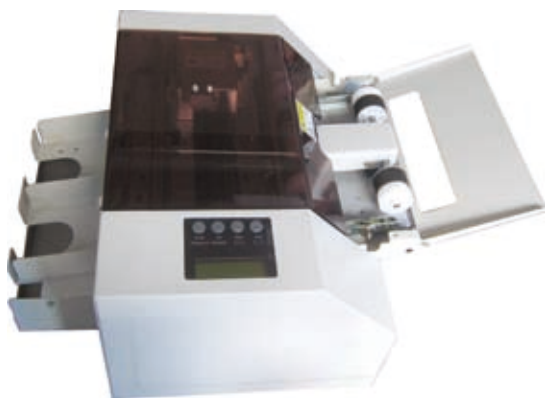

- Durable blade, it's made of steel blade
- Time saving and labor saving
- Multi - function full-automatic, it's convenient to use
- High Precision, reasonable structure to ensure the card is cut accurately
- Electronic eye induction system and microcomputer control
- Unique unitary design of longitudinal cutter case, fast to replace

**▼ Specifications**

Model	CS-SSA-001
Paper Size	A4 (210mm x 297mm) (8" x 12")
Size of Name Card	(85mm / 89mm / 90mm) x (40mm - 150mm) (3.3" / 3.5" / 3.6") x (1.6" - 5.9")
Thickness of Paper	0.2mm (0.008") (180g / m <sup>2</sup> ) - 0.35mm (0.013") (350g / m <sup>2</sup> )
Loading of Paper	12pcs
Life-span for Blade	≥ 100,000 times
Cutting Speed	30pcs / min
Dimensions	430mm x 385mm x 220mm (16.9" x 15.2" x 8.6")
G.W.	25kg
<b>Price</b>	≤ \$1,211 / set

## &gt; Photo &amp; Card Cutter

**CS-SSA-002: A3 Size Multi - function Full - auto Card Cutter**

This full - automatic cutter is used for cutting business card, photos and various of certificate cards, etc.

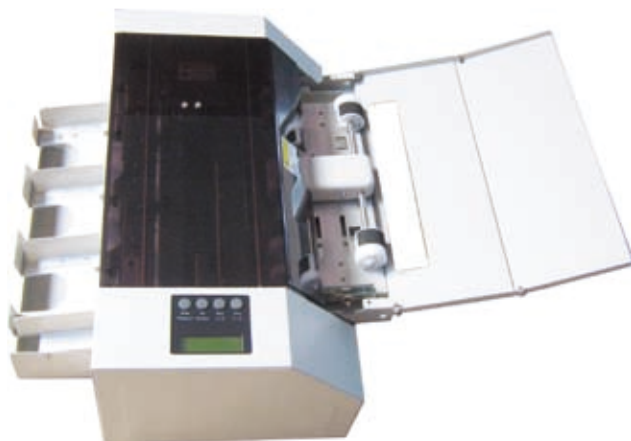

- Durable blade, it's made of steel blade
- Time saving and labor saving
- Multi - function full - automatic, it's convenient to use
- High Precision, reasonable structure to ensure the card is cut accurately
- Electronic eye induction system and microcomputer control
- Unique unitary design of longitudinal cutter case, fast to replace

**▼ Specifications**

Model	CS-SSA-002
Paper Size	A3 (297mm x 420mm) (12" x 16.5")
Size of Name Card	(85mm / 89mm / 90mm) x (40mm - 150mm) (3.3" / 3.5" / 3.6") x (1.6" - 5.9")
Thickness of Paper	0.2mm (0.008") (180g / m <sup>2</sup> ) - 0.35mm (0.013") (350g / m <sup>2</sup> )
Loading of Paper	12pcs
Life-span for Blade	≥ 100,000 times
Cutting Speed	67pcs / min for card
Dimensions	570mm x 490mm x 220mm (22.4" x 19.3" x 8.7")
G.W.	31kg
<b>Price</b>	<b>≤ \$2,252 / set</b>

**CS-SSA-003: A3+ Multi - function Full - auto Card Cutter**

This full - automatic cutter is used for cutting business card, photos and various of certificate cards, etc.

- Durable blade, it's made of steel blade
- Time saving and labor saving
- Multi - function full - automatic, it's convenient to use
- High Precision, reasonable structure to ensure the card is cut accurately
- Electronic eye induction system and microcomputer control
- Unique unitary design of longitudinal cutter case, fast to replace

**▼ Specifications**

Model	CS-SSA-003
Paper Size	A3 (297mm x 420mm) (12" x 16.5"), A3+ (320mm x 480mm) (12" x 19")
Size of Name Card	(85mm / 89mm / 90mm, 55mm / 54mm) x (40mm - 250mm) (3.3" / 3.5" / 3.6", 2.2" / 2.1") x (1.6" - 9.8")
Thickness of Paper	0.2mm (0.008") (180g / m <sup>2</sup> ) - 0.35mm (0.013") (350g / m <sup>2</sup> )
Loading of Paper	12pcs
Life-span for Blade	≥ 100,000 times
Cutting Speed	100pcs / min for card
Dimensions	570mm x 540mm x 280mm (22.4" x 21.2" x 11.0")
G.W.	43kg
<b>Price</b>	<b>≤ \$2,923 / set</b>

## &gt; Photo &amp; Card Cutter

**CS-D-001: Flat Three - outlet PVC Card Cutter**

- Insert the card from any sides except the side with handle
- Smart, convenient and sharp
- Customized size is available



## ▼ Specifications

Model	CS-D-001
Size	85mm x 60mm (3.3" x 2.4")
N.W.	6.6Ib (3kg)
Price	≤ \$93 / pc

**CS-D-009: Name Card Cutter (Round Corner)**

- Cut name card with round corner
- Smart, convenient and sharp
- Customized size is available



## ▼ Specifications

Model	CS-D-009
Size	88mm x 60mm (3.5" x 2.4")
N.W.	9Ib (4.1kg)
Price	≤ \$42 / pc

**CS-D-011: Name Card Cutter (Round Corner)**

- Cut name card with round corner
- Supply various sizes
- Customized size is available

## ▼ Specifications

Model	CS-D-011
Size	86mm x 54mm (3.4" x 2.1")
N.W.	9Ib (4.1kg)
Price	≤ \$42 / pc

**CS-D-0012: PVC Card Cutter**

- Cut PVC card
- Higher pressure and bigger power
- Stable and durable
- Customized size is available

## ▼ Specifications

Model	CS-D-0012
Size	85.5mm x 54mm (3.4" x 2.1")
N.W.	28.2Ib (12.8kg)
Price	≤ \$102 / pc



CS-F-001

**CS-E Series TABLE - TYPE Photo Cutter**

- With correct and convenient orientation
- Cutting photo within the scope of 1 to 3 inch
- No rough edges on the finished products
- An ideal tool of cutting all kinds of photos

## ▼ Specifications

Model	Working Size	Angle Type	Remark	Price
CS-F-001	25mm x 25mm (0.98" x 0.98"), 30mm x 40mm (1.2" x 1.6")	Right or round corner	Many sizes	≤ \$33/pc
CS-F-002	35mm x 45mm(1.4" x 1.8"), 40mm x 54mm (1.6" x 2.1")	Right or round corner	Many sizes	≤ \$33/pc

CS-F-002





## &gt; Photo &amp; Card Cutter

**CS-E Series HAND - TYPE Photo Cutter**

- With correct and convenient orientation
- Cutting photo within the scope of 1 to 3 inch
- No rough edges on the finished products
- An ideal tool of cutting all kinds of photos

**▼ Specifications**

Model	Working Size	Angle Type	Remark	Price
CS-E-002	25mm x 25mm (0.98" x 0.98"), 32mm x 32mm (1.20" x 1.20")	Right or round corner	Many sizes	≤ \$14/pc
CS-E-003	35mm x 45mm (1.40" x 1.80"), 50mm x 50mm (1.90" x 1.90")	Right or round corner	Many sizes	≤ \$16/pc
CS-E-004	50mm x 70mm (1.90" x 2.70"), 50.8mm x 73mm (2.00" x 2.90")	Right or round corner	Many sizes	≤ \$21/pc
CS-E-005	32mm x 22mm (1.20" x 0.80"), 35mm x 45mm (1.40" x 1.80")	Right or round corner	Many sizes	≤ \$21/pc

## &gt; Laminator

Please refer to the contents on page 061 ~ 075.

**FMJ-II Series Electric Cold Laminator**

Driven by electric or manual (For option)  
 No auto rewind shafts, no need to heat, include stand  
 Available in 1000mm, 1300mm model  
 This model at a price that fit your budget and  
 guarantees a qualified result

- Electric operation. The easy speed control makes your daily job handlier.
- It comes with foot pedal with forward and reverse control to free your hands to handle the work being processed.
- This unit is great for mounting print to boards, applying application tapes, applying double side, adhesives and vinyl, save time and no hassles.

**▼ Specifications**

Model	FMJ-1000-II	FMJ-1300-II
Max. Laminating Width	1000mm (40")	1300mm (51")
Max. Laminating Thickness	15mm (0.6")	15mm (0.6")
Laminating Speed	0 - 5m (197") / min	0 - 5m (197") / min
Forward / Reverse	Yes	Yes
Foot Pedal	Yes	Yes
Roller's Diameter	90mm (3.5")	90mm (3.5")
Auto Rewind Liner Pickup	No	No
Media Core Size	3"	3"
Power	The voltage is up to the local requirement, like AC80V - 110V, AC220V - 240V, 50 / 60Hz	
Machine Weight	87kg	90kg
Machine Dimension	1160mm x 520mm x 850mm (46" x 20" x 33")	1420mm x 600mm x 995mm (60" x 24" x 39")
<b>Price</b>	<b>≤ \$674</b>	<b>≤ \$736</b>

**FMJ-650: Manual Cold Laminator**

For photographic, AD. shop and copy shop to do laminating work.

Adding a protective layer on books cover, photographic, color pages, documents, charts, drawings, and indoor advertising product.

No need to heat, no motor driving, no auto rewind shafts.

- Easy operation, simple structure.
- This model is designed for mounting and laminating inkjet prints, but is equally capable of handling photographic or any printed media.

**▼ Specifications**

Model	FMJ-650
Maximum Laminating Width	650mm (26")
Maximum Laminating Thickness	10mm (0.4")
Laminating Speed	Up to the operator
Roller's Diameter	65mm (2.6")
Floor Stand	No
Machine Weight	24kg
Machine Dimension	840mm x 350mm x 360mm (33" x 14" x 14")
<b>Price</b>	<b>≤ \$203</b>



## &gt; Laminator

**FMJ-650-II Plus: Desktop Electric Cold Laminator**

Table Top Model, driven by electric or by hand (For optional). No need to heat, no auto rewind shafts.

- The mounting master 26" is motorized table top laminators. Simple structure, portable machine.
- It comes with foot pedal with forward and reverse control to free your hands to handle the work being processed.
- The easy speed control makes your daily job more handy, laminating speed can be easily adjusted from 0 - 3m (118") / min.
- This model is designed for mounting and laminating inkjet prints, but is equally capable of handling photographic or any printed media.

**FMJ-650-II plus is upgraded from FMJ-650-II, it has all functional characteristics of FMJ-650-II, and comes with support shaft for using manual rewind the backing paper in some projects.**



FMJ-650-II



FMJ-650-II plus

## ▼ Specifications



Model	FMJ-650-II	FMJ-650-II plus
Maximum Laminator Width	650mm (26")	650mm (26")
Roller's Diameter	65mm (2.6")	65mm (2.6")
Maximum Laminating Thickness	10mm (0.4")	10mm (0.4")
Laminating Speed	From 0 to 3m (118") per minute	From 0 to 3m (118") per minute
Foot Pedal	Yes	Yes
Forward / Reverse	Yes	Yes
Auto Rewind Shafts	No	Yes
Power	110V 50 / 60HZ. 3A	110V 50 / 60HZ. 3A
Machine Weight	26kg	29.4kg
Machine Dimension	850mm x 360mm x 370mm (33" x 14" x 15")	860mm x 360mm x 370mm (34" x 14" x 15")
<b>Price</b>	<b>≤ \$255</b>	<b>≤ \$398</b>

## CS-LK-GP Series Professional Glossy Photo Paper

- The paper is coated with PE layer both sides first, the surface is brighter. Meantime it is water resistant and anti - scratch.
- Both pigment ink and water - based dye ink are suitable.
- Widely used for water - based dye or pigment ink - jet printers such as Epson, HP, Cannon, etc.



### ▼ Specifications

Model	Size	GSM	Qty	Suitable Printer	MOQ	Price
CS-LK-GP-01	A4	260g / sqm	20 sheets / parcel	Epson, HP, Cannon	10 parcels	≤ \$10.13 / parcel
CS-LK-GP-02	89mm x 127mm (3.5" x 5")	260g / sqm	100 sheets / parcel	Epson, HP, Cannon	10 parcels	≤ \$9.63 / parcel
CS-LK-GP-03	102mm x 152mm (4" x 5.9")	260g / sqm	100 sheets / parcel	Epson, HP, Cannon	10 parcels	≤ \$11.78 / parcel
CS-LK-GP-04	127mm x 178mm (5" x 7.0")	260g / sqm	100 sheets / parcel	Epson, HP, Cannon	10 parcels	≤ \$15.25 / parcel

## CS-LK-MP Series Crystal Semi - Glossy Photo Paper

- Semi - glossy, high resolution and professional prints deliver the true look and feel of traditional glossy photo - graphs.
- Scratch resistance water - resistant and quick dry surface.
- The paper is coated with PE layer both sides first, the surface is brighter. Meantime it is water resistant and anti - scratch.
- Both pigment ink and water - based dye ink are suitable.
- Widely used for water - based dye or pigment ink - jet printers such as Epson, HP, Cannon, etc.



### ▼ Specifications

Model	Size	GSM	Qty	Suitable Printer	MOQ	Price
CS-LK-MP-01	A4	260g / sqm	20 sheets / parcel	Epson, HP, Cannon	10 parcels	≤ \$10.29 / parcel
CS-LK-MP-02	89mm x 127mm (3.5" x 5.0")	260g / sqm	100 sheets / parcel	Epson, HP, Cannon	10 parcels	≤ \$9.8 / parcel
CS-LK-MP-03	102mm x 152mm (4.0" x 5.9")	260g / sqm	100 sheets / parcel	Epson, HP, Cannon	10 parcels	≤ \$11.95 / parcel
CS-LK-MP-04	127mm x 178mm (5.0" x 7.0")	260g / sqm	100 sheets / parcel	Epson, HP, Cannon	10 parcels	≤ \$15.58 / parcel

## CS-LK-LP Series Lustre Glossy Photo Paper

- Lustre glossy surface, high resolution and professional prints deliver the true look and feel of traditional glossy photo - graphs
- Scratch resistance water - resistant and quick dry surface
- The paper is coated with PE layer both sides first, the surface has functions of water resistant and anti - scratch.
- Both pigment ink and water - based dye ink are suitable.
- Widely used for water - based dye or pigment ink - jet printers such as Epson, HP, Cannon, etc.



### ▼ Specifications

Model	Size	GSM	Qty	Suitable Printer	MOQ	Price
CS-LK-LP-01	A4	260g / sqm	20 sheets / parcel	Epson, HP, Cannon	10 parcels	≤ \$10.29 / parcel
CS-LK-LP-02	89mm x 127mm (3.5" x 5.0")	260g / sqm	100 sheets / parcel	Epson, HP, Cannon	10 parcels	≤ \$9.8 / parcel
CS-LK-LP-03	102mm x 152mm (4.0" x 5.9")	260g / sqm	100 sheets / parcel	Epson, HP, Cannon	10 parcels	≤ \$11.95 / parcel
CS-LK-LP-04	127mm x 178mm (5.0" x 7.0")	260g / sqm	100 sheets / parcel	Epson, HP, Cannon	10 parcels	≤ \$15.58 / parcel

## CS-LK-WP Series Glossy Photo Paper

- Excellent image definition and color saturation.
- Short drying time.
- Both pigment ink and water - based dye ink are suitable.
- Widely used for water - based dye or pigment ink - jet printers such as Epson, HP, Cannon, etc.

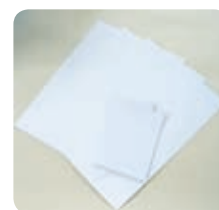

### ▼ Specifications

Model	Size	GSM	Qty	Suitable Printer	MOQ	Price
CS-LK-WP-01	A4	180g / sqm	20 sheets / parcel	Epson, HP, Cannon	10 parcels	≤ \$6.43 / parcel
CS-LK-WP-02	A4	200g / sqm	20 sheets / parcel	Epson, HP, Cannon	10 parcels	≤ \$6.53 / parcel
CS-LK-WP-03	A4	240g / sqm	20 sheets / parcel	Epson, HP, Cannon	10 parcels	≤ \$6.66 / parcel

## &gt; Photo Studio Supplies &gt; Photo laminating film

These films can add a protective layer on the photographs, pictures, illustrations, books.

They can also produce different visual or touch effects, available effects in glossy, matte, fine frosted shape, leather shape, diamond shape, wide cross shape, narrow cross shape, ellipse textile, magic shape, silk shape, stripe and so on. You can choose the right film according to your requirement.

**About Price:** The price of this product list on this book is the third ladder price. You can visit our website [www.sign-in-china.com](http://www.sign-in-china.com) for reference.

	Model	Name	Size	Price	Description
	CS-ML-H-2801-36R	Glossy Film	36" x 54Y	\$66.25 / roll	This film is transparent and especially glossy without any lines, whose clarity rate can reach 100%. After laminating the film, the photo will be brighter and have a stronger sense of glossy, even seen at different angles.
	CS-ML-H-2801-50R		50" x 54Y	\$92.06 / roll	
	CS-ML-H-2802-36R	Matte Film	36" x 54Y	\$66.25 / roll	This film is transparent on the surface and with a very delicate sense of hazy fog. After laminating the film, the photo looks more elegant and as if there are layers of mist gently separated from the pattern. This film, as the surface is composed of some super-fine sand, the sand is so small that generally the naked eye can not see any matte, if touching; we still can not feel rough, but a bit smoother.
	CS-ML-H-2802-50R		50" x 54Y	\$92.06 / roll	
	CS-ML-H-2803-36R	Fine Frosted Shape Film	36" x 54Y	\$66.25 / roll	This film is transparent but matte, it also have the frosted feeling. After laminating, we can see the picture with the frosted shape by eyes, the original picture's saw tooth will be less, even disappears, and then the picture will be more clear.
	CS-ML-H-2803-50R		50" x 54Y	\$92.06 / roll	
	CS-ML-H-2804-36R	Leather Shape Film	36" x 54Y	\$66.25 / roll	The surface has the leather-shape lines which are just like the wooden and leather. It is especially suitable for laminating the books' cover and can improve the quality of the cover. After laminating, we can see the leather texture clearly at different angles, and we will have the true and comfortable feeling of the leather.
	CS-ML-H-2804-50R		50" x 54Y	\$92.06 / roll	
	CS-ML-H-2805-36R	Diamond Shape Film	36" x 54Y	\$66.25 / roll	This film is just like the natural diamond and can show irregular rhombus pattern. As there is a large number of irregular rhombus diamond on the same surface, the film will be thicker. When laminated, it will be particular stand, more solid than the normal film. We can see the clear diamond texture at different angles, moreover, when touching, we can have strong feeling of three-dimensional diamond.
	CS-ML-H-2805-50R		50" x 54Y	\$92.06 / roll	
	CS-ML-H-2806-36R	Wide Cross Shape Film	36" x 54Y	\$66.25 / roll	This is named wide cross film, as it is composed of many interlocking cross-shaped texture. The surface looks like the woven fabrics, and the texture is close. This film is similar to the fabric patterns which are made by the machine.
	CS-ML-H-2806-50R		50" x 54Y	\$92.06 / roll	
	CS-ML-H-2807-36R	Narrow Cross Shape Film	36" x 54Y	\$66.25 / roll	This is named narrow cross film, as it is composed of many interlocking cross-shaped texture. The surface looks like the woven fabrics, and the texture is close. This film is similar to the fabric patterns which are made by the machine.
	CS-ML-H-2807-50R		50" x 54Y	\$92.06 / roll	
	CS-ML-H-2808-36R	Ellipse Textile Film	36" x 54Y	\$66.25 / roll	This film is composed of many small ellipse dots with different sizes, and the touch sense is very good.
	CS-ML-H-2808-50R		50" x 54Y	\$92.06 / roll	
	CS-ML-H-2809-36R	Dot Textile Shape Film	36" x 54Y	\$66.25 / roll	This film is composed of many broken dots with different sizes, and the touch sense is very good.
	CS-ML-H-2809-50R		50" x 54Y	\$92.06 / roll	
	CS-ML-H-2811-36R	Textile Shape Film	36" x 54Y	\$66.25 / roll	This film is composed of many lines which are composed of broken dots with the different sizes, and the lines are intertwined by the direction of latitude and longitude which makes the film is similar to the fabric patterns made by the machine. The touch sense is very good.
	CS-ML-H-2811-50R		50" x 54Y	\$92.06 / roll	

## &gt; Photo Studio Supplies &gt; Photo laminating film

These films can add a protective layer on the photographs, pictures, illustrations, books.

They can also produce different visual or touch effects, available effects in glossy, matte, fine frosted shape, leather shape, diamond shape, wide cross shape, narrow cross shape, ellipse textile, magic shape, silk shape, stripe and so on. You can choose the right film according to your requirement.

	Model	Name	Size	Price	Description
	CS-ML-H-2812-36R	Magic Shape Film	36" x 54Y	\$66.25 / roll	Someone calls it magic film, when touching it, it has a sense of subtle matte, but in the light, it can show the star magically.
	CS-ML-H-2812-50R		50" x 54Y	\$92.06 / roll	
	CS-ML-H-2813-36R	Lozenge Pearl Shape Film	36" x 54Y	\$66.25 / roll	The surface is composed of many protruded Lozenge Pearl. Seeing from different directions, you will see the small Lozenge Pearl, it has the strong three-dimensional sense and touching feeling.
	CS-ML-H-2813-50R		50" x 54Y	\$92.06 / roll	
	CS-ML-H-2814-36R	Silk Shape Film	36" x 54Y	\$66.25 / roll	This film is composed of many lines which are composed of silk cross lines with the different sizes, and the lines are intertwined by the direction of latitude and longitude which makes the film is similar as the fabric patterns made by the machine. The touch sense is very good.
	CS-ML-H-2814-50R		50" x 54Y	\$92.06 / roll	
	CS-ML-H-2815-36R	Stone & Cloud Film	36" x 54Y	\$66.25 / roll	The surface is composed of many stone and cloudy textures, and it has the strong sense of three-dimensional. After laminating, we can see the stone texture clearly even at different angle.
	CS-ML-H-2815-50R		50" x 54Y	\$92.06 / roll	
	CS-ML-H-2816-36R	Stripe Film	36" x 54Y	\$66.25 / roll	This film is composed of many vertical lines with the same distance. It can show the star pattern shinning magically. You can see the three-dimensional vertical stripes even at different angle and feel it when touching.
	CS-ML-H-2816-50R		50" x 54Y	\$92.06 / roll	
	CS-ML-H-MH24-36R	Star Laser Film	36" x 54Y	\$66.25 / roll	The film has the smooth and transparent surface, and some parts have the little and colorful particle.
	CS-ML-H-MH24-50R		50" x 54Y	\$92.06 / roll	
	CS-ML-H-MH50-36R	Plum-blossom Shape Laser Film	36" x 54Y	\$66.25 / roll	The surface is glossy and transparent, and local places hide bunches of radioactive light beam which is similar to the plum. After laminating, normally it is as clear as the 2801(without refraction) it will enhance the brightness of pictures, but seeing at different angles, you will see the plum blossom in full bloom one after another.
	CS-ML-H-MH50-50R		50" x 54Y	\$92.06 / roll	
	CS-ML-H-MH56-36R	Flame Shape Laser Film	36" x 54Y	\$66.25 / roll	The surface is glossy and transparent, and local places hide bunches of radioactive light beam which is similar to the fireworks. After laminating, normally it is as clear as the 2801(without refraction) it will enhance the brightness of pictures, but seeing from the different directions, you will see the fireworks blossom in full bloom one after another.
	CS-ML-H-MH56-50R		50" x 54Y	\$92.06 / roll	
	CS-ML-H-MH58-36R	Butterfly Shape Laser Film	36" x 54Y	\$66.25 / roll	The surface is glossy and transparent, and local places hide the pattern of butterfly. After laminating, normally it is as clear as the 2801(without refraction) it will enhance the brightness of pictures, but seeing from the different directions, you will see the butterfly flying and dancing.
	CS-ML-H-MH58-50R		50" x 54Y	\$92.06 / roll	
	CS-ML-H-MH59-36R	Heart Shape Laser Film	36" x 54Y	\$66.25 / roll	The surface is glossy and transparent, and local places hide the colorful heart-shaped pattern and circular pattern. After laminating, normally it is as clear as the 2801(without refraction) it will enhance the brightness of pictures, but seeing from the different directions, you will see the colorful hear-shaped pattern and circular pattern glittering.
	CS-ML-H-MH59-50R		50" x 54Y	\$92.06 / roll	

# 06 ADVERTISING BOARDS



Price: \$7.4 / pc  
on P358



Price: \$7.08 / pc  
on P363



Price: \$18.48 / pc  
on P359



P358 | ABS Double Color Sheet

P359 | Acrylic Board & Sheet

P363 | PVC Foam Board

## > ABS Double Color Sheet

ABS double - color plastic sheet is a kind of material for engraving, which is widely applied to production of signboard, lighting advertising board, gift arts, information board, interior decoration, commercial space sign systems and so on.

The main processing ways for double - color plastic sheet include cutting, sawing, carving, gilding, laser - treating, bending and bonding.

We can produce more than 200 colors

Thickness equal to or greater than 1.5mm, sculpture depth no more than 0.3mm

Surface thickness is 0.3mm, bottom thickness is 1.2mm

The size is 600mm x 1200mm

### Inspection standard

- Surface scratches, spots are defective.
- Tearing part of the protective film to see whether it fades, if it does, can not be used
- Comparing the color difference with a batch of same color plate number, the better the smaller color difference. When the color difference is too large, the sheet can not be used.

**About Price:** The price of this product list on this book is the third ladder price. You can visit our website [www.sign-in-china.com](http://www.sign-in-china.com) for reference.



## CS-SH-ABS Series ABS Double - color Board

- Easy cutting, sawing, stamping, engraving, laser engraving, bending and paste
- Thickness is equal to or greater than 0.1" (1.5mm), sculpture depth is no more than 0.3mm.
- Surface thickness is 0.3mm, bottom thickness is 1.2mm.
- The surface has three finishing: Frosted, gold / silver, smooth.

### ▼ Specifications (MOQ: 100pcs)

Model	CS-SH-ABS-01	CS-SH-ABS-02	CS-SH-ABS-03
Surface	Smooth	Gold / silver	Frosted
Surface Thickness	0.3mm	0.3mm	0.3mm
Bottom Thickness	1.2mm	1.2mm	1.2mm
Size (Length x Width)	1200mm x 600mm	1200mm x 600mm	1200mm x 600mm
<b>Price</b>	\$7.4 / pc \$11.3 / pc (laser engraving)	\$7.4 / pc \$13.5 / pc (laser engraving)	\$7.4 / pc \$13.5 / pc (laser engraving)



CS-SH-ABS-01

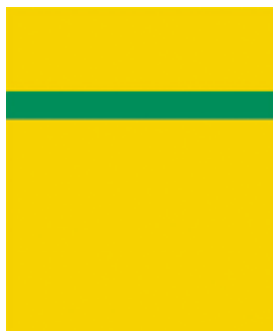

CS-SH-ABS-02



CS-SH-ABS-03

### ▼ Samples





## > Acrylic Board & Sheet

### Acrylic Clear Sheet

Mainly used for signs, lighting, display product, various types of electrical panels, indoor and outdoor decoration, construction applications, crafts, gift packaging,

functional mode, furniture and plated mirror technology.

Thickness is from 1mm to 10mm. We can also provide the super thin plate that thinner than 1mm.

Available size is 1250mm x 2500mm, special size can be made as the customers' requirement.

- The light transmission rate is high; it can be up to 92%.
- The hardness can up to 2H.
- Excellent weather resistance, corrosion resistance, difficult to break, easy processing, after long time use, the surface remains smooth and does not fade, do not yellow and crisp.
- As a result of advanced production technology and the unique monitoring and control technology, the thickness tolerances and the surface roughness has been eliminated.
- The protecting film is brown paper or PE film.
- Length tolerance is -2 / +3mm, width tolerance is -1 / +2mm, thickness tolerance is  $\pm 0.05$ mm.



**About Price:** The price of this product list on this book is the third ladder price. You can visit our website [www.sign-in-china.com](http://www.sign-in-china.com) for reference.

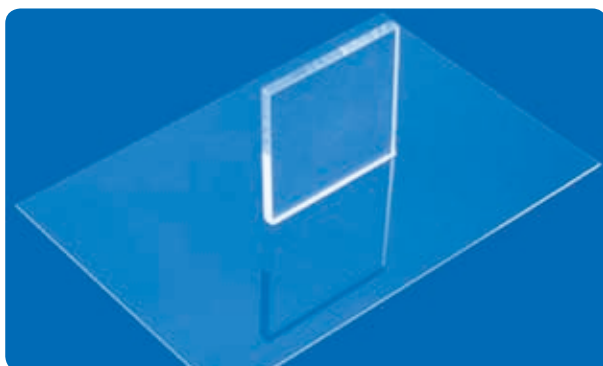

#### ▼ Specifications

Name	Size	Color	Thickness	Weight	Price
PMMA	1250mm x 2500mm	Clear	1mm	4.13kg	\$18.48 / pc
PMMA	1250mm x 2500mm	Clear	2mm	7.88kg	\$35.23 / pc
PMMA	1250mm x 2500mm	Clear	2.5mm	9.75kg	\$43.61 / pc
PMMA	1250mm x 2500mm	Clear	3mm	11.63kg	\$52.00 / pc
PMMA	1250mm x 2500mm	Clear	4mm	15.38kg	\$68.78 / pc
PMMA	1250mm x 2500mm	Clear	5mm	19.13kg	\$85.55 / pc
PMMA	1250mm x 2500mm	Clear	6mm	22.88kg	\$102.00 / pc
PMMA	1250mm x 2500mm	Clear	7mm	26.63kg	\$124.00 / pc
PMMA	1250mm x 2500mm	Clear	8mm	30.38kg	\$142.00 / pc
PMMA	1250mm x 2500mm	Clear	9mm	34.13kg	\$159.00 / pc
PMMA	1250mm x 2500mm	Clear	10mm	37.88kg	\$176.00 / pc

### Acrylic Color Sheet

Mainly used for signs, lighting, display product, various types of electrical panels, indoor and outdoor decoration, construction

applications, crafts, gift packaging, functional model and furniture.

The thickness is from 1mm to 10mm for your option.

Available size is 1250mm x 2500mm

- There are five colors: Blue, red, yellow, milky and black.
- The hardness can be up to 2H.
- Excellent weather resistance, corrosion resistance, difficult to break, easy processing, after long time use, the surface remains smooth and does not fade, do not yellow and crisp.
- The protecting is brown paper or PE film.
- Length tolerance is -2 / +3mm, width tolerance is -1 / +2mm, thickness tolerance is  $\pm 0.05$ mm.

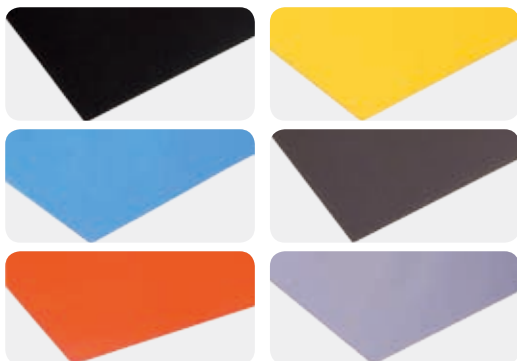

Acrylic color sheets

#### ▼ Specifications

Name	Size	Color	Thickness	Weight	Price
PMMA	1250mm x 2500mm	B / R / Y / Mi / K	1mm	4.13kg	\$27.08 / pc
PMMA	1250mm x 2500mm	B / R / Y / Mi / K	2mm	7.88kg	\$47.86 / pc
PMMA	1250mm x 2500mm	B / R / Y / Mi / K	2.5mm	9.75kg	\$59.26 / pc
PMMA	1250mm x 2500mm	B / R / Y / Mi / K	3mm	11.63kg	\$70.65 / pc
PMMA	1250mm x 2500mm	B / R / Y / Mi / K	4mm	15.38kg	\$93.45 / pc
PMMA	1250mm x 2500mm	B / R / Y / Mi / K	5mm	19.13kg	\$116.00 / pc
PMMA	1250mm x 2500mm	B / R / Y / Mi / K	6mm	22.88kg	\$139.00 / pc
PMMA	1250mm x 2500mm	B / R / Y / Mi / K	7mm	26.63kg	\$162.00 / pc
PMMA	1250mm x 2500mm	B / R / Y / Mi / K	8mm	30.38kg	\$192.00 / pc
PMMA	1250mm x 2500mm	B / R / Y / Mi / K	9mm	34.13kg	\$216.00 / pc
PMMA	1250mm x 2500mm	B / R / Y / Mi / K	10mm	37.88kg	\$239.00 / pc

## > Acrylic Board & Sheet

### Acrylic Mirror Sheet

Mainly used for mirror, vehicle mirror, bathroom mirror, dressing mirror, various types of decorative panels, etc.  
Thickness is from 1mm to 5mm.  
Available size is 1220mm x 1830mm.

- There are a lot of colors, such as silver, blue, red, yellow, Milky, black and so on.
- The surface is flat and smooth, and the hardness can be up to 2H.
- Excellent weather resistance, corrosion resistance, difficult to break, easy processing, after long time use, the surface remains smooth and does not fade, do not yellow and crisp.
- Protecting is PE film.
- Length tolerance is -2 / +3mm, width tolerance is -1 / +2mm, thickness tolerance is  $\pm 0.05$ mm.



Acrylic color sheets



#### ▼ Specifications

Name	Size	Color	Thickness	Weight	Price
PMMA	1220mm x 1830mm	Silver	1mm	2.95kg	\$25.25 / pc
PMMA	1220mm x 1830mm	Silver	1.5mm	4.29kg	\$30.89 / pc
PMMA	1220mm x 1830mm	Silver	2mm	5.63kg	\$37.63 / pc
PMMA	1220mm x 1830mm	Silver	2.5mm	6.97kg	\$44.37 / pc
PMMA	1220mm x 1830mm	Silver	3mm	8.31kg	\$51.11 / pc
PMMA	1220mm x 1830mm	Silver	4mm	10.98kg	\$64.60 / pc
PMMA	1220mm x 1830mm	Silver	5mm	13.66kg	\$78.08 / pc
PMMA	1220mm x 1830mm	Color	1mm	2.95kg	\$25.80 / pc
PMMA	1220mm x 1830mm	Color	1.5mm	4.29kg	\$31.69 / pc
PMMA	1220mm x 1830mm	Color	2mm	5.63kg	\$38.68 / pc
PMMA	1220mm x 1830mm	Color	2.5mm	6.97kg	\$45.67 / pc
PMMA	1220mm x 1830mm	Color	3mm	8.31kg	\$52.66 / pc
PMMA	1220mm x 1830mm	Color	4mm	10.98kg	\$66.64 / pc
PMMA	1220mm x 1830mm	Color	5mm	13.66kg	\$80.63 / pc

### Acrylic Square Pattern Sheet

Mainly used for decoration, lamps and lanterns, etc.  
Thickness is from 2mm to 5mm. Available size is 1250mm x 2500mm.



- Lots of transparent clear and colors board for your option, such as blue, red, yellow, brown, etc.
- The surface is square pattern veins.
- The hardness can be up to 2H.
- Excellent weather resistance, corrosion resistance, difficult to break, easy processing, after long time use, the surface remains smooth and does not fade, do not yellow and crisp.
- Thickness is from 2mm to 5mm.
- Protecting is PE film.
- Length tolerance is -2 / +3mm, width tolerance is -1 / +2mm, thickness tolerance is  $\pm 0.05$ mm.

#### ▼ Specifications

Name	Size	Color	Thickness	Weight	Price
PMMA	1250mm x 2500mm	Clear	2.4mm	6.72kg	\$40.63 / pc
PMMA	1250mm x 2500mm	Clear	2.5mm	7.09kg	\$43.06 / pc
PMMA	1250mm x 2500mm	Clear	3mm	8.97kg	\$54.24 / pc
PMMA	1250mm x 2500mm	Clear	3.5mm	10.84kg	\$65.61 / pc
PMMA	1250mm x 2500mm	Clear	4mm	12.72kg	\$76.98 / pc
PMMA	1250mm x 2500mm	Clear	5mm	16.47kg	\$99.72 / pc
PMMA	1250mm x 2500mm	Color	2.4mm	6.72kg	\$42.47 / pc
PMMA	1250mm x 2500mm	Color	2.5mm	7.09kg	\$44.84 / pc
PMMA	1250mm x 2500mm	Color	2.7mm	7.84kg	\$49.58 / pc
PMMA	1250mm x 2500mm	Color	3mm	8.97kg	\$56.69 / pc
PMMA	1250mm x 2500mm	Color	3.5mm	10.84kg	\$68.54 / pc
PMMA	1250mm x 2500mm	Color	5mm	16.47kg	\$104.00 / pc

Acrylic color sheets

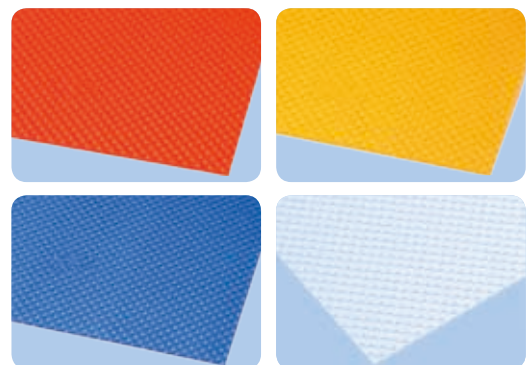

## > Acrylic Board & Sheet

### Acrylic Stripe Pattern Sheet

Mainly used for decoration, lamps and lanterns, etc. Thickness is from 2mm to 5mm.  
Available size is 1250mm x 2500mm, special size can be made according to your requirement.

- There are a lot of transparent colors and clear board for your option, such as blue, red, yellow, tea and so on.
- The surface is stripe pattern veins.
- The hardness can be up to 2H.
- Excellent weather resistance, corrosion resistance, difficult to break, easy processing, after long time use, the surface remains smooth and does not fade, do not yellow and crisp.
- The protecting is PE film.
- Length tolerance is -2 / +3mm, width tolerance is -1 / +2mm, thickness tolerance is  $\pm 0.05$ mm.



#### ▼ Specifications

Name	Size	Color	Thickness	Weight	Price
PMMA	1250mm x 2500mm	Clear	2.4mm	6.72kg	\$32.24 / pc
PMMA	1250mm x 2500mm	Clear	2.5mm	7.09kg	\$45.29 / pc
PMMA	1250mm x 2500mm	Clear	3mm	8.97kg	\$54.98 / pc
PMMA	1250mm x 2500mm	Clear	3.5mm	10.84kg	\$66.17 / pc
PMMA	1250mm x 2500mm	Clear	4mm	12.72kg	\$77.45 / pc
PMMA	1250mm x 2500mm	Clear	5mm	16.47kg	\$100.00 / pc
PMMA	1250mm x 2500mm	color	2.4mm	6.72kg	\$42.47 / pc
PMMA	1250mm x 2500mm	color	2.5mm	7.09kg	\$44.84 / pc
PMMA	1250mm x 2500mm	color	2.7mm	7.84kg	\$49.58 / pc
PMMA	1250mm x 2500mm	color	3mm	8.97kg	\$56.69 / pc
PMMA	1250mm x 2500mm	color	3.5mm	10.84kg	\$68.54 / pc
PMMA	1250mm x 2500mm	color	4mm	12.72kg	\$80.39 / pc
PMMA	1250mm x 2500mm	color	5mm	16.47kg	\$104.00 / pc

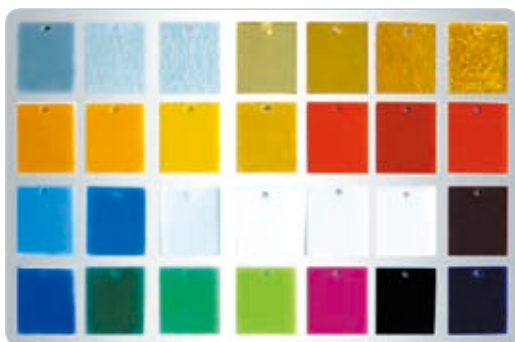

### Acrylic Pearly Pattern Sheet

Mainly used for decoration, lamps and lanterns, etc. Thickness is from 2mm to 5mm.  
Available size is 1250mm x 2500mm, special size can be made according to your requirement.



- There are a lot of transparent colors and clear board, such as blue, red, yellow, brown and so on.
- The surface is pearly pattern veins.
- The hardness can be up to 2H.
- Excellent weather resistance, corrosion resistance, difficult to break, easy processing, after long time use, the surface remains smooth and does not fade, do not yellow and crisp.
- The protecting is PE film.
- Length tolerance is -2 / +3mm, width tolerance is -1 / +2mm, thickness tolerance is  $\pm 0.05$ mm.

#### ▼ Specifications

Name	Size	Color	Thickness	Weight	Price
PMMA	1250mm x 2500mm	Clear	2mm	7.38kg	\$41.19 / pc
PMMA	1250mm x 2500mm	Clear	2.5mm	9.25kg	\$51.82 / pc
PMMA	1250mm x 2500mm	Clear	3mm	11.16kg	\$62.44 / pc
PMMA	1250mm x 2500mm	Clear	4mm	14.97kg	\$93.01 / pc
PMMA	1250mm x 2500mm	Clear	5mm	18.72kg	\$105.00 / pc
PMMA	1250mm x 2500mm	Color	2mm	7.38kg	\$44.82 / pc
PMMA	1250mm x 2500mm	Color	2.5mm	9.25kg	\$56.22 / pc
PMMA	1250mm x 2500mm	Color	3mm	11.16kg	\$67.81 / pc
PMMA	1250mm x 2500mm	Color	3.5mm	13.09kg	\$79.58 / pc
PMMA	1250mm x 2500mm	Color	4mm	14.97kg	\$90.98 / pc
PMMA	1250mm x 2500mm	Color	6mm	22.47kg	\$137.00 / pc

Acrylic color sheets



## > Acrylic Board & Sheet

### Acrylic Prismatic Pattern Sheet

Mainly used for decoration, lamps and lanterns, etc. Thickness is from 2.5mm to 10mm.  
Available size is 1250mm x 2500mm, special size can be made according to your requirement.

- There are a lot of transparent colors and clear board for your option, such as blue, red, yellow, brown and so on.
- The surface is prismatic pattern veins. The hardness can be up to 2H.
- Excellent weather resistance, corrosion resistance, difficult to break, easy processing, after long time use, the surface remains smooth and does not fade, do not yellow and crisp. The protecting is PE film.
- Length tolerance is -2 / +3mm, width tolerance is -1 / +2mm, thickness tolerance is  $\pm 0.05$ mm.

#### ▼ Specifications

Name	Size	Color	Thickness	Weight	Price
PMMA	1250mm x 2500mm	Clear	2.4mm	4.81kg	\$21.98 / pc
PMMA	1250mm x 2500mm	Clear	2.45mm	5.00kg	\$22.83 / pc
PMMA	1250mm x 2500mm	Clear	2.5mm	5.19kg	\$31.50 / pc
PMMA	1250mm x 2500mm	Clear	3mm	7.06kg	\$41.75 / pc
PMMA	1250mm x 2500mm	Clear	3.5mm	8.94kg	\$49.37 / pc
PMMA	1250mm x 2500mm	Clear	4mm	10.81kg	\$54.05 / pc
PMMA	1250mm x 2500mm	Clear	5mm	14.56kg	\$66.50 / pc
PMMA	1250mm x 2500mm	Color	2.4mm	4.81kg	\$22.90 / pc
PMMA	1250mm x 2500mm	Color	2.45mm	5.00kg	\$23.79 / pc
PMMA	1250mm x 2500mm	Color	2.5mm	5.19kg	\$24.70 / pc
PMMA	1250mm x 2500mm	Color	3mm	7.06kg	\$33.61 / pc
PMMA	1250mm x 2500mm	Color	3.5mm	8.94kg	\$51.82 / pc
PMMA	1250mm x 2500mm	Color	4mm	10.81kg	\$56.26 / pc
PMMA	1250mm x 2500mm	Color	5mm	14.56kg	\$69.30 / pc

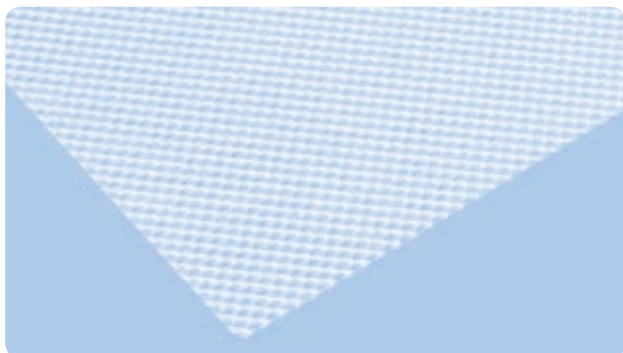

### Acrylic Orange - peel Pattern Sheet

Mainly used for decoration, lamps and lanterns, etc. Thickness is from 2mm to 10mm.  
Available size is 1250mm x 2500mm, special size can be made according to your requirement.

- There are a lot of transparent colors and clear board, such as blue, red, yellow, brown and so on.
- The surface is orange peel pattern veins, one is orange - peel empastic, and the other is orange - peel frosted. The hardness can be up to 2H.
- Excellent weather resistance, corrosion resistance, difficult to break, easy processing, after long time use, the surface remains smooth and does not fade, do not yellow and crisp.
- The protecting is PE film. Length tolerance is -2 / +3mm, width tolerance is -1 / +2mm, thickness tolerance is  $\pm 0.05$ mm.

#### ▼ Specifications

Name	Size	Color	Thickness	Price
Transparent Orange - peel Empaistic	1250mm x 2500mm	Clear	2mm	\$59.26 / pc
	1250mm x 2500mm	Clear	3mm	\$88.89 / pc
	1250mm x 2500mm	Clear	4mm	\$119.00 / pc
	1250mm x 2500mm	Clear	5mm	\$148.00 / pc
	1250mm x 2500mm	Clear	6mm	\$178.00 / pc
Transparent Orange - peel Frosted	1250mm x 2500mm	Clear	7mm	\$207.00 / pc
	1250mm x 2500mm	Clear	2mm	\$61.03 / pc
	1250mm x 2500mm	Clear	3mm	\$91.56 / pc
	1250mm x 2500mm	Clear	4mm	\$122.57 / pc
	1250mm x 2500mm	Clear	5mm	\$152.44 / pc
Color Orange - peel Empaistic	1250mm x 2500mm	Clear	6mm	\$183.34 / pc
	1250mm x 2500mm	Clear	7mm	\$213.21 / pc
	1250mm x 2500mm	Color	2mm	\$61.03 / pc
	1250mm x 2500mm	Color	3mm	\$91.56 / pc
	1250mm x 2500mm	Color	4mm	\$122.57 / pc
Color Orange - peel Frosted	1250mm x 2500mm	Color	5mm	\$152.44 / pc
	1250mm x 2500mm	Color	6mm	\$183.34 / pc
	1250mm x 2500mm	Color	7mm	\$213.21 / pc
	1250mm x 2500mm	Color	2mm	\$62.80 / pc
	1250mm x 2500mm	Color	3mm	\$94.21 / pc
Color Orange - peel Frosted	1250mm x 2500mm	Color	4mm	\$126.12 / pc
	1250mm x 2500mm	Color	5mm	\$156.86 / pc
	1250mm x 2500mm	Color	6mm	\$188.66 / pc
	1250mm x 2500mm	Color	7mm	\$219.39 / pc

Acrylic color sheets

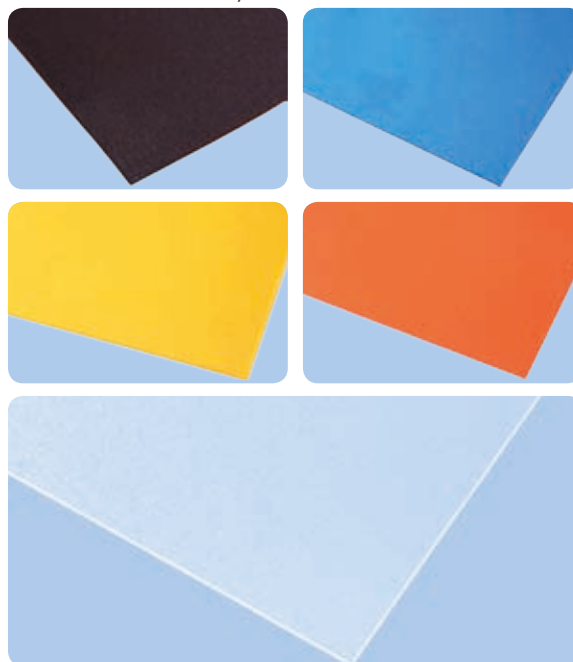

## > PVC Foam Board

### CS-SJ-PVC-FB Series A - Grade SUPER - FINE PVC Form Board

A - Grade super - fine PVC form board has a harder level surface and high density, which belongs to crust plate.

PVC foam board has a very fine and homogenous cell structure, which is the reason for its extremely flat and smooth surfaces. The board core with UV blocker increases the UV resistance. It has been designed to provide the user with perfect surfaces for a variety of applications. This is why we offer different types of sheet materials. We have 25 kinds of different thickness boards, from 1mm to 25mm. Available sizes in 1220mm x 2440mm, 1560mm x 3050mm, 2050mm x 3050mm.

- Lightweight
- Silky matte surfaces
- Homogeneous cell structure
- Difficult to ignite and self - extinguishing
- Suitable for indoor and outdoor use
- The widest range of thicknesses and sheet sizes
- Multi - color for your option, such as white and colors, such as red, black, blue, gray, etc.

#### ▼ Typical Applications

- Signage (interior and exterior)
- POS / POP displays
- Stand and exhibition booth building
- Mounting of pictures and prints
- Shop fitting and interior design
- 3 - dimensional applications

**About Price:** The price of this product list on this book is the third ladder price.

You can visit our website [www.sign-in-china.com](http://www.sign-in-china.com) for reference.

#### ▼ Specifications

Thickness	Size	Price
1mm	1220mm x 2440mm	\$7.08 / pc
2mm	1220mm x 2440mm	\$9.76 / pc
3mm	1220mm x 2440mm	\$14.52 / pc
4mm	1220mm x 2440mm	\$19.29 / pc
5mm	1220mm x 2440mm	\$23.82 / pc
6mm	1220mm x 2440mm	\$29.17 / pc
7mm	1220mm x 2440mm	\$34.04 / pc
8mm	1220mm x 2440mm	\$36.30 / pc
9mm	1220mm x 2440mm	\$39.94 / pc
10mm	1220mm x 2440mm	\$43.79 / pc
11mm	1220mm x 2440mm	\$47.20 / pc
12mm	1220mm x 2440mm	\$49.92 / pc
13mm	1220mm x 2440mm	\$56.05 / pc
14mm	1220mm x 2440mm	\$57.41 / pc
15mm	1220mm x 2440mm	\$61.26 / pc
16mm	1220mm x 2440mm	\$64.89 / pc
17mm	1220mm x 2440mm	\$73.29 / pc
18mm	1220mm x 2440mm	\$77.37 / pc
19mm	1220mm x 2440mm	\$82.37 / pc
20mm	1220mm x 2440mm	\$87.36 / pc
21mm	1220mm x 2440mm	\$90.53 / pc
22mm	1220mm x 2440mm	\$94.85 / pc
23mm	1220mm x 2440mm	\$99.16 / pc
24mm	1220mm x 2440mm	\$103.00 / pc
25mm	1220mm x 2440mm	\$107.00 / pc

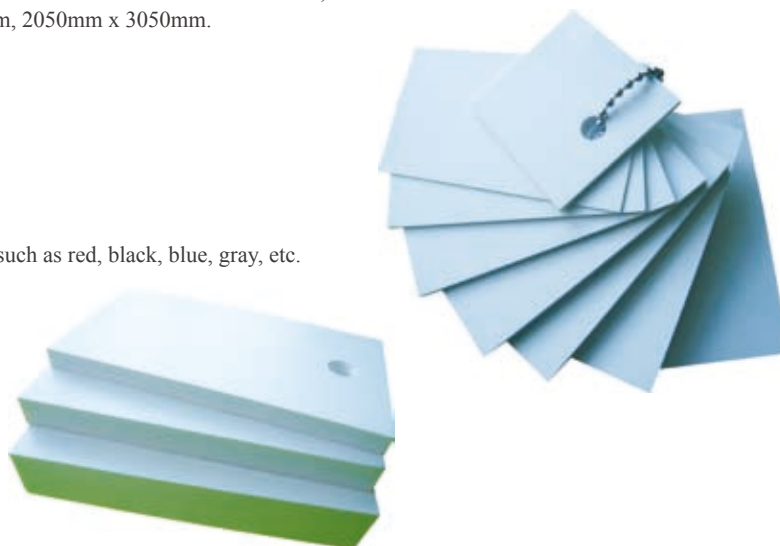

#### ▼ Specifications

Thickness	Size	Price
2mm	1560mm x 3050mm	\$17.70 / pc
3mm	1560mm x 3050mm	\$21.33 / pc
4mm	1560mm x 3050mm	\$27.91 / pc
5mm	1560mm x 3050mm	\$34.49 / pc
6mm	1560mm x 3050mm	\$41.07 / pc
8mm	1560mm x 3050mm	\$56.73 / pc
10mm	1560mm x 3050mm	\$71.25 / pc

#### ▼ Specifications

Thickness	Size	Price
2mm	2050mm x 3050mm	\$22.92 / pc
3mm	2050mm x 3050mm	\$27.91 / pc
4mm	2050mm x 3050mm	\$36.76 / pc
5mm	2050mm x 3050mm	\$45.38 / pc
6mm	2050mm x 3050mm	\$54.00 / pc

## &gt; PVC Foam Board

**CS-GW-PVC-FB Series B - Grade PVC Form Board - B**

PVC foam board has a very fine and homogenous cell structure, which is the reason for its extremely flat and smooth surface. The board core with UV blocker increases the UV resistance. It has been designed to provide the user with perfect surfaces for a variety of applications. This is why we offer different types of sheet materials.

- Exhibits brightest white
- Constant Uniform Smooth Finish
- Easily fabricated, cut and handled
- Low water absorption
- High chemical resistance
- Light weight
- Printable and can be laminated
- Good insulation
- Lower heat transmission
- Non - toxic
- Flammability - self Extinguishing



## ▼ Specifications

Thickness	Size	Price
1mm	1220mm x 2440mm	\$4.16 / pc
2mm	1220mm x 2440mm	\$5.16 / pc
3mm	1220mm x 2440mm	\$7.74 / pc
4mm	1220mm x 2440mm	\$10.32 / pc
5mm	1220mm x 2440mm	\$12.90 / pc
6mm	1220mm x 2440mm	\$17.76 / pc
7mm	1220mm x 2440mm	\$20.72 / pc
8mm	1220mm x 2440mm	\$23.68 / pc
9mm	1220mm x 2440mm	\$26.65 / pc
10mm	1220mm x 2440mm	\$29.60 / pc
11mm	1220mm x 2440mm	\$32.56 / pc
12mm	1220mm x 2440mm	\$35.52 / pc
13mm	1220mm x 2440mm	\$40.39 / pc
14mm	1220mm x 2440mm	\$43.49 / pc
15mm	1220mm x 2440mm	\$46.60 / pc
16mm	1220mm x 2440mm	\$49.71 / pc
17mm	1220mm x 2440mm	\$52.82 / pc
18mm	1220mm x 2440mm	\$55.92 / pc
19mm	1220mm x 2440mm	\$59.03 / pc
20mm	1220mm x 2440mm	\$62.14 / pc
21mm	1220mm x 2440mm	\$65.24 / pc
22mm	1220mm x 2440mm	\$68.35 / pc
23mm	1220mm x 2440mm	\$71.46 / pc
24mm	1220mm x 2440mm	\$74.64 / pc
25mm	1220mm x 2440mm	\$77.67 / pc

## ▼ Typical Applications

- **Advertising:** Signs, displays and exhibition boards, etc.
- **Construction:** Models, partitions, wall cladding, interior decoration, air conditioning ducts, etc.
- **Industry:** Control cabinets and panels, structures for corrosive environments, ducts, etc.
- **Screen Printing:** Its flat and consistent surface makes it ideal for screen printing. It is suitable for use with water - based dye and solvent inks. The surface has low absorption giving excellent ink yield.
- **Digital Printing:** It is specially designed for digital flatbed printers. All 2 - 10mm are white.

# 07 ADVERTISING SIGN MAKING



P366 | Vinyl Banner Custom Printing

P367 | Custom - made Digital Sublimation Printing

P369 | Custom - made Electroluminescent Display

P371 | Custom - made POP / POS

P374 | Custom - made Sign Letters

P377 | Custom - made Inflatable Model

## > Vinyl Banner Custom Printing

### Vinyl Banner Custom Printing

#### COMPETITIVE PRICE! A WIN - WIN INVESTMENT! MAXIMIZE YOUR PROFITS!

It is 18 years since 1995, we have been in the area of printing production and working hard for achieving the needs of our customers with the highest principles.



#### In our workroom, there are:

- Four sets of Vutek
- Two sets of local made Phaeton3206S (Width: 3.2 meters)
- Five sets of Roland FJ-540 / 740 printers
- Two sets of Roland XJ-640 printers with 1440dpi
- One set of HP 5100 indoor printer
- One set of HP UV flatbed printer
- Five sets of Mutoh
- One set of Roland Printing and Cutting machine

We provide all - round services on manufacturing finished products for our customers. We have great competition in the inkjet printing field, and meanwhile, we deal with a lot of printing businesses and the maximum printing capacity reaches 3000 square meter per day.

In addition, we have several workrooms as our partners so that to cope with large quantities or special printing business.

#### ▼ Business Scope

- **Photograph printing:** Mainly used for indoor pictures, images with delicate clarity as well as color saturation
- **Inkjet printing:** Mainly used for outdoor advertisement, waterproof and anti - ultraviolet.

#### ▼ Printing Media

- **Photograph prints:** Photo paper, PP adhesive, banner, silk canvas, non - woven, oil canvas and frontlit / backlit film
- **Inkjet prints:** Flex banner, coated mesh, self - adhesive vinyl, one way vision and coated blackout tarpaulin.



#### General Knowledge before Making Order

Once manuscript confirmed, the writings should be converted into curves or frame so as not to output garbled fonts due to different computer system. Files made to the mode of CMYK or RGB, stored in JPEG or TIFF file format, and consider keeping JPEG compression format of 10 - 12M as the best. Outdoor inkjet prints and graphic images prohibit a single black value, we must add C, M, Y colors into black as mixed black.

#### ▼ Specifications

Media	Substrates	Size	Price
Laminating Frontlit	1000 x 1000D / 20 x 20	2.5m / 2.8m / 3.2m	≤ \$17.78 / sq. m
Laminating Frontlit	1000 x 1000D / 18 x 18	2.5m / 2.8m / 3.2m	≤ \$13.33 / sq. m
Laminating Frontlit (Matte)	1000 x 1000D / 18 x 18	2.5m / 2.8m / 3.2m	≤ \$11.85 / sq. m
Laminating Backlit	1000 x 1000D / 20 x 20	2.5m / 2.8m / 3.2m	≤ \$13.33 / sq. m
Coated Backlit	500 x 500D / 18 x 12	1.52m - 3.2m	≤ \$13 / sq. m
Coated Backlit	500 x 300D / 18 x 12	1.82m - 3.2m / 4.05m / 5.0m	≤ \$14 / sq. m
Coated Backlit	500 x 300D / 18 x 12	1.82m - 3.2m	≤ \$12 / sq. m
Coated Frontlit	500 x 500D / 9 x 9	2.5m / 2.8m / 3.2m / 4.25m / 5m	≤ \$13 / sq. m
Coated Frontlit	500 x 500D / 9 x 9	2.5m / 2.8m / 3.2m	≤ \$12.5 / sq. m
Coated Frontlit	500 x 300D / 18 x 12	2.2m / 2.5m / 2.8m / 3.2m	≤ \$12 / sq. m
Coated Frontlit	500 x 200D / 18 x 12	1.62m - 1.82m / 2.02m - 3.2m	≤ \$9 / sq. m
Coated Backlit	500 x 200D / 18 x 12	1.62m - 1.82m / 2.02m - 3.2m	≤ \$9 / sq. m
Coated Frontlit	300 x 200D / 18 x 12	1.02m - 1.82m / 2.02m - 3.4m	≤ \$9 / sq. m
Coated Backlit	300 x 200D / 18 x 12	1.02m - 1.82m / 2.02m - 3.2m	≤ \$9 / sq. m
Coated Mesh	1000 x 1000D / 9 x 9	2.2m / 2.5m / 2.8m / 3.2m	≤ \$11 / sq. m
Coated Mesh (PVC base film)	1000 x 1000D / 9 x 9	2.5m / 2.8m / 3.2m	≤ \$11 / sq. m
Coated Mesh	1000 x 1000D / 9 x 13	2.5m / 3.2m	≤ \$12 / sq. m
Coated Mesh	1000 x 1000D / 9 x 16	2.5m / 3.2m	≤ \$12 / sq. m
Blockout	300 x 300D / 42 x 40	1.37m - 3.2m	≤ \$13 / sq. m
Blockout	500 x 500D / 9 x 9	2.5m / 3.2m	≤ \$11 / sq. m
Reflecting Canvas	300 x 200D	1.22m - 3.2m	≤ \$21.00 / sq. m
Silk Flag	300 x 150D	1.27m / 1.52m / 1.82m	≤ \$8.5 / sq. m
Solvent Nonwoven	300 x 300D	1.27m / 1.52m / 3.2m	≤ \$12.59 / sq. m
Transparent Flag	150 x 150D	1.27m / 1.52m	≤ \$11.85 / sq. m
Transparent Vinyl for Printing	/	1.06m - 1.52m	≤ \$11.85 / sq. m
Self-adhesive Vinyl for Vehicle	/	0.98m / 1.27m / 1.37m / 1.52m	≤ \$11.11 / sq. m
Advanced Self - adhesive Vinyl for Vehicle	/	1.06m / 1.27m / 1.52m	≤ \$13.33 / sq. m
Self - adhesive Vinyl for Vehicle (White)	/	1.06m - 2.02m	≤ \$10.15 / sq. m
Self - adhesive Vinyl for Vehicle (White)	/	1.06m - 1.52m	≤ \$10.15 / sq. m
Self - adhesive Vinyl for Vehicle (Black)	/	1.06m - 1.52m	≤ \$11.63 / sq. m
3M Self - adhesive Vinyl for Vehicle	/	/	≤ \$13 / sq. m
Poster with Blue Base Paper	/	0.914m / 1.27m / 1.52m	≤ \$11 / sq. m
Laminating Frontlit	1000 x 1000D / 20 x 20	2.5m / 2.8m / 3.2m	≤ \$17.78 / sq. m



## > Custom - made Digital Sublimation Printing

### Custom - made Digital Sublimation Printing

Our Digital Sublimation Printing Room, founded in 1985, specializes in manufacturing various sublimation printing graphics, flags, handicrafts, etc.

We have 16 sets of printing machines for different usages, including Vutek, Seiko, HP, Mimaki, Roland, Mutoh printers, etc., among which the largest printing format reaches 3.2 meters.

Meanwhile, our company possesses various professional heat transferring equipments, of which the largest format prints up to 2.75 meters wide.

**In 2008, we were honored to be designated as an authorized manufacturer for the Beijing Olympic Games.**

Our exclusive service is accessible in many countries, such as America, Germany, Australia, Norway, Canada, Japan, South Korea and other countries.



### The Process of Sublimation Printing

Sublimation Printing is a special printing technology which prints portrait, landscape or some other images on the sublimation printing paper with sublimation ink, and then heats up to certain temperatures within few minutes by heat transfer heating equipment.

The images in the paper will be transferred onto textile fabric materials with vivid color effect.

### ▼ Features of Fabric

- Green and environment - friendly product. All the fabrics we provide are 100% fully recyclable materials and the assorted sublimation ink we use is also green and environment - friendly.
- The printed picture doesn't give non irritating odor with the green sublimation ink.
- The transferred picture is inviting and attractive for its vividness when breeze goes.
- The heat transfer materials were all ironed and pressed, and thus the surface is neat and smooth and no curling.
- The material is portable that makes easy to take as a picture and convenient to packing and shipping.
- Easy to fold and no creases left that does not influence the graphic effects.
- The transferred picture is durable and keeps neat for long time, to which most materials are washable by washing machine, dry and no fading.
- Great variety and more choices for you to meet your special requirements.



## &gt; Custom - made Digital Sublimation Printing

## ▼ Applications

**Outdoor banner advertising picture and the pictures of Pop up display, Roll up stand, non - retracting banner stand, etc.**

**Needed Materials:** Tribute silk, knitting cloth - 110G, 300D oxford, knitting cloth, mesh knitting cloth, silver coating fabric.

**Price:** ≤ \$19.83

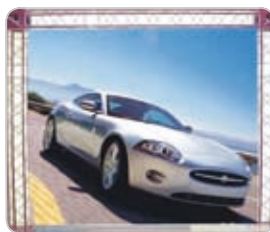
**All kinds of flags**

**Needed Materials:** 300D oxford, pongee, polar fleece

**Price:** ≤ \$39.67

**Stage background, curtain, drape, display flags and table runners**

**Needed Materials:** Stage design silk, polyester yarns, mesh knitting cloth

**Price:** ≤ \$19.83

**Handbags, slipcover, tablecloths for home decorations**

**Needed Materials:** 300D oxford, stage design silk, silver coating fabric

**Price:** ≤ \$39.67

**Customized swimwear, T - shirts, towels, fashion show clothing, etc**

**Needed Materials:** Tribute silk, knitting cloth, silver coating fabric

**Price:** ≤ \$39.67

**The surface pictures for the sporting ware / goods like skateboard**

**Price:** Refer to the heat - transferring materials.

**Mugs, plate, cap, T - shirt, etc**

**Price:** Refer to the heat press materials.

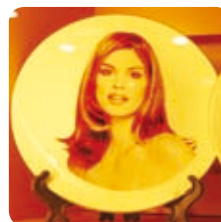

## > Custom - made Electroluminescent Display

### Custom - made Electroluminescent Display

Colorful EL (Electro Luminescent, referred as EL) whose whole surface emits light, is a kind of cold light source. It is commonly known as ultra - thin neon lights. It's a kind of green light source, not harmful and glaring to eyes.

The light is particularly bright at night, eye catching and power - saving for the feature of short - wave light and strong condensability.

Its fundamental principle of emitting light is to stimulate light - emitting materials by alternating electric field to have high - performance cold light source.

#### ▼ Motional Effects



#### ▼ Operation Principle

EL luminescence is an energy conversion device whose light source in general operating voltage could be adjusted from AC40V to AC220V and frequency from 50Hz to 4000Hz. Increasing voltage will increase the brightness, also increase the brightness if increase the frequency, meanwhile, it will change the lighting color.

The luminescence product have many advantages, such as no shadow, no dizziness, and it's with equal brightness and neon light effect. The narrow space, the complexity of the shape, restrictions of temperature and power consumption, vibration environment. EL light source makes up for the defect and impossibility of traditional light.

In addition, it's widely used for trademark, sign, election propaganda, body decorative design of the car and all kinds of backlight. EL luminescent films are excellent backlight materials. Not like conventional light sources, cold light source will not suddenly come to an end, but after a long period of using, the brightness of cold light will be gradually decreased, voltage, frequency, temperature and moisture are important factors to affect the life - span of luminescence.

#### ▼ Motional Effects



#### ▼ Main Specifications

**Weight, Thickness, Flexural Toughness:** Twists and turns are main features of EL luminescent films. Usually bending over 3cm in radius can be acceptable, and could be any shape just like papers. The average parameters are as follows, but for some special orders, and its parameters will also change accordingly.

**Average Weight:**  $0.1 \sim 0.2g / cm^2$     **Average Thickness:**  $0.4mm \sim 0.7mm$

**Seal - edge of EL:** There should be at least 0.1cm of the seal along the edge of the famous light - emitting luminescence. Reducing the size of the seal will have subtle changes in life - span, so it is necessary to maintain basically proper width when sealing.

**Colors of EL:** Luminescent films have basic standard light - emitting colors: blue green, blue, white foundation. In addition to the basic color, it can be used as bright - colored effect through a combined application of special ink and color dye film within a certain range.

**Size of EL:** Luminescent film whose single - chip size within 90cm x 90cm is customized. Single - chip size 90cm x 90cm is the largest customized size at the moment.

**Source of Power for EL - Inverter:** Having a cold light source is droved through a matching transformer designed converter (INVERTER), while drive voltage and luminescence - chip frequencies are specialized matching design and manufactured according to the size of the area - rays, light - emitting area, the applicable environment, life and other conditions.

#### ▼ Motional Effects



> Custom - made Electroluminescent Display

High energy - saving, high light - emitting, low power consumption; its green - light source is environmental and harmless for the human body.

- Flat and ultra - thin. The thickness of EL light - emitting body is only 0.2 - 0.4mm.
- El light emits even and gentle light.
- Without scattering.
- Light weight, strong randomness, It can be made into various pictures and words due to its character of bending, sticking and hanging randomly. And it is also easy to install and change for its light weight so that it saves labor cost and reduces labor intensity.
- No lighting pollution.
- High penetrability, high visibility, especially in the rain, fog, etc. Waterproof, shock - proof, long life - span; EL light - emitting is up to 8000 - 12000 hours at the normal room temperature.
- Anti - high - temperature (80°C), low temperature resistance (-40°C)



▼ Typical Application

**Backlight for panel display**

It can be widely used as display screens for a variety of computers, notebook computers, medical equipment, aviation, PDA, phone, cell phone, VCD / DVD / MP3, household appliances and other electronic appliances. It can evenly illuminate the entire screen to make it clear and soft. It also saves energy and reduces screen consumption.

**Meter industries**

It applies to automobiles, motorcycles instrumentation, defense, aviation instrumentation, a variety of high - tech digital display Instruments and needle dial.

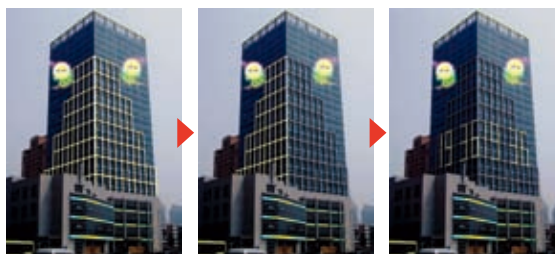

**Architecture, indoor and outdoor design**

It can be used for emergency lighting, elevator floor signs; high - rise buildings decorated landscape, hall, living room, office, and other internal decoration.

**Advertisement**

It can be used for building signs, road signs, windows, marquees advertisement, pictures display, dynamic ads, buses, aircraft, ships, automobiles and other promotional advertising categories.



**Safety**

It's used for high - rise buildings safe exit routes instructions, direct fire, public security, traffic police logo, night security and tourism directional signs, the danger zone and a series of life - saving instructions of the security - related instructions marked.

**Military & Aviation & Transport**

Map backlight can be applied to military aircraft to land at night; marks, targets, the MTR logo, identity and so on just as transport facilities for important military, aviation.

**Toys, gifts, crafts, decoration and clothing**

It's used as a variety of light sources applying for toys, electronic gifts, luminous Christmas cards, Christmas tree decorations, Christmas Lights series, luminous gloves, flashlight in hand ring, a variety of cartoon icons, badges, emblems, flashing pet collar (With lead), automotive internal and external decoration, travel caps, backpacks, handbags and so on.



## > Custom - made POP / POS

### Custom - made POP / POS

POP (Point of Purchase), sometimes people call it POS (Point of Sale) too, is made through a series producing processes such as shape design, graphic design, UV printing, multi - layer laminating with PVC, PET, PP and other plastic materials, which are mainly used as publicity displays, signs, door cards and other varieties of merchandise.

#### ▼ Products' Advantages:

- POP has a crystal clear and bright screen, it is fashionable, beautiful and durable, resilient and flat, un - deformed, all of which make it completely surpass traditional paper POP.
- It could improve the company's overall image, and become the first choice to publicize the outstanding branded product, so it has very wide scope of applications.

#### ▼ Why should you buy our product?

- We offer high quality product and good service with competitive price.
- We have a very professional design team, advanced processing plant and equipment, and have a large number of experienced and skilled front - line workers.
- Our overseas sales are professionally trained talents with work experience. We could response to the customer demand at the first time, and can give you reasonable proposals according to your demands. Professional overseas logistics management ensures a prompt and accurate delivery to customers.
- Professional overseas logistics management ensures a prompt and accurate delivery to you.

The quoted price differs greatly in accordance with your purchase quantity. Therefore, we need know your specified requirements to make a detailed quotation.



#### ▼ How to Order

- Login our website [www.Sign-in-China.com](http://www.Sign-in-China.com), click in to the page of Advertising Sign Making.
- Please kindly send us your inquiry with all your requirements. Product style, size, material and the graphic are all necessary.
- Our sales will get touch with you at the first time to communicate for all the details concerned to the product.
- Make order to our designers once everything of the product confirmed.
- Send the first draft to the clients for confirmation when it finished.
- Send order to the workshop to produce when we get the confirmation from the clients.
- The finished product delivered out.
- Logistics supervise the goods until they passed the China Custom inspection.
- Get the feedback from clients.



> Custom - made POP / POS

**Product Display**

Be applicable to MP3, digital camera, laptop, printer, mobile phone, memory storage disk laid, and so on.



**Neon Lighting**  
(The effect can be seen by Power Point)

**Material:** Optical fiber and comprehensive material.  
**Feature:** Spot light and changeable.

**Desk LED Lighting POP**

**Material:** Comprehensive material  
**Feature:** Light in whole or part of Product with high brightness.



## &gt; Custom - made POP / POS

**Card Price Label****Material:** PVC**Feature:** Write and wipe iteratively, not easily deformed and long life - span.**Swing Type****Material:** PVC and composite material.**Feature:** Dynamic, attractive and layered structure.**Exploding / Corner-stick / Shrapnel****Material:** PVC or PVC gold and silver.**Feature:** Tinsel and attractive, be matte golden and silver effect in part, and would be smarter.**Stick up way:** Paste back or shrapnel.**Promotion Items**

Display Product



## > Custom - made Sign Letters

**Channel letter** (or be called "bright light - emitting display") for Ads is with super dynamic digital control and multi - color.



It is an Ads artwork of live color and elegant taste during the day and the colorful lights shine in an orderly manner by the automatic control of the microcomputer in the night to show the unforgettable three - dimensional visual effects with an extremely strong advertising effect.

This product also has the feature of the invisible screen. That is, no graphic changing showed during daytime but it can change the effect with some graphics or words at pleasure to show in the night. It will bring people the sense of magic and interesting from the complete different contents and the stronger visual impact. These font product such as logos, images can be designed into any shape.

According to the needs of a variety of text, images can be emitted a red, orange, yellow, green, cyan, blue and purple lights, which can improve the effectiveness of advertising art more and also increase the proceeds more.

### ▼ The Structure of Bright Light - emitting Display

It is composed of three major parts: framework, filled raw material, and lamp house.

- Its framework shape use injected plastic ABS or welded metal plate material.
- The filled raw materials are the liquid resin through casting shape.
- The lamp house is the super bright LED.

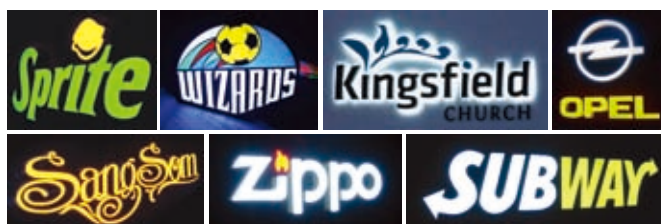

Its framework guarantees the filled materials casting and solid shape, also reflex effectively inner light to avoid light waste. The filled materials guaranteed the light penetration and even spreading. LED and electric circuits are installed inside the letter.

Through the solidified resin, LED light brings transmission, refraction, reflection, to reach excellent diffuse effect, and the light remains its brightness and uniformity during the resin penetration process.

The finished product has smooth surface and complete structure.

The luminous surface give out even bright, and colorful light. It has no joggle joint mark with the framework.



It has the feature of extra thickness, super brightness, high efficiency, energy saving, safety, long life, environment protection and so on.

**UNIFORMITY** - The special even light penetration layer to conduct light transmission, reflection function, to guarantee the surface emit uniformed light.

**SUPER BRIGHTNESS** - The luminous surface brightness can reach 500 - 1500Mcd (according to different colors)

**EXTRA THIN** - The special even light penetration layer can be within 20mm.

**EXTRA SLENDER** - Through delicate electric circuit design, the smallest width of stroke can reach 6mm.

**HIGH EFFICIENCY** - Light result is utilized to the limit through reasonable lamp allocation and the light reflex of letter inside.

**ENERGY SAVING** - LED is the lamp house; each lamp's electricity consumption is 0.1w- makes the best cost - effective.

**SAFETY-DC12V** - Low voltage work.

**LONG LIFE** - LED super long life of 100,000 - 200,000 hours provided. comprehensive protection (IP68) - Water proof, dust proof, static proof guaranteed the best working environment, to extend the lamp life to the limit. The use of long life of LED and the chemical stability of organic polymer make the LED resin letter realize long - term stability of light.

**ENVIRONMENT PROTECTION** - Antiseptic materials used, no maleficent gas volatilizes.





## &gt; Custom - made Sign Letters



## ▼ Typical Application

**Public:** Direction guide signs, emergency evacuation guide signs of stations, airport, hospital or supermarket; station plate, station name, route number, route signs of public transportation means

**Commerce:** Store front table sign, office logos, shop signs, trade mark

**Industry:** Safety production signs of plants, mines, enterprise propaganda advertisement sign

**Civil use:** Building number, floor number, home decoration lamps

The product has a very clear advertising effect of three - dimension. The Enterprises or individuals can design any advertising text, images or changing the order or color freely according to their needs. So it is not only the advisement displayed in the restaurants, hotels, karaoke dance halls, shopping malls, supermarkets, beauty salons and daily use stores, but also can be used as the production of stereotypes, large - scale outdoor advertising, mobile advertising light box, the advertising of high way, airport, bus station, port, waiting room, train, bus and roads.



## > Custom - made Sign Letters

### Custom - made Metal Letters

**The Metal letters are widely used, you can find them everywhere, they have a large market in future.**

Metal Letter, made of stainless steel, titanium - alloy or copperplate.

This technology combines the handcrafted skill of chiseling copper with modern advanced cutting equipment together to manufacture the metal letters with the special features, fancy craft and elegant style.



#### ▼ Analysis of the Metal Letter Market

The government image system, introduction of the public part scenery; community column, waiting booth, telephone booth, airport passage, the station of the subway or train, etc.

Propaganda for exhibition hall, museum, library, gymnasium, art museum, opera house, university, middle school, hospital, bank, insurance and bond, etc.

To beautify the wall of hotel, restaurant, villa, tea room, coffee bar, bar, dancing hall, gym, bakery, karaoke, sauna and beauty parlor, etc.

For conference center, exhibition center, shopping mall, supermarket, the Ads for the drinks, jewellery and cosmetics, etc.

The fitment of wedding photographic studio, building, the design of new product, show for cars, Ads for golf pub, bowling mall, and cross-country pub, etc.

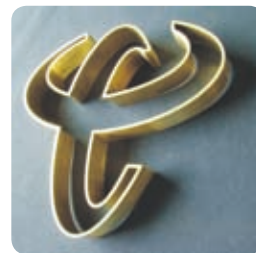
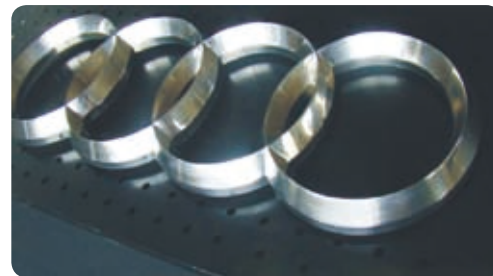

## > Custom - made Inflatable Model



### Custom - made Inflatable Model

**The Inflatable Model** is a fresh Advertising Media. Its irreplaceable advertising effect is easy to make a ceremonious scene. When it appears, it will increase people's unlimited image, arouse people's curiosity and shopping desire. It will bring the strong visual effect and happy atmosphere by the vivid appearance and can also deepen the brand effect so that the Inflatable model also has the great propaganda effect.

Nowadays, the Inflatable Model industry develops very fast. It not only can build the hot and ceremonious atmosphere, but also can reach advertising effect obviously.



### ▼ What are we doing?

#### Provide personalized product for you - MAXIMIZE PROFIT

We can manufacture the model product as for the clients' design. Our company has several factories that have strong skill staff and advanced equipment.

We can offer the unique designed, vivid and exquisite product with best material.

### ▼ Our Product Highlights

- Made of coated rip stop nylon, and advanced PVC vinyl
- Warranted for 1 year
- Washable
- Easy to setup, and be inflated in seconds
- Screen printing or digital printing available
- Ordinary Product and Product with special designs available
- Different size and color according to customer's request
- Able to produce strong visual impacts
- Smart - looking and durable



### ▼ Typical Applications

Open ceremony, new product presentation, sales promotion, wedding and birthday party, festivals activities, etc.

#### Such as

Inflatable Archway, Inflatable Bollon  
Inflatable Tube, Inflatable Cartoon  
Inflatable Sky Dancer, Inflatable AD bottle  
Inflatable Tent, Inflatable Christmas' Promotion



# Questions & Answers

This article aims to give you a brief introduction of Beijing ChinaSigns Information Co., Ltd (Hereinafter referred to as Sign-in-China.com), which owns two websites, respectively, a B2C website, [www.Sign-in-China.com](http://www.Sign-in-China.com), and an AD & signage industry website, [www.ChinaSigns.cn](http://www.ChinaSigns.cn).

- Chapter I Origin and Background of Sign-in-China.com
- Chapter II Development of Sign-in-China.com
- Chapter III How to Buy on [www.Sign-in-China.com](http://www.Sign-in-China.com)?
- Chapter IV How Does Sign-in-China.com Organize Products and Suppliers?
- Chapter V Operating Foundation and Excellent Teams of Sign-in-China.com
- Chapter VI Influence of Sign-in-China.com and Industrial Evaluation Received



## Chapter I. Origin and Background of Sign-in-China.com

### Q1-1. Is Sign-in-China.com serving as a website?

**A:** Yes, its B2C website [www.Sign-in-China.com](http://www.Sign-in-China.com), an E - commerce website, with international Business - to - Customer (B2C) model, provides purchasing services for foreign customers in the sign industry.

### Q1-2. Establishment of Sign-in-China.com

**A:** In 2003, [www.ChinaSigns.cn](http://www.ChinaSigns.cn), the Chinese website was operated for commissioning by Beijing Softimage Technology Co., Ltd. which has rich experiences of 9 years in the industry of advertising equipments and consumables. In 2006, Beijing ChinaSigns Information Co., Ltd. was established and since then we started independent operation of commercialized business and activities.

In 2007, [www.Sign-in-China.com](http://www.Sign-in-China.com), the core international website, was officially put into services. By the same time, we specially organized the Overseas Department known as the Overseas Call Center.

### Q1-3. What type of website is [www.Sign-in-China.com](http://www.Sign-in-China.com)? What is its service mode?

**A:** [www.Sign-in-China.com](http://www.Sign-in-China.com) adopts a collective mode (A B2C shopping mall) with high - quality products of the advertising industry of China, and we ensure the products with reliable quality and meet international quality standards. It has collected more than 8,000 kinds of products covering the entire AD and sign industry with most competitive and attractive prices of the market. All of our suppliers are the members of Inkjet Printing Association of PEIAC (Printing & Printing Equipment Industries Association of China).

Therefore, the product quality is respectively guaranteed by both our website and Inkjet Printing Association of China, and our company is completely responsible for all the products displayed so as to ensure your interests and benefits.



Certifications granted by Inkjet Printing Association of PEIAC.

### Q1-4. What are the differences of [www.Sign-in-China.com](http://www.Sign-in-China.com) with [www.alibaba.com](http://www.alibaba.com) and [www.globalsources.com](http://www.globalsources.com)?

**A:** Our website, [www.Sign-in-China.com](http://www.Sign-in-China.com), is based on the model of B2C shopping mall, on which all its items are reasonably priced and selected via strict quality control.

Moreover, [Sign-in-China.com](http://www.Sign-in-China.com) is in full responsibility for sale, shipment and after - sale services of our products. It provides a same comfortability and convenience as normal supermarkets carry out. Meanwhile, the product quality is duly inspected attached with warranty, and for any dissatisfaction to the quality therewith arisen from customers will be resolved via our online service. While in contrast to [www.alibaba.com](http://www.alibaba.com) and [www.globalsources.com](http://www.globalsources.com), these websites are platforms with numerous suppliers, and suitable for purchasing of single product along with each respective supplier, as a result, it causes high costs for communication and requires the customer to confirm or verify the qualities by themselves. Under such circumstances, it will be relevantly difficult to resolve once disputes arisen.

## Q1-5. What are the official organizations of sign industry in China?

**A:** At present, the national institute in China is Inkjet Printing Association of PEIAC, which is the most official association in the industry of advertising and sign production. It has more than 100 members specialized in manufacturing large format printers, inks, consumables and materials, including many important members, such as Epson, Roland, HP (China), etc. The function of this association is to formulate national standards, regulate the market, and organize international exchange programs and industrial exhibitions at home and abroad.



Mr. Liu, the CEO of Sign-in-China.com, was experiencing the intelligented equipment of Roland DG Company in 2009.



Cooperation between Inkjet Printing Association of PEIAC and Epson in 2009

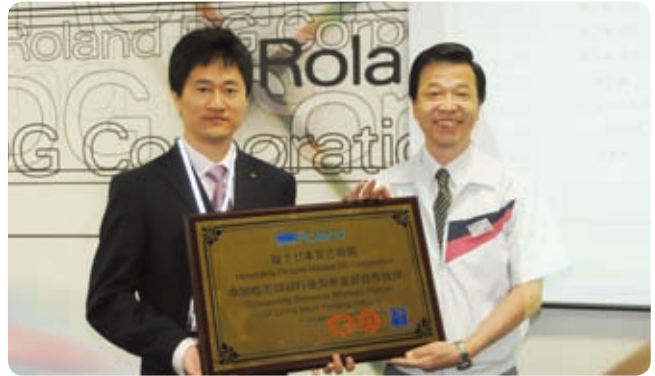

Cooperation between Inkjet Printing Association of PEIAC and Roland in 2009

## Q1-6. What is the relationship between Sign-in-China.com and Inkjet Printing Association of PEIAC?

**A:** Sign-in-China.com, as one of the committee members of Inkjet Printing Association of PEIAC, is the solely designated E-commerce website, and is also supervised, managed and instructed by the association. Thus under the authorization of this association, Sign-in-China.com serves as the Foreign Merchant Service Center that provides various business assistances for foreign merchants. Meanwhile, Sign-in-China.com has extensive social basis with more registered members than Inkjet Printing Association of China, not only specialized in the inkjet printing, but also involved in all fields of advertising production industry.

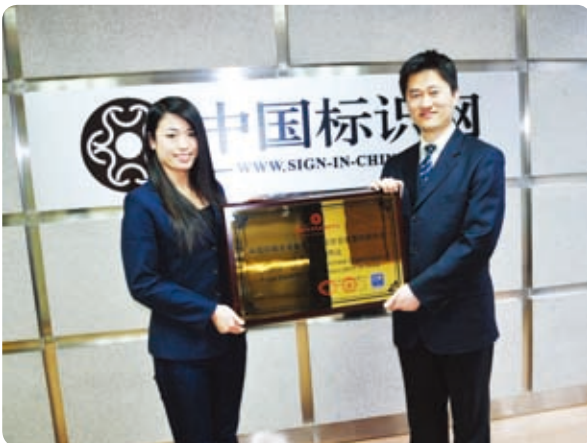

Inkjet Printing Association of PEIAC designated Sign-in-China.com as the Foreign Merchant Service Center

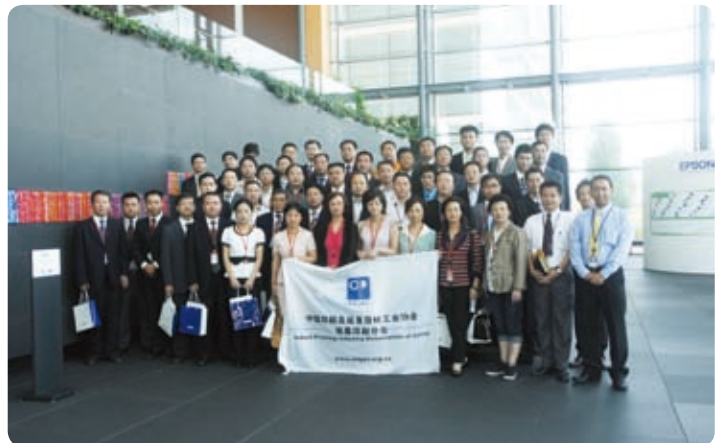

Sign-in-China.com visited Epson factory organized by Inkjet Printing Association of PEIAC

# Questions & Answers .....

## Chapter II. Development of Sign-in-China.com

### Q2-1. Memorabilia of Sign-in-China.com

#### 2007.....

**In January**, our international online website, www.Sign-in-China.com was established and started operations. By the same time, we specially organized the Overseas Department known as the Overseas Call Center.

**In May**, Sign-in-China.com organized meetings with suppliers, and nearly 100 of them signed the long term cooperation agreement.

**In August**, Sign-in-China.com established a cooperative relationship with the famous exhibition office "4nshow", and planned to take part in 16 sign exhibitions worldwide. At the same time, Sign-in-china.com started to establish the professional online sign trade shows stage.

**In October**, Sign-in-China.com was authorized by Inkjet Printing Association of PEIAC to become the Foreign Merchant Service Center.

#### 2008.....

**In January**, Sign-in-China.com featured over 1,500 products on line, covering all kinds of products in the sign industry.

**In July**, Sign-in-China.com took part in the Shanghai International Sign Exhibition, keeping a leading role in online sign trading, and we got a lot of supports in this field.

**In July**, the international version of Sign-in-China.com, Buyer Guide was issued worldwide. We set up our own showroom.

**In August**, Sign-in-China.com established a business relationship with the famous managing software supplier, NetSuite. With the high quality and stable managing software supplied by NetSuite, we can provide a full service for our buyers.

**In November**, Sign-in-China.com took part in the Italian international visual media exhibition, along with many other suppliers.



2008 - Beijing 4N Show Expo



2008 - Beijing 4N Show Expo



2008 - Experiencing Beijing Olympic Games



2008 - Media Asia Expo, Bangkok

#### 2009.....

**In December**, Sign-in-China.com announced transition into the downturn period since the global financial crisis happened in 2008.

We highlighted all of our products' potential and efficiency, and we enhanced the user experience.

**In February**, Sign-in-China.com acquired focus of companies in the sign field and VC, gaining new opportunities.

**In March**, Sign-in-China.com presented the V2 on line version. All products feature a more detailed description and provide a better user experience.

# Questions & Answers

**In April**, Sign-in-China.com attended ISA International Sign Expo 2009 in Las Vegas, Nevada, in the western USA. Picture 1

**In July**, Sign-in-China.com participated at the 17th Shanghai Int'l AD & SIGN Technology & Equipment Exhibition. Picture 2

**In September**, Sign-in-China.com attended the 51st SIGN & DISPLAY SHOW 2009 in Tokyo, Japan. Picture 3

**In October**, Sign-in-China.com attended the Media Asia Expo, in Bangkok, Thailand.

**In October**, Sign-in-China.com attended the 17th Reklama International Specialized Exhibition for Advertising in Moscow, Russia

**In November**, Sign-in-China.com attended South Korea International Advertising and Design Exhibition KOSIGN. Picture 4



Picture 1



Picture 2

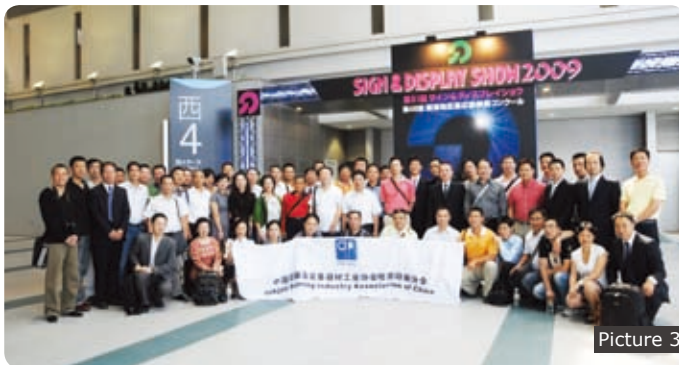

Picture 3



Picture 4

## 2010

**In January**, Sign-in-China.com participated the 12th Annual Sign & Graphic Image Middle East EXPO, Dubai. Picture 1

**In May**, Sign-in-China.com's Overseas Customer Call Center moved to a New Office.

**In May**, staff of Sign-in-China.com came to Hainan for Vacation. Picture 2

**In April**, large format printing specialist Dr. Nicholas Hellmuth visited the headquarter of Sign-in-China.com. Picture 3

**In June**, Sign-in-China.com participated the FESPA 2010 in Munich, Germany. Picture 4

**In June**, staff of Sign-in-China.com came to Jiuzhaigou for Vacation. Picture 5

**In July**, Sign-in-China.com participated at the 18th Shanghai Int'l AD & SIGN Technology & Equipment Exhibition. Picture 6, Picture 7

**In July**, Sign-in-China.com attended the 18th Media Expo in New Delhi, India. Picture 8

**In September**, Sign-in-China.com participated at the ReChina Asia Expo 2010 for Printing and Printers. Picture 9

**In October**, Sign-in-China.com attended the 18th Reklama International Specialized Exhibition for Advertising in Moscow, Russia.



Picture 1



Picture 2

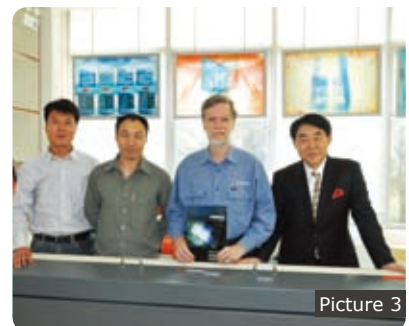

Picture 3

# Questions & Answers .....



Picture 4



Picture 5



Picture 6



Picture 7



Picture 8



Picture 9

## 2011 .....

**In April**, Sign-in-China.com attended ISA International Sign Expo 2011 in Las Vegas, USA. Picture 1

**In July**, Sign-in-China.com participated the 19th Shanghai Int'l AD & SIGN Technology & Equipment Exhibition. Picture 2

**In September**, staff of Sign-in-China.com came to Liaoning province for vacation. Picture 3

**In September**, Sign-in-China.com attended the 19th Reklama International Specialized Exhibition for Advertising in Moscow, Russia. Picture 4

**In October**, Sign-in-China.com attended a three-day exhibition of International Trade Fair for Visual Communication, Technology and Design (Viscom Expo) in Düsseldorf together with CEIEC (China Electronics International Exhibition & Advertising Co., Ltd.).



Picture 1



Picture 2



Picture 3



Picture 4



# Questions & Answers

## 2012

**In March**, Sign-in-China.com attended at 19th Reklama Polygraf Trade Fair 2012, in Prague, Czech Republic.

**In April**, Sign-in-China.com attended ISA International Sign Expo 2012 in Orlando, Florida, the USA. Picture 1

**In May**, Sign-in-China.com attended the DRUPA 2012 Expo in Düsseldorf, Germany.

**In July**, Sign-in-China.com participated at the 20th Shanghai Int'l AD & SIGN Technology & Equipment Exhibition. Picture 2

**In July**, staff of Sign-in-China.com came to the millennium town Xitang in Zhejiang province for vacation. Picture 3

**In September**, Sign-in-China.com attended the 20th Reklama International Specialized Exhibition for Advertising in Moscow, Russia. Picture 4

**In October**, Sign-in-China.com attended the United States SGIA Silk Screen Printing Digital Printing and System Phase Technology Exhibition in Las Vegas, USA. Picture 5

**In November**, Sign-in-China.com attended South Korea International Advertising and Design Exhibition KOSIGN. Picture 6



Picture 1



Picture 2



Picture 3



Picture 4

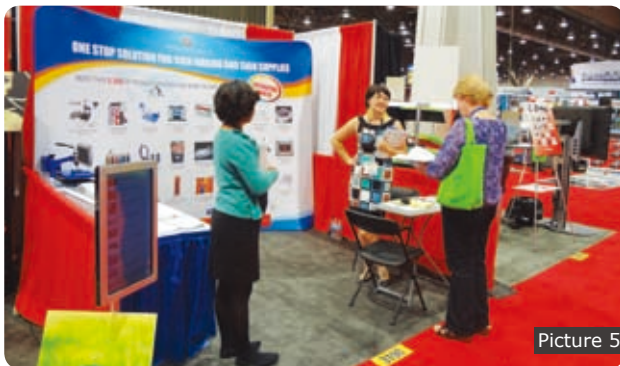

Picture 5



Picture 6

## 2013

**In July**, Sign-in-China.com's representative attended the exhibition Serigrafia Sign Future Textil 2013, Brazil. Picture 1

**In July**, the team of Sign-in-China.com came to Shanghai, China attended the 21st Shanghai Int'l Ad & Sign Technology & Equipment Exhibition. Picture 2, Picture 3

**In September**, Sign-in-China.com attended the 21st International Exhibition Reklama 2013 in Moscow. Picture 4

**In November**, Sign-in-China.com participated in The 22nd Korea International Sign & Design show KOSIGN 2014, Korea.

**In November**, Sign-in-China.com added Ocean Shipping Door-to-Door Service.

**In December**, Sign-in-China.com opened Local Service Center in Canada.

# Questions & Answers .....



## 2014.....

**In February**, Sign-in-China.com participated in 2014 D-PES Sign Expo China Guangzhou. Picture 1

**In February**, Sign-in-China.com attended International Advertising Signage Expo (Guangzhou, China). Picture 2

**In March**, Sign-in-China.com opened Local Service Center in Brazil.

**In April**, the staff of Sign-in-China.com came to Taishan Mountain in Shandong province for vacation. Picture 3

**In May**, Sign-in-China.com exposed in fair Serigrafia SIGN FutureTEXTIL 2014, Brazil. Picture 4



## Chapter III. How to Buy on www.Sign-in-China.com?

### Q3-1. Do you accept the payment by L / C?

**A:** Those qualified VIP customers who have been keeping business relationship with us for 1 year or more will be entitled to contact our sales consultants for application of payment by L / C.

### Q3-2. What kind of payment do you accept?

**A:** T/T Bank Transfer:  Paypal:  Credit Card: 

### Q3-3. What and how many products are displayed on www.Sign-in-China.com?

**A:** The total number of the products displayed on www.Sign-in-China.com is more than 10,000, which are classified into 8 main categories and 167 subclasses.

The followings are the detailed categories:

- 01 Inkjet Printing Products
- 02 Engraving Products
- 03 POP & Exhibit Displays
- 04 LED Products
- 05 Photo Studio
- 06 Advertising Boards
- 07 Advertising Sign Making
- 08 Tools & Accessories



### Q3-4. How to guarantee the repair of the item you purchased?

**A:** We provide free online consultation about all our items. If necessary, we can arrange engineer (s) to give free training at your premises while within the warranty, you will be responsible for the cost of such travelling (i.e. air ticket, board and lodging in your country, etc.). For the machines out of warranty period and if our engineer (s) is (are) required to attend at, all the fares, accommodation cost and incidental expenses shall be borne by customer, and accordingly, USD\$100 service fee shall be charged per day.

### Q3-5. Are the product prices on www.Sign-in-China.com competitive?

**A:** All the prices are FOB China and supported by our strong supply ability. In addition to the prices, we also entitle certain discounts or favorable promotions to the members who registered on www.Sign-in-China.com or filled up the membership application form on back of this brochure.

### Q3-6. What does the One Stop Solution specifically refer to?

**A:** We provide comprehensive services, such as a direct quotation, direct online - payment (direct selling), product marketing and promotion, logistics, after - sales services.

Whether you buy a single item or three 40 - foot containers that may contain hundreds of different products, you can transact all such businesses with us, for which we will implement all guarantees in accordance with the international business practices.



**The clients who were benefited from the One Stop Solution Service of Sign-in-China.com**

# Questions & Answers .....

**Aftersales service and operation training of laser marker**



**Q3-7. How to get updated product information from [www.Sign-in-China.com](http://www.Sign-in-China.com)?**

- A:** 1. Add our website into your computer browser's favorite, and can make you access it later or frequently.  
2. Register to become a member on our website as joining for free, and then we will send you newsletter weekly.  
3. Leave messages to our customer service staff so that we are able to post our latest Buyer Guide to you.

**Q3-8. Does [www.Sign-in-China.com](http://www.Sign-in-China.com) keep customer information confidential?**

**A:** Yes, we promise never to reveal your information and data to anyone else.  
You can also unsubscribe our weekly newsletter. However, we will keep your membership and you will be entitled for exclusive discount of 2%.

**Q3-9. Why can't I log in your website?**

**A:** First, please check whether your user name and password are correct, and then make sure your browser supports COOKIE.

**Q3-10. Why do I log in [www.Sign-in-China.com](http://www.Sign-in-China.com) to be a member?**

**A:** [www.Sign-in-China.com](http://www.Sign-in-China.com) has different member ranks, members may be granted with discounts from 2% to 10%. The registered members, once logged in, do not need input their contact information again when they inquire or order online. Moreover, they can check, manage and trace their orders and inquiries conducted.

**Q3-11. How about the warranty?**

**A:** For the items other than consumable products sold via [www.Sign-in-China.com](http://www.Sign-in-China.com), we provide 12 months warranty after shipment. All the extra parts for equipment can be purchased from [www.Sign-in-China.com](http://www.Sign-in-China.com). Further, for our VIP customers, the period of warranty shall be extended to 18 months.

For more information, please refer to "Customer Service & Warranty" on our website [www.Sign-in-China.com](http://www.Sign-in-China.com).

**Q3-12. What should we do after invoice confirmed?**

**A:** Based on the amount of an invoice, please release such a payment to our account, and after payment done, please inform us immediately. In the case, it is not done by instant payment, you have to provide us a copy of payment voucher, and then based on our confirmation, your order will be devolved to Logistics Department.

**Q3-13. How long will the items be shipped out after payment confirmed?**

**A:** After receiving your payment, generally we will ship out the goods within 24 to 48 working hours if there are no further special requests about the goods.

**Q3-14. How many days will I receive the item?**

**A:** Referring to the means of shipment:

Global express of delivery: 3 to 6 days

By sea transportation: Generally around 10 to 30 days depending on the destination port. (Different delivery time for different regions)

### Q3-15. How to deal with the damage problem during shipment?

**A:** Normally, we will provide you the pictures of item and packing before shipping to proof the item in good condition without damages. When you receive the item, suppose you find damage on external packing, instead of signing acceptance, please open it first and check the item inside the packing if there is any damage. If you find damage, you can definitely refuse signing acceptance and then claim loss from the express service company. At the same time, please take photos of the damaged packing and item, and contact us (either our sales consultant whom you know or send email to "service@sign-in-china.com"). Hence, our people will assist you in handling such dispute.

### Q3-16. Delivery ports

**A:** Our main delivery ports in China are Beijing, Shanghai, Guangzhou, Shenzhen, Tianjin, Dalian, where are convenient and it drops down your cost. Since the establishment of our overseas warehouses, and for convenience of certain customers therein, we have organized local delivery services in USA, Russia, Brazil and Mexico.

### Q3-17. Can I return an item if I am not satisfied with after delivery?

**A:** If you are not satisfied after receiving an item, Sign-in-China.com promises that, within 14 days after actual delivery of such an item, you are allowed to return the item to us and get complete refund, provided the returned item does not affect its subsequent re - selling and you also undertake the charge of returning delivery.

**The following situations are regarded as re - selling affected:**

- a) Its commodity package appears damage;
- b) Its commercial label or mark are scratched or removed, the item is broken, or even the consumables along with an item are already used;
- c) The original factory sealed package of the item is opened;
- d) The item that was individually produced or made according to your customized requirement or special instruction;
- e) The non - returnable item that is indicated on our website, performa invoice or in sales contract;
- f) Other factors or reasons that may affect re - selling of such item after returning;

For the item may be affected in subsequent re - selling, we will move on the process of refund or returning based upon confirmation of mutual understanding or negotiation.



### Q3-18: How about our working hours?

**A:** Referring to **our working time**, we provide 24 hours service in consideration of urgent situations. During our working time, we provide you professional and pleasure services.

### Q3-19: How to refund?

**A:** Within 5 days after delivery of an item, upon confirmation of Sign-in-China.com, we will process refund for you. For some certain special situations, it may prolong in checkup or investigation, for which we will provide you with explanation.

### Q3-20: How about packaging?

**A:** The goods sent out by us are packed by the Logistics Department, which has specific requirements for packaging goods. Therefore, we will ensure the package. If damaged package is found when you receive, please call your service consultant directly and email to service@Sign-in-China.com at the same time. Our customer service staff will help you handle the troubles.

### Q3-21: Can I purchase the products which are not displayed on your website?

**A:** Yes, you can. Please contact our sales consultant after registration, or email to service@Sign-in-China.com directly with details or requirements you request for.

## Chapter IV. How Does Sign-in-China.com Organize Products and Suppliers?

### Q4-1. What are the standards of Sign-in-China.com to select suppliers?

**A:** The general condition for becoming the supplier of Sign-in-China.com is that the supplier must be within the top factories and shall have been established more than 5 years with good reputation as well as strong capability in the industry. Usually the suppliers are members of the Association (Supervised by PEIAC). Meanwhile, Sign-in-China.com regularly visits the manufacturers, distributors and customers to ensure the general quality assessment of the products.

### Q4-2. What are the constraints for your suppliers?

**A:** Our suppliers are constrained by cooperation contracts, national laws and regulations, management and supervision by Inkjet Printing Association of PEIAC as well as public comments from the Chinese website of [www.ChinaSigns.cn](http://www.ChinaSigns.cn).

### Q4-3. What are the advantages of Sign-in-China.com for suppliers?

**A:** Strong purchasing capability assures the stably increasing orders to our suppliers. The suppliers will obtain such purchase orders without any charges. Our suppliers will not be confronted with fund pressures because of our excellent payment capability. The support of advertisements on our Chinese website is very crucial to manufacturers.

### Q4-4. What are the requirements of Sign-in-China.com for choosing products?

- A:**
1. The products must meet the quality standards required by the target market, and shall have obtained quality certifications.
  2. The products shall comply with the requirements of overseas transportation.
  3. The suppliers shall possess the accessory preparation of more than 18 months and complete on-line payment capability.
  4. The manufacturers shall maintain stable supply capability.
  5. The manufacturers shall meet the requirements of Sign-in-China.com.



The representatives of Sign-in-China.com were communicating with its suppliers for cooperation.

Sign-in-China.com supervises factories to test and inspect the quality of sold products

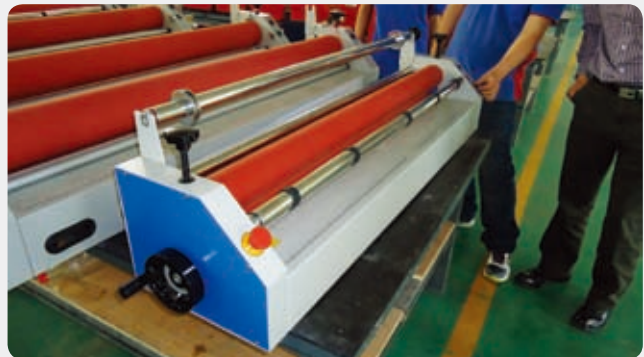

Sign-in-China.com supervises factories to monitor loading of sold products



## Q4-5. What certifications does Sign-in-China.com have?

**A:** According to the target markets for exporting purposes, Sign-in-China.com has certifications such as CE, UL, RoHS. Most of the manufacturers have obtained ISO9000 Certificate.

## Chapter V. Operating Foundation and Excellent Teams of Sign-in-China.com

### Q5-1. What does the operation team of Sign-in-China.com include?

**A:** Our operation teams consist of the Overseas Department and Product Department both with rich experiences in this industry; Network Department for operation of internet technology of our web based services; Logistics Department, Financial Department and Management Department for general administration.



Specialists from Product Department



Tree planting activity in April, 2010

### Q5-2. What are the responsibilities of the Overseas Call Center?

**A:** The Overseas Department, also known as the Overseas Call Center, consists of the international trading talents in the advertising production industry. They have excellent professional knowledge on international trading, and are able to contact our customers in English, Korean, Russian, Thai, Portuguese, Spanish, Vietnamese, etc, via the internet and phone callings. For the same purpose, they are serving as the sales consultant for customers to purchase products in China.

### Q5-3. Does Sign-in-China.com have any branches or cooperative agencies?

**A:** Sign-in-China.com has set up offices and branches with cooperators in USA, Russia, Brazil, France, Mexico, Thailand, as well as Vietnam. Meanwhile, Sign-in-China.com is seeking cooperation partners worldwide as chief representatives to handle the works of popularization, customer services and supervision, etc, and promote the products and services of Sign-in-China.com to attract more foreign local customers.

### Q5-4. In which cities has Sign-in-China.com set up logistics centers and showrooms?

**A:** Besides having set up logistics centers and showrooms in Beijing, Shenzhen of China, Sign-in-China.com has also set up the same in USA, Russia, Brazil, Mexico, Thailand, as well as Vietnam where our customers are able to take physical views of the products displayed by www.Sign-in-China.com and acquire the service of product distribution.

### Q5-5. What are the shareholders of Sign-in-China.com?

**A:** The shareholding organization of Sign-in-China.com consists of some top enterprises in the advertising production industry, financial institution, Inkjet Printing Association, cooperative corporations abroad, and our own employees. Sign-in-China.com is enlarging its shareholding organization through involving qualified investors and cooperators. More than 50% of the staff in Sign-in-China.com has become our shareholder.

## Chapter VI. Influence of Sign-in-China.com and Industrial Evaluation Received

### Q6-1. What about the current clicking ratio of Sign-in-China.com? Which countries or regions are the customers from?

**A:** Our company has sold products to more than 180 countries and regions in the past five years via our website, including remote and undeveloped areas, such as island countries in Central America as well as the Kingdom of Bhutan, a mountainous country located at the foot of Himalayan mountains.

According to the Country Chart of Weekly Independent IP Visiting Statistics of www.Sign-in-China.com, each week the visiting count reaches 117,775 times which has better effect than that of a real international exhibition.

**Country Chart for Weekly Visiting Count of Independent IP Address**

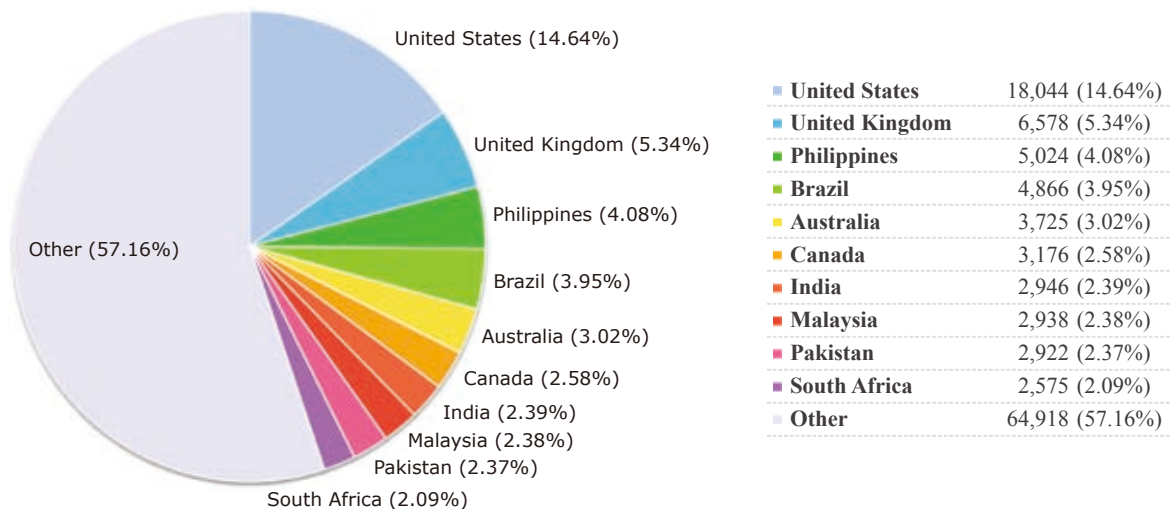

### Q6-2. What international cooperation does Sign-in-China.com have?

**A:** Sign-in-China.com has performed good and long - term cooperation with some associations, exhibitions, magazines and manufacturers overseas, especially those famous international exhibitions and sponsors, such as ISA, Reklama, Viscom, Kosign, India Media Expo, etc. Sign-in-China.com makes propaganda for Chinese enterprises via our Chinese website of www.ChinaSigns.cn and improves our overseas influence via the international exhibitions and magazines.

**Sign-in-China.com received many suggestions from Dr. Nicholas for improving the quality of our products and service.**

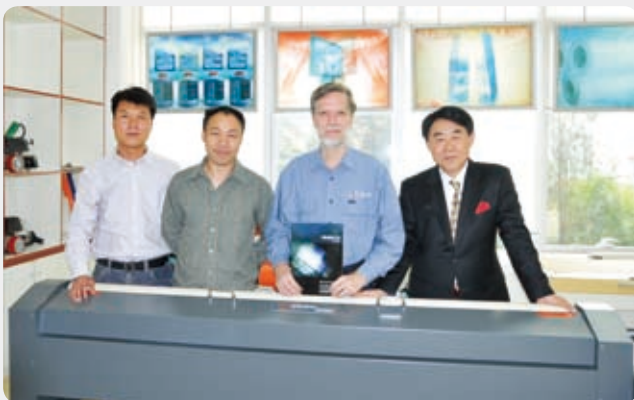





**Q6-3. What positive evaluations did Sign-in-China.com receive?**

**A:** As one of the high - tech enterprises in China, Sign-in-China.com has obtained support from the Chinese government on tax revenue. Further, Sign-in-China.com has received loan and financing support from banks as well as two investments from venture investment institutions. With these opportunities and supports, Sign-in-China.com is developing with rapid growth.



**viscom**

Paris 2014

PRINTING  
**SIGN**  
signage  
DIGITAL MEDIA  
cutting  
SERVICES  
ENGRAVING  
MARKING  
finish  
**design**  
CREATION

THERE IS NO LIMIT  
BUT YOUR  
*imagination*



*Order your free badge online  
with the code  
PP33*



INTERNATIONAL TRADE FAIR FOR  
*Visual Communication & Graphic Industry*

9, 10 & 11 SEPTEMBER 2014

*Paris, Porte de Versailles* 

PAVILION 3

Save  
the  
date!

# 2014

## FESPA CHINA & CSGIA 2014 TEXTILE PRINTING CHINA 2014

FESPA中国数码印刷展

中国国际网印及数字化印刷展/中国国际纺织品印花展



### Nov. 19 - 21, 2014

Poly World Trade Expo Center Pazhou, Guangzhou, China

2014年11月19-21日

广州琶洲保利世贸博览馆

One Theme Expo for Ad Digital Printing, Screen Printing and Textile Printing  
丝网印刷、纺织品印花、数码印刷与广告标识完美融合的主题盛会

*Future Print  
Starts Here*

**FESPA & CSGIA**

**50,000**

**SQUARE METRES**

More Than **1000** exhibitors

The 28th Brand Exhibition

[www.csgiashow.org](http://www.csgiashow.org)

[www.fespa.com](http://www.fespa.com)

Organizer:  
PTAC CSGIA FESPA  
Contractor:  
CSGIA YUEZHAN  
Support:  
ASGA

NAME: Miss Chen / Miss Li  
TEL: 010-58700604  
FAX: 010-58700577  
E-mail: [lixiaoyan@csgia.org](mailto:lixiaoyan@csgia.org)  
[shenchunyan@csgia.org](mailto:shenchunyan@csgia.org)  
ADD: 705, Building Spaces International  
Center, No. 8 Dongdaqiao Road,  
Chaoyang District, Beijing 100020, China

NAME: Miss Gu / Mr Zeng  
TEL: 020-89300178 89300188  
FAX: 020-89300198  
E-mail: [gzboya@vip.163.com](mailto:gzboya@vip.163.com)  
ADD: Room 911, ZhongZhou Trading Center,  
No1088East XinGang Road, HaiXZhu  
District, Guangzhou, China

China's Definitive Sign Event

# SIGN CHINA 2016

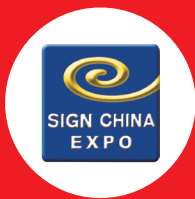

**19 - 22 September 2016**

Shanghai New International Expo Centre (SNIEC)

**The Best One-stop Sourcing Platform in Sign Industry**

Digital Printer, Printing Materials, Laser Engraver and Cutter, Signage, POP, Acrylic Panel and other Components, Digital Signage, Advertising Display, etc.

**Hall  
W1-W5  
N1**



**Hall  
E1-E5**

LED Display/Illuminant Module/Chip/Package,  
LED Lighting, other Equipment, etc.



**Pre-register online NOW and enjoy your VIP Privileges.**

Organiser

**UBM Trust Co Ltd** Tel: 86 20 3810 6261, 3810 6263 Email: sign-trust@ubm.com Website: www.SignChina-sh.com

Our Network:

USA

Tel: 1 516 562 7855

Email: cecilia.wun@ubm.com

Korea

Tel: 82 2 6715 5406

Email: jameshj.lee@ubm.com

Taiwan

Tel: 886 2 2738 3898

Email: info-tw@ubm.com

Japan

Tel: 81 3 5296 1034

Email: ubmcanonjapan@ubm.com



# Matter Matters.

We have **22** years of expertise in perfecting it.

*A Premier Magazine in Screen Printing*  
**Screen Print India**<sup>TM</sup>  
*Magazine*

www.adityaexpo.com  
www.screenprintindia.com



Success-driven leaders of today and tomorrow rely on **Screen Print India** Magazine for the need-to-know information and inspiration they can't get anywhere else.

**Aditya Publication,**

B/201, Pragee CHS, Bajaj Road, Opp. National Decorators,  
Vile Parle (W), Mumbai 400 056, India.

Tel. : +91 22 2610 0363, 2614 9984 • Fax : +91 22 2610 5689.

Email : devang@adityaexpo.com

Member of :

  
**SGAI**  
SCREENPRINTING &  
GRAPHICS ASSOCIATION OF INDIA  
*New Dimensions in Imaging*  
www.sgai.org.in

  
**SGIA**  
Specialty Graphic  
Imaging Association  
www.sgia.org

  
**ASGA**  
Asia Screen-Printing &  
Graphic Imaging Association  
www.asganet.com



# Purchase Order

<b>To</b>	Beijing ChinaSigns Information Co., Ltd	<b>From</b>	
<b>Attn</b>	Overseas Customer Call Center	<b>Attn</b>	
<b>Tel</b>	+ 86 10 63705868 ext 607	<b>Tel</b>	
<b>Fax</b>	+ 86 10 51118313	<b>Fax</b>	
<b>Add</b>	F - 4 <sup>th</sup> & 5 <sup>th</sup> , Building #8, 12 Zone, ABP, No.188, Western Road of South 4th Ring Road, Fengtai District, Beijing, China.100070	<b>Add</b>	
<b>E-mail</b>	info@Sign-in-China.com	<b>E-mail</b>	
<b>Mobile</b>	+ 86 13264103281	<b>Mobile</b>	
<b>Date</b>		<b>Date</b>	

Model	Name	Specifications	Unit Price	Qty.	Units	Total Price
<b>Total Price</b>					<b>\$</b>	
<b>Remark</b>						

<b>Other Requests</b>		<b>Signature</b>
<b>Name of Consignee</b>		
<b>Address of Consignee</b>		
<b>Contact Person</b>		
<b>Tel</b>		

- Please fill the Purchase Order if you want to buy any item in the Buyers Guide, and then you can either fax it to **+ 86 10 51118313** or scan it and send to [info@Sign-in-China.com](mailto:info@Sign-in-China.com), and our Sales Consultant will handle it.
- Alternatively, you can also visit [www.Sign-in-China.com](http://www.Sign-in-China.com) and download this Purchase Order and email it to [info@Sign-in-China.com](mailto:info@Sign-in-China.com) after filling up.



## Brief Introduction of Inkjet Printing Industries Association of China (IPIAC)

With the development of global inkjet printing technology, China's inkjet printing industry are expanding rapidly together with its' application fields. Famous overseas corporation have seen the fast development of China's inkjet printing market. Now, more and more Chinese inkjet printers have stepped into overseas market with a bright vision.

Inkjet Printing Industries Association of China (IPIAC), subsidiary of Printing and Printing Equipment Industries Association of China (PEIAC), the biggest printing association in China, was founded on May 10<sup>th</sup>, 2006 in Beijing with approval of Department of Civil Affairs.

Inkjet Printing Industries Association of China (IPIAC), subsidiary of Printing and Printing Equipment Industries Association of China (PEIAC), is the only national association for inkjet printing technology. Since its establishment, IPIAC has dedicated to the development of China's inkjet printing industry. IPIAC has more than 100 members, which include most of renowned enterprises in China's inkjet printing industry.

### Contact:

Tel: +86 10 84415375 Fax: +86 10 84415311 ext 5375

Email: wuwei@ceic.com.cn

Add: Room 808, Block A, Tianyuangang International Centre, No. 2,  
North Road of East 3rd Ring Road, Chaoyang District, Beijing, China 100027

Website: www.inkjet.org.cn



2009年度中国喷绘公司TOP100评选北京地区十佳喷绘公司

# 颁奖典礼暨专题论坛



# Registration and Free Subscription of This Brochure for Customers



Please register your information, and then take our Buyers Guide.

**Date:** \_\_\_\_\_ **Name:** \_\_\_\_\_

**Information:**

**Company:** \_\_\_\_\_

**Address:** \_\_\_\_\_

**Tel:** \_\_\_\_\_

## Your interested products:

- |  |  |
|--|--|
| <input type="checkbox"/> Inkjet Equipment      | <input type="checkbox"/> Engraving & Cutting Machine |
| <input type="checkbox"/> Cold / Hot Laminator  | <input type="checkbox"/> Inkjet Ink                  |
| <input type="checkbox"/> Inkjet Media          | <input type="checkbox"/> Inkjet Printer Accessories  |
| <input type="checkbox"/> Plastic Board / Sheet | <input type="checkbox"/> POP / Exhibit Displays      |
| <input type="checkbox"/> Photo Studio          | <input type="checkbox"/> Heat Transfer Machine       |
| <input type="checkbox"/> LED Products          | <input type="checkbox"/> Advertising Sign Making     |
| <input type="checkbox"/> Other Products: _____ |  |

## Optional information:

**MSN:** \_\_\_\_\_

**Skype:** \_\_\_\_\_

**E-mail:** \_\_\_\_\_

**Fax:** \_\_\_\_\_

## Remark:

- ✂ We promise to keep your information confidential only.
- ✂ The copy of the above form is acceptable.
- ✂ Also, you may download it from our website [www.Sign-in-China.com](http://www.Sign-in-China.com).



**Welcome to www.Sign-in-China.com! Find all your needs with an easy click!**



We have over 8,000 kinds of quality assured products covering the entire industry of AD and signage. Besides of those made in China, there are also some good quality products sourced from Japan, South Korea, Italy, etc. and every kind of product is strictly approved for you by our senior product managers.

**Company Office**



**Vast majority of our products have passed CE certification.**



**Other Certification of Our Products**



# THE WORLD'S **LARGEST** ONLINE WHOLESALER FOR ADVERTISING & SIGNAGE PRODUCTS!

- More than **10,000** super quality products for AD & Signage
- Buyers from more than **180** countries and areas.
- More than **600** purchase orders every day
- Quickest delivery to buyer just in **3** days
- **7 x 24** hours online customer service
- Instant tracking of orders at the user center
- Freight calculation of sea container for **400** ports worldwide
- Weekly Limited Time offers of **100** special priced products

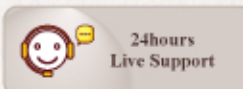
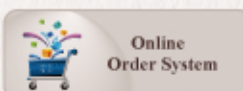

[www.Sign-in-China.com](http://www.Sign-in-China.com)

## Beijing ChinaSigns Information Co., Ltd. (Headquarters)

Email: [info@Sign-in-China.com](mailto:info@Sign-in-China.com)  
Aftersales service: [service@Sign-in-China.com](mailto:service@Sign-in-China.com)  
Skype: SigninChina02  
Tel: + 86 (10) 63705868 ext 607  
Fax: + 86 (10) 51118313  
Address: F - 4<sup>th</sup> & 5<sup>th</sup>, Building #8, Zone #12, ABP, No.188,  
Western Road of South 4th Ring Road, Fengtai District, Beijing, China 100070

## Overseas Offices and Warehouses

Europe.  
 Los Angeles, CA, USA.  
 Mexico City, Mexico.  
 São Paulo, Brazil.  
 Moscow, Russia.  
 Bangkok, Thailand.  
 Hanoi, Vietnam.

